

CREACIÓN Y EVALUACIÓN DE PICTOGRAMAS DE SEÑALIZACIÓN

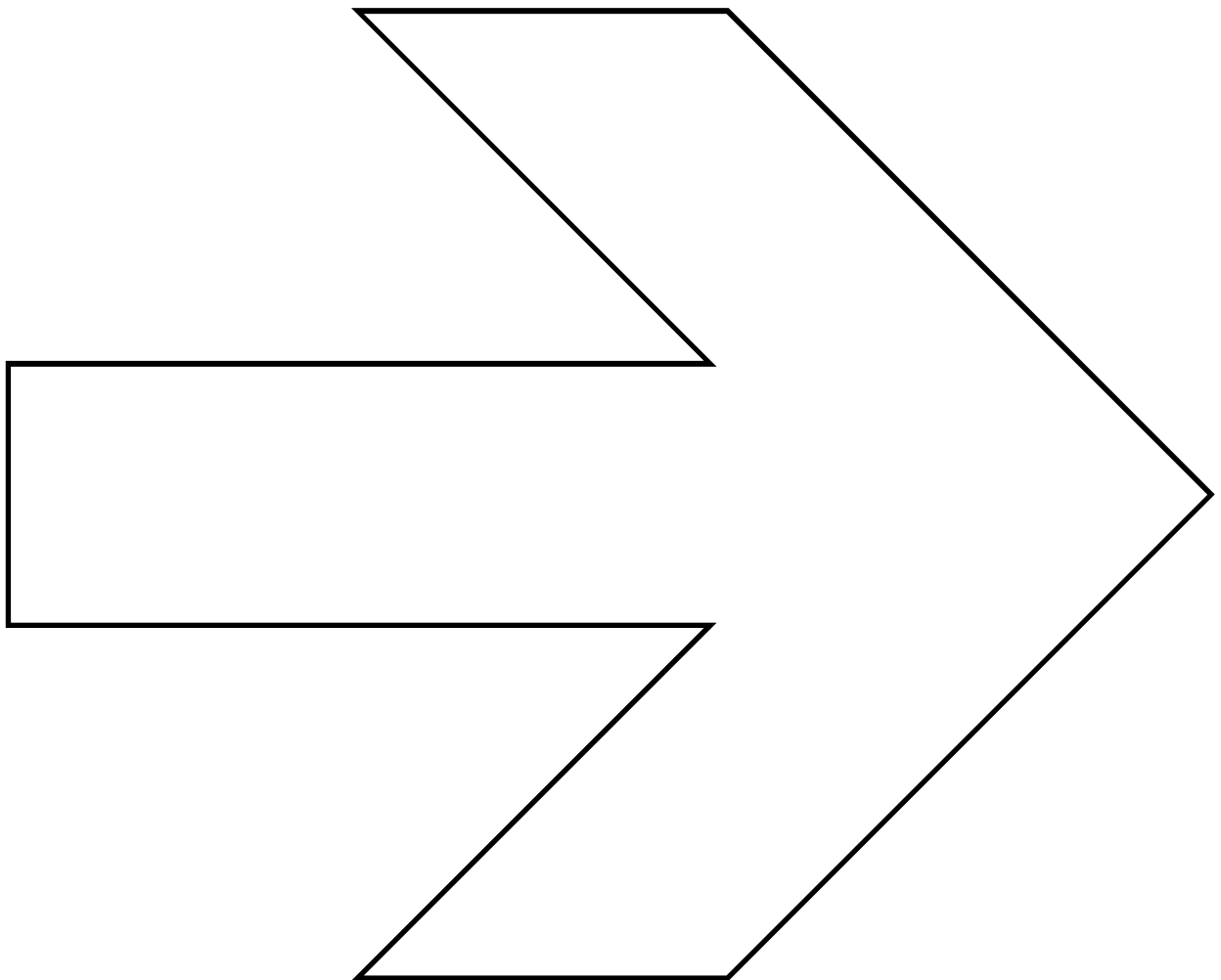

Créditos

Equipo Redactor y coordinador del proyecto

Cristina Larraz Istúriz

Rosa Regatos Soriano

Carlos Rodríguez Mahou

Margarita Sebastián Herránz

Dimas García Moreno

Diseño y maquetación

Dimas García Moreno

Edita

CEAPAT

Madrid, Junio 2018

RESUMEN

Los objetivos globales de este proyecto fueron, por una parte afianzar el uso de pictogramas en la señalización y por otra impulsar la metodología de creación de nuevos pictogramas de señalización definida en el documento: «Pautas de diseño de pictogramas para todas las personas»*. En este documento se aborda tanto el diseño como la evaluación de los pictogramas (ISO 9186-1,2).

El objetivo específico por el que el Ceapat acometió el proyecto, a lo largo de los años 2016 y 2017, fue el de dar respuesta al aumento en el número de solicitudes recibidas de asesoramiento en proyectos de señalización, que requerían de la creación de nuevos pictogramas. Esto ha permitido ampliar la Biblioteca digital de pictogramas, en formato digital, adecuadamente validados, con 53 nuevos pictogramas.

En el proceso participaron tres centros del Imserso (Instituto de Mayores y Servicios Sociales) y un centro de atención al peregrino en Santiago de Compostela.

Estos centros nos hicieron llegar los planos de sus instalaciones, remarcando las salas para las que necesitaban pictogramas.

Con esta información se llevaron a cabo talleres en estos centros, en los que profesionales y residentes, propusieron dibujos para cada referente. Estos talleres de producción supusieron una novedad respecto al proyecto inicial de la Fundación ONCE.

Con los dibujos resultantes, se elaboró un listado en el que se enumeraron elementos comunes por cada referente, y se dibujaron en el Ceapat tres propuestas esbozadas de pictograma por referente.

Estos dibujos fueron vectorizados en formato digital por estudiantes de la Universidad Rey Juan Carlos de Madrid y del Centro de Formación Profesional Tajamar.

Posteriormente, se procedió a la creación de cuadernillos para la evaluación de estimación de la comprensibilidad, ISO 9186-1. Se realizó un número extenso de evaluaciones, pero se consideró suficiente contabilizar las de 167 personas.

Con los pictogramas finalistas se llevó a cabo la evaluación de la calidad de la percepción (ISO 9186-2), realizándose un total de 100.

Los evaluadores han sido personas mayores; extranjeras; con discapacidad, física, intelectual y mental; y profesionales.

* Elaborado por el grupo de trabajo de Accesibilidad Cognitiva Urbana, liderado por la Fundación ONCE (Organización Nacional de Ciegos de España), y ahora por la Subcomisión del Cermi, y del que forma parte el Ceapat (Centro de referencia Estatal de Autonomía Personal y Ayudas Técnicas).

1. Introducción

Un entorno más comprensible y previsible, nos beneficia a todos, tanto para la orientación como para el uso de sus elementos y servicios. Todos somos analfabetos en un país en el que no hablamos el idioma; todos visitamos grandes edificios en los que nos perdemos al intentar hacer una gestión o encontrar una consulta médica; todos tenemos días en los que nos cuesta más entender la información requerida para hacer las actividades necesarias que la vida nos exige.

Una señalización clara y sencilla favorece la circulación segura y autónoma de todos. Si el mensaje solo está en texto, no será comprendido por aquellas personas que no conocen el idioma, por las que no saben leer, por aquellas que, en una situación estresante, no son capaces de interpretar este texto. La asociación texto/imagen es obligatoria en los principales puntos de la señalización. La señalización direccional necesita de esta asociación texto/imagen.

Los pictogramas de señalización tradicionales existentes son los desarrollados por AIGA (American Institute of Graphic Arts) y los incorporados a la normativa ISO (International Organization for Standardization). El sistema AIGA, ya aprendido por todos y que identificamos con la señalización, fue diseñado para ser usado en aeropuertos y otros medios de transporte en EEUU, por encargo de DOT (U.S. Department of Transportation) a AIGA. Antes de su creación, se habían desarrollado pictogramas individuales que funcionaban pero no había un sistema de pictogramas que comunicara el rango requerido de mensajes complejos, dirigidos a personas de edades y culturas diferentes y que fueran claramente legibles en la distancia. Para desarrollar este sistema se recopilaron sistemas de símbolos que habían sido usados en diferentes localizaciones en todo el mundo, y un



Figura 1. Pictogramas AIGA y muestra de la Fase Documental y de Análisis

Figura 2. Pictogramas ISO

Symbol	Concept	Description	Symbol	Feedback	Symbol Design Recommendations
	Exit	Figures walking out of open-substance	PA	2 3 1	The symbol is a walking figure of a person. It should be placed on the wall or ceiling. It should be placed at the exit of the building. It should be placed at the exit of the building. It should be placed at the exit of the building.
	Exit	Persons proceeding away from vertical bar	Q12	2 1 1	The symbol is a walking figure of a person with a wheelchair. It should be placed on the wall or ceiling. It should be placed at the exit of the building. It should be placed at the exit of the building.
	Exit	Persons proceeding away from vertical bar and pushing cart	LPC	2 1 1	The symbol is a walking figure of a person with a wheelchair and a shopping cart. It should be placed on the wall or ceiling. It should be placed at the exit of the building. It should be placed at the exit of the building.
	Exit	Persons with beds, pending to opening	Q18	2 1 1	The symbol is a walking figure of a person with a bed. It should be placed on the wall or ceiling. It should be placed at the exit of the building. It should be placed at the exit of the building.
	Exit	Persons with beds, pending to opening	EA4	2 1 1	The symbol is a walking figure of a person with a bed and a wheelchair. It should be placed on the wall or ceiling. It should be placed at the exit of the building. It should be placed at the exit of the building.



comité de cinco diseñadores gráficos del entorno, evaluó los símbolos e hizo recomendaciones para adaptarlos y rediseñarlos. Basándose en sus conclusiones, un equipo de diseñadores de AIGA desarrolló los símbolos finales.

Por lo tanto, existen pictogramas para señalar pero hacen falta más.

2. Fases del proyecto

Fase I. Documentación

Entre todas las solicitudes de asesoramiento recibidas en el Ceapat, se seleccionaron tres centros del Imsero: el Centro de Promoción de la Autonomía Personal (CPAP) de Bergondo (personas con discapacidad física y/o sensorial y con Daño Cerebral Adquirido); el Centro de Referencia Estatal de Discapacidad y Dependencia de San Andrés del Rabanedo (Personas en situación o en riesgo de dependencia y sus familiares) y el Centro de Atención a Personas con Discapacidad Física (CAMF) de Alcuéscar. Así mismo, también participó la asociación TADEGa (Tecnologías de Atención a la Diversidad en la Educación Gallega), que quería señalar un centro de atención al peregrino de Santiago de Compostela.

Como primer paso se solicitaron los planos de sus instalaciones indicando las salas o referentes para los que necesitaban un pictograma.

















Se elaboró una relación con todos los referentes de todos los centros y se hizo una primera selección de aquellos comunes a todos.

El resultado de esta selección fue de 53 referentes, de los cuales se crearon 31 pictogramas y se han modificado 20 ya existentes y evaluados según la ISO 9186 1-2.















Posteriormente, y tanto en los centros como en el Ceapat, se describieron los referentes, indicando el uso de cada una de las salas.

Para finalizar esta fase, el equipo del Ceapat realizó una búsqueda en internet de pictogramas existentes correspondientes a los referentes seleccionados. En las páginas siguientes se presentan algún ejemplo del trabajo de documentación realizado.

FASE DOCUMENTAL – DOCUMENTO DE RECOPIACIÓN

Referente	Imagen	Institución	País	Año
Almacén		Swedish Institut for Special Needs Education	Suecia	2001
				
		ERCO	Alemania	2003
		-----	Internet	2016
Archivo		Swedish Institut for Special Needs Education	Suecia	2001
		Ayuntamiento Campo de Criptana	España	2011
		-----	Internet	2016
Aula		Swedish Institut for Special Needs Education	Suecia	2001
		La Casa Encendida	España	2011
Baño incontinentes		Centro VILLAFAL	España	2014
Biblioteca		La Casa Encendida	España	2011
		Swedish Standards Institute	Suecia	2006-2007
				
		Swedish Institut for Special Needs Education	Suecia	2001
Cabina teléfono adaptada		-----	Internet	2016
		-----	Internet	2016

FASE DOCUMENTAL – DOCUMENTO DE RECOPIACIÓN

Referente	Imagen	Institución	País	Año
Cafetería		ISO 7001 Símbolos y esquemas de información pública	Internacional	2016
		Swedish Institut for Special Needs Education	Suecia	2001
		Ferrocarriles Suizos	Suiza	
		Bonnington Symbol System City of Edinburgh Council	Inglaterra	2008
Dormitorio		AIGA y United States Army Corp of Engineers	EE.UU.	1979 2006
		ISO 7001 Símbolos y esquemas de información pública	Internacional	2016
		Bonnington Symbol System City of Edinburgh Council	Inglaterra	
Sala de Fisioterapia		ERCO	Alemania	2003
		Hablamos Juntos	EE.UU.	2003
		ARASAAC	España	
Gimnasio		United States Army Corp of Engineers	EE.UU.	2006
		Centro VILLAFAL	España	2014
		http://www.shutterstock.com/		2016
				
		http://images.vectorhq.com/images/thumbs/9fc/exercise-or-gym-area-clip-art-101917.png		2016

Fase II. Producción

En todos los centros participantes, más de 100 personas entre residentes, usuarios y profesionales, llevaron a cabo el «Taller de producción de pictogramas», en el que cada persona realizó un dibujo para cada referente. Este taller no se llevó a cabo en el proyecto inicial de la Fundación Once y consideramos que aporta un valor importante ya que son las propias personas que usan los centros las que hacen la propuesta gráfica. Por otra parte, aporta gran valor al proyecto ya que se recopilan cientos de dibujos de gran interés, tanto por la interpretación que se le da a los espacios como por la creatividad que manifiestan todos los participantes.

Se recopilaron todas las propuestas en un documento más manejable, agrupándolas por salas-espacios y por centros de procedencia. En las figuras siguientes se pueden ver parte de estas propuestas y en el Anexo 1, el total de propuestas dibujadas en los Talleres de producción de pictogramas.

Muestra de propuestas gráficas de uno de los talleres de producción de pictogramas



Muestra de propuestas gráficas de uno de los talleres de producción de pictogramas

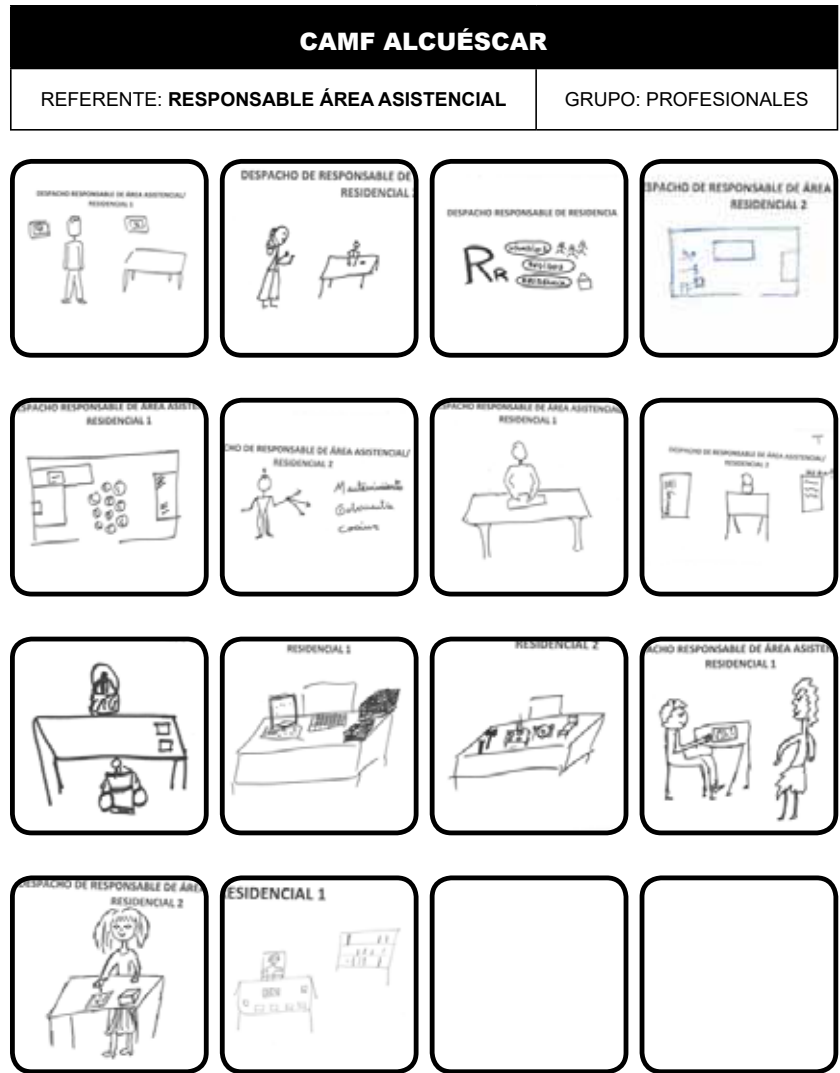

Para sintetizar toda la información aportada y facilitar la creación de tres pictogramas, se elaboró un listado con los referentes y con los elementos comunes extraídos de todas las propuestas.

Muestra de listado de referentes y sus correspondientes características comunes extraídas de los talleres de producción

Alcuescar:	Profesionales:
2 Aula de formación	Mesa con mesas, profesor, pizarra
3 Comedor residentes	Plano cenital , perspectiva, de mesas de preparadas para comer
4 Informática	Mesas con ordenador
5 Almacén	Estanterías con paquetes
6 Despacho administración	Mesas con ordenador y papeles. Algunas personas.
7 Despacho administrador	Mesa con persona papeles, dinero, no suele aparecer ordenador. Calculadora
8 Responsable Área asistencial	Mesa con papeles, y persona con división de trabajo (cubiertos, camita, cocinita,...), o de dinero. Alguna silla de ruedas.

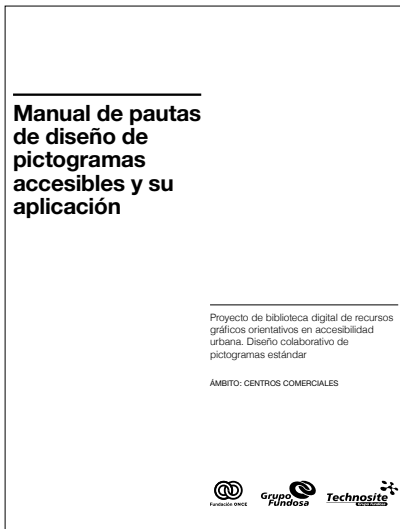

Manual de pautas de diseño de pictogramas accesibles y su aplicación, editado en formato digital por ONCE

Fase III. Diseño

En esta fase se siguió el *Manual de pautas de diseño de pictogramas accesibles y su aplicación*, elaborado por el grupo de trabajo Accesibilidad Cognitiva en el Entorno Urbano, del que reproducimos parte del contenido a continuación:

Un pictograma es un signo icónico que en su elementalidad visual transmite un significado con simplicidad y claridad, más allá de las fronteras culturales, lingüísticas o cognitivas.

El pictograma tiene las siguientes características, clasificadas atendiendo a valores conceptuales, semánticos y formales:

Conceptuales (Costa 1987)

- La finalidad de un pictograma es funcional.
- Se orienta a informar.
- El procedimiento de comunicación es visual.
- Su codificación es por signos icónicos y signos convencionales.
- Su presencia es puntual.
- Su comprensión es automática e instantánea.

Semánticas

- Formaliza referentes sobre lugares, objetos o acciones.
- Desde el punto de vista semántico, su significación debe ser unívoca.
- Se explica por sí mismo.
- Culturalmente es neutral y no puede herir sentimientos o creencias.
- Debe ser comprensible para el mayor espectro posible de personas, independientemente de su formación o capacidad intelectual.
- Permite superar barreras idiomáticas.
- Su interpretación, en ocasiones, se produce por convención social o por insistencia en su difusión.

Formales

- Debe tener carácter de signo y no de ilustración.
- Debe ser fácilmente memorizables (de formas simples y de captación instantánea).
- Su configuración formal debe ser sintética.
- Puede tener una base estructural, modular y serial.
- Su base sintáctica debe regirse por una serie de reglas de construcción que mantengan la coherencia visual del conjunto (partiendo de la idea de que un pictograma es parte de un sistema).
- En su definición se deben estudiar criterios y comportamientos para tamaños, grosores, espacios, etc., y de resistencia al deterioro visual (desenfocado, si-

mulación de percepción a distancia, lateralización, dimensiones mínimas, etc.).

- Para su percepción se debe tener en cuenta que sus formas y contrastes cromáticos estén bien definidos y se perciban de forma inmediata.
- Se debe estudiar convenientemente la relación distancia de lectura/tamaño del pictograma.
- Cuando sea necesario se puede utilizar código cromático, no obstante éste se debe reducir al mínimo.
- La representación de un pictograma es esencialmente plana y ausente de perspectiva. Sólo en casos estrictamente necesarios, para la comprensión del referente, se puede utilizar la perspectiva.
- Se debe evitar la utilización de caracteres tipográficos o leyendas escritas en la medida de lo posible.

A partir del listado de características de referentes se diseñaron en el Ceapat, tres pictogramas por referente, con un total 150 propuestas. A continuación se muestran algunos ejemplos de los dibujos realizados.

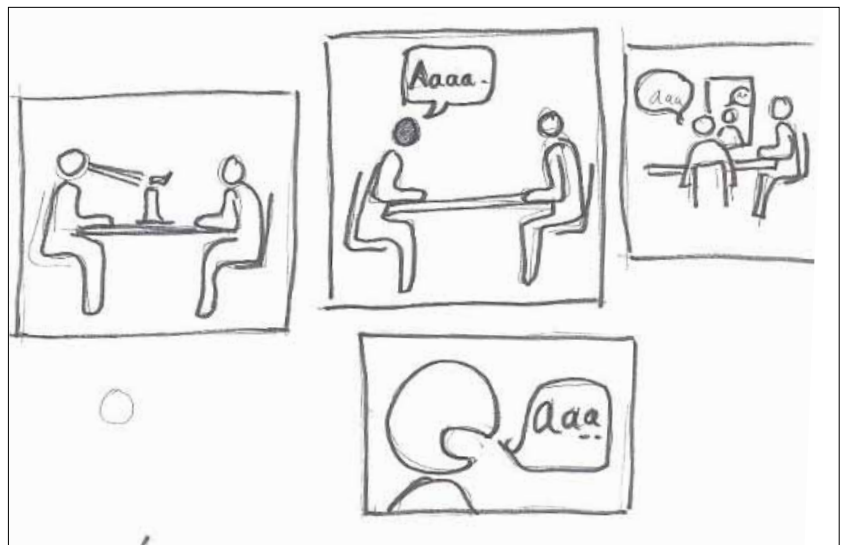
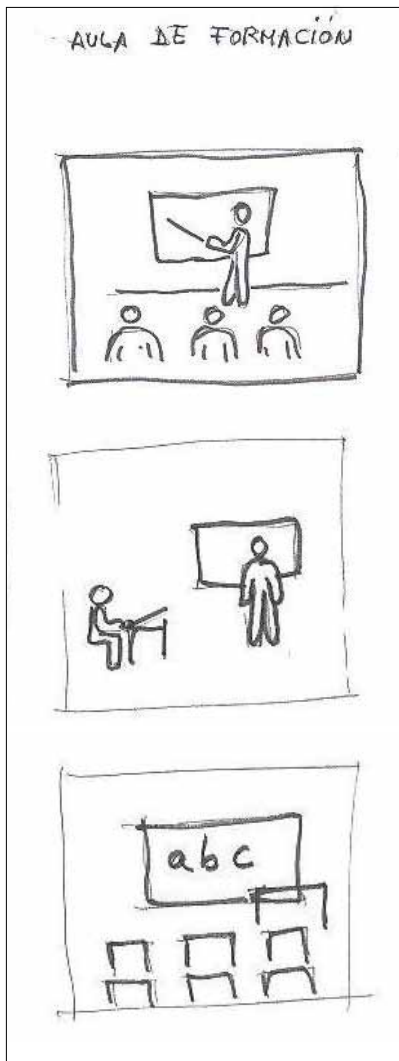

Logopedia

Información / Consejería

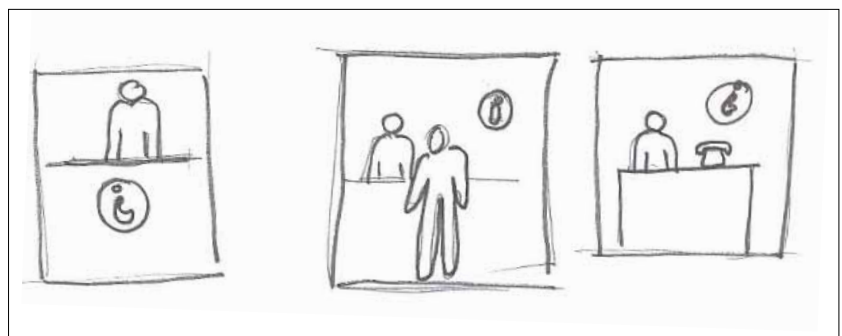

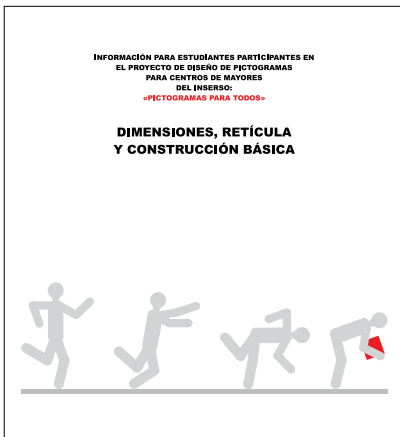

Documento de información, y página de muestra, elaborado específicamente para los estudiantes que participaron en el proyecto

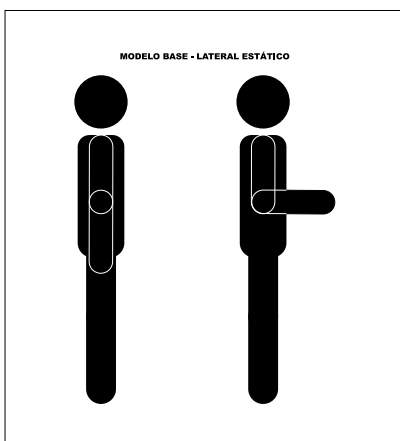

Con el fin de pasar los pictogramas propuestos a un formato de diseño digital vectorizado, fácilmente manipulable y replicable, se implicó en el proyecto a:

- Estudiantes de la Universidad Rey Juan Carlos de Madrid:
 - Grado en Fundamentos de la Arquitectura
 - Grado en Diseño Integral y Gestión de la Imagen
 - Grado en Bellas Artes
 - Grado en Diseño y Gestión de Moda
 - Grado en Paisajismo
- Estudiantes de 1º año del ciclo de grado superior de DE-PIM (Diseño y Edición de Publicaciones Impresas y Multimedia) del centro de Formación Profesional Tajamar.

Todos recibieron formación a través de una charla en la que se presentó el proyecto y se impartieron conceptos técnicos por parte del diseñador gráfico que colaboró con el equipo del Ceapat.

En paralelo con el desarrollo del proyecto, se elaboraron soluciones pictográficas para la oficina de atención al peregrino de Santiago de Compostela, con ejemplos digitalizados como los que se muestran a continuación.



Ejemplo de pictogramas vectorizados

Fase IV. Evaluación ISO 9186-1

Se tradujo la norma ISO 9186. Parte 1. *Método de evaluación: Estimación de la Comprensibilidad* y Parte 2: *Método de Evaluación de la Calidad Perceptual*.

Para la realización de la Parte 1, se proporcionaron cuadernillos, donde en cada página se presentaban tres propuestas de pictograma, A, B, C, para un mismo referente y su descripción.

Se les explicó a los evaluadores el contexto en el que se iban a encontrar estos pictogramas y se les pidió que valoraran cada una de las tres propuestas según la consideraran MUY, BASTANTE o POCO comprensible.

Si bien en la norma ISO se pide que estimen el porcentaje de personas que, en su opinión, entenderían cada propuesta, se consideró que esta tarea podía resultar demasiado complicada de entender para algunas personas evaluadoras. Por ello el equipo consensuó el siguiente procedimiento de evaluación:

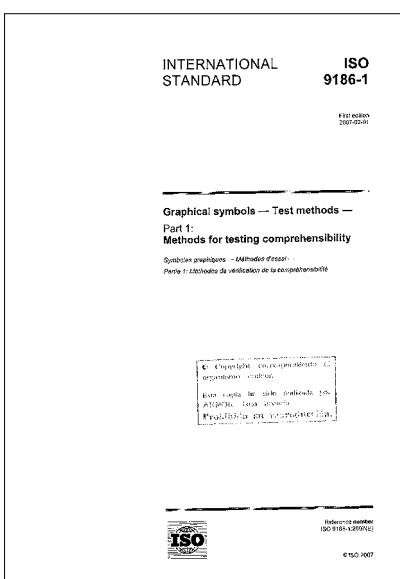

- la respuesta **MUY COMPENSIBLE** equivaldría a que el evaluador considera que el 100% de las personas entenderían este pictograma en el contexto dado;
- la respuesta **BASTANTE COMPENSIBLE** equivaldría a que el evaluador considera que el 70% de las personas entenderían este pictograma en el contexto dado;
- la respuesta **POCO COMPENSIBLE** significa que el evaluador considera que el 0% de las personas entenderían este pictograma en el contexto dado.

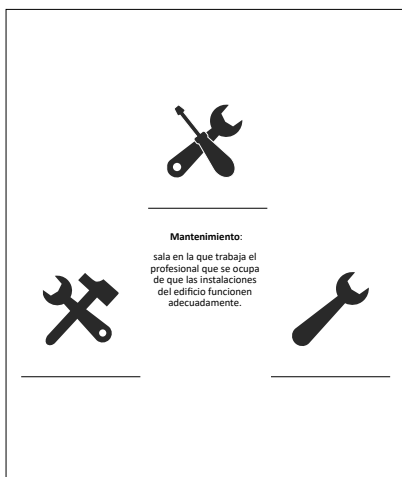
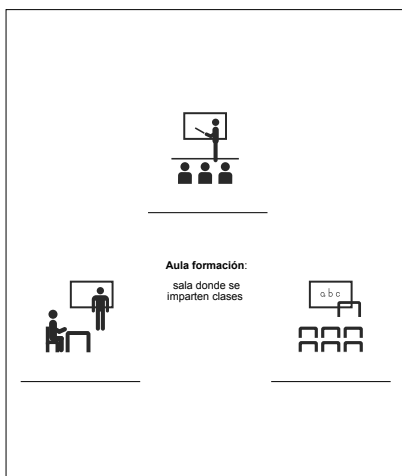
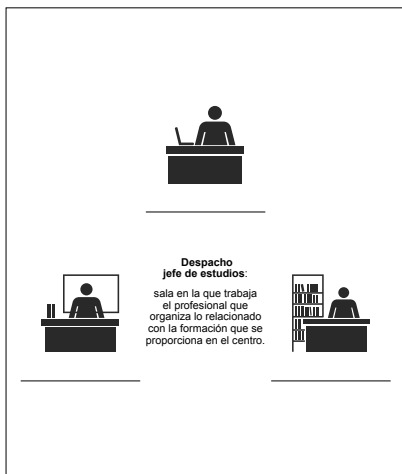

Muestras de páginas del cuadernillo de evaluación por el método de Estimación de la Comprensibilidad

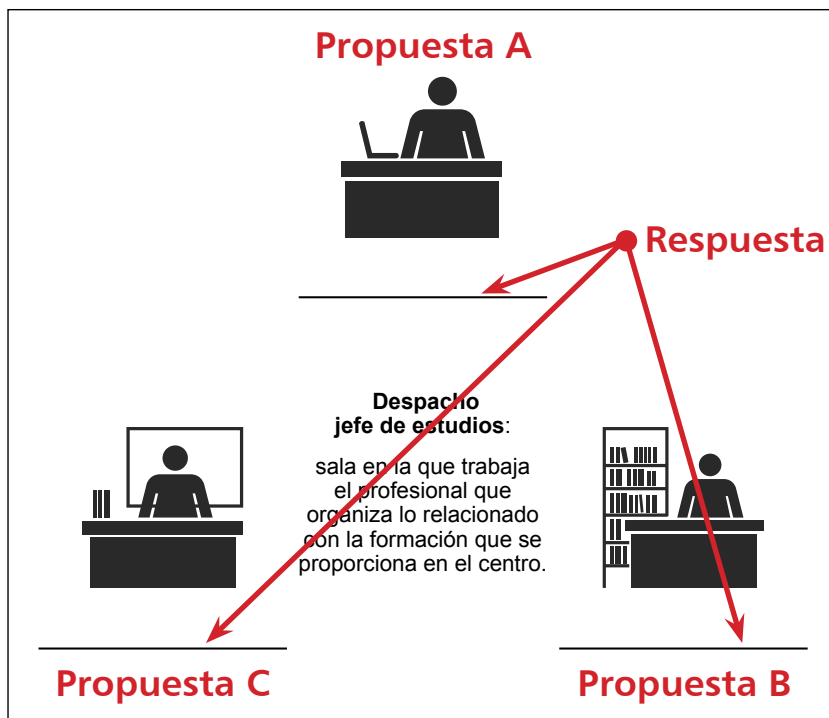

Esquema de organización de cada una de las páginas del cuadernillo de evaluación, con las tres propuestas y los campos para la respuesta

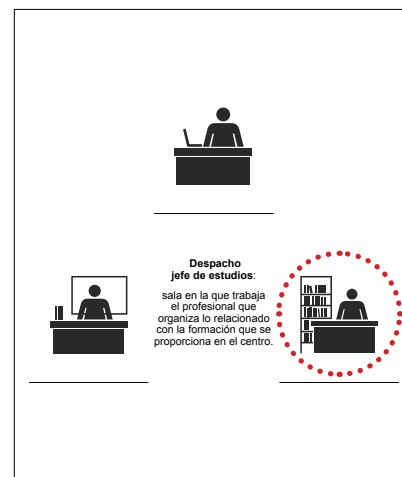

Muestra de página de cuadernillo de evaluación, con pictograma aceptado, después de la evaluación de Estimación de la Comprensibilidad

Los talleres de evaluación de la Parte 1 de la *Norma de la Estimación de la Comprensibilidad* se realizaron en los siguientes centros:

- IMSERSO:
 - Centro de Promoción de la Autonomía Personal (CPAP) de Bergondo
 - Centro de Referencia Estatal de Discapacidad y Dependencia San Andrés del Rabanedo
 - Centro de Atención a Personas con Discapacidad Física (CAMF) de Alcuéscar
- La asociación TADEGa
- El Centro de Atención al Refugiado (CAR) de Vallecas
- El Foro LideA (Liderazgo de Mayores)
- La Universidad Popular de Alcobendas (personas mayores de 65 años)

Se recibieron los resultados y se unificaron en una tabla de Excel. Se valoraron como aceptados los pictogramas que quedaron por encima del 51%.

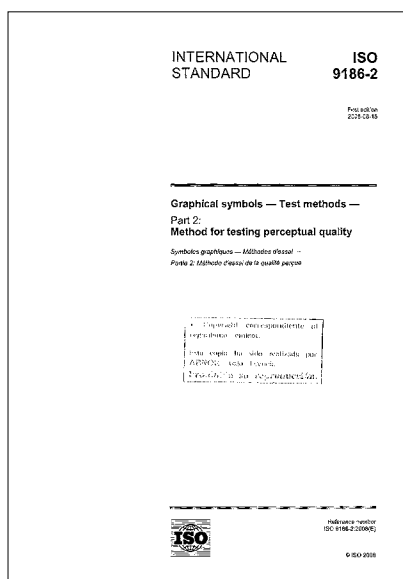

Se seleccionaron los pictogramas que habían pasado el 51% de aceptación, y en caso de haber más de uno, se incluyó el que había obtenido la puntuación máxima.

Posteriormente se extrajeron los pictogramas que pasaron el baremo estipulado y con la máxima puntuación, y se plastificaron en dos tamaños para proceder a la última evaluación: ISO 9186. Parte 2. Método de evaluación de la calidad perceptual.

Esta se llevó a cabo con:

- 1.— personas con discapacidad intelectual: Fundación Carlos Martín, Adisli, Amás.
- 2.— personas sin discapacidad, profesionales de Adisli, profesionales Fundación de Carlos Martín, profesionales de Amás, profesionales de Ceapat, profesionales de Dinamarca

Para terminar, se procedió a la rectificación de los pictogramas finales según las valoraciones relativas a la percepción. Pictogramas, disponibles en el Anexo 2, que se colgarán en el Blog creado al efecto para su uso gratuito.

CONCLUSIONES

Queremos mencionar otros proyectos internacionales que han servido de modelo para llevar a cabo este trabajo, dándoles el reconocimiento que merecen por haber establecido, hace ya muchos años, las bases de esta metodología de diseño de pictogramas de señalización. Destacamos el de «Hablamos Juntos: Improving Patient-Provider Communication for Latinos» [10] (desarrollo de una batería de pictogramas para el ámbito hospitalario en Estados Unidos), y los trabajos de investigación para el desarrollo de pictogramas de Eliana de Lemos Formiga, realizados en Brasil.

Centrándonos en las conclusiones extraídas de la tarea desarrollada, cabe destacar que el haber contado desde el inicio con la participación de un gran número de personas: extranjeras, mayores, con discapacidad intelectual, física y mental, profesionales de diferentes ámbitos, etc. nos ha permitido garantizar la implicación de los destinatarios finales en todo el proceso, para conseguir un resultado que nos beneficia a todos.

Así mismo, poner en valor el carácter creativo e innovador del trabajo, que nos ha facilitado enormemente la implicación de Centros y de profesionales de muchos ámbitos diferentes, tanto a nivel nacional como internacional.

Estamos convencidos de que el uso de estas pautas de diseño y de evaluación, permiten unificar y acotar el proceso de creación de pictogramas para la señalización, de manera que cualquier persona pueda identificar que estas imágenes pertenecen a este contexto, independientemente del lugar o país en el que se encuentren expuestas. Es necesario llegar a un consenso por parte de todas las partes interesadas, que nos permita avanzar en un mismo sentido

Es ya incuestionable el peso de la accesibilidad cognitiva como parte integral de la accesibilidad universal y se afianza el reto de diseñar espacios centrados en la persona y de establecer vías de comunicación funcionales entre la persona y el entorno que nos permitan movernos y desarrollar las actividades propias de la vida diaria de una forma comprensible, amigable y segura.

Nuestro trabajo pretende animar a otras entidades que se encuentren con las mismas necesidades de crear entornos más comprensibles a través de la señalización con pictogramas, a replicar esta metodología, y así ampliar la Biblioteca digital de pictogramas de señalización para su uso gratuito.

Por último, agradecer la labor desinteresada de tantos profesionales que han participado activamente desde el planteamiento del proyecto, y a lo largo de todas sus fases, así como el tiempo dedicado por todas las personas que han colaborado en el diseño y evaluación del material.

REFERENCIAS

Pautas de diseño de pictogramas para todas las personas Proyecto de biblioteca digital de recursos gráficos orientativos en accesibilidad cognitiva urbana (2011-2013).

http://accesibilidadcognitivaurbana.fundaciononce.es/docs/Manual_pictogramas.pdf

El diseño wayfinding

Dimas García Moreno

https://www.academia.edu/10783820/El_dise%C3%B1o_wayfinding

Hablamos Juntos: Improving Patient-Provider Communication for Latinos

<http://www.hablamosjuntos.org/>

Symbol Signs

<http://www.aiga.org/symbol-signs/>

Evaluación de comprensibilidad de símbolos gráficos a través de la ergonomía de la información. Eliana de Lemos Formiga.

http://www.dbd.puc-rio.br/pergamum/tesesabertas/0812133_2012_pretextual.pdf

ISO 9186-1 Preview

Graphical symbols — Test methods — Part 1: Method for testing comprehensibility

ISO 9186-2

Graphical symbols — Test methods — Part 2: Method for testing perceptual quality

<file:///C:/Users/05373307/Downloads/standard7398.pdf>

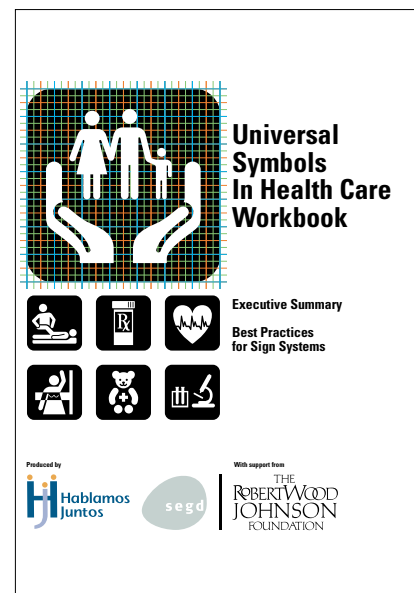
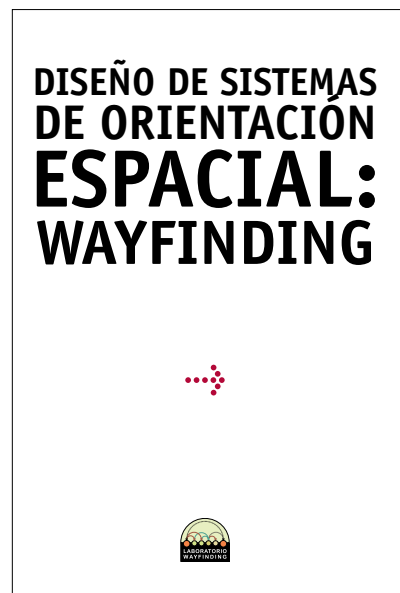
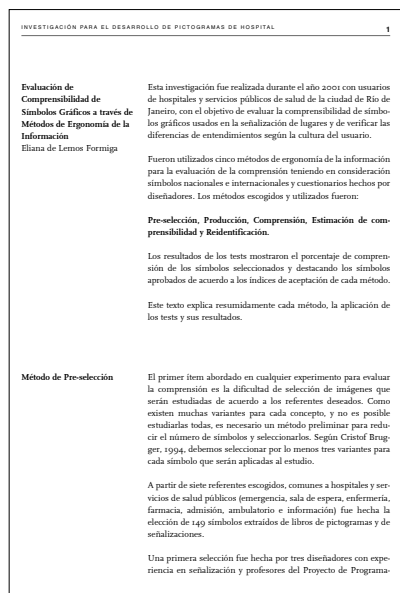

ANEXO 1

CAMF

LOCALIDAD: ALCUESCAR

GRUPO: PROFESIONALES

CAMF - ALCUESCAR

REFERENTE: AULA DE FORMACIÓN

GRUPO: PROFESIONALES

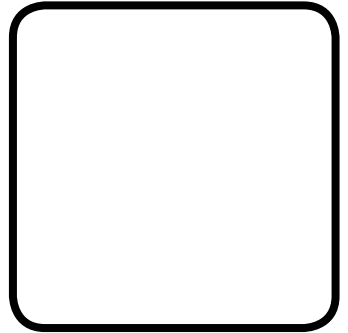
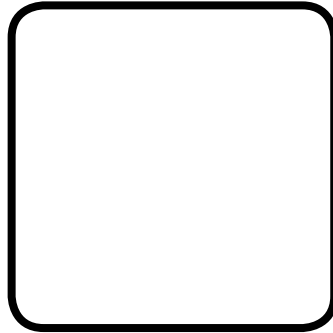

CONCLUSIONES:

CAMF - ALCUESCAR

REFERENTE: **COMEDOR RESIDENTES**

GRUPO: PROFESIONALES

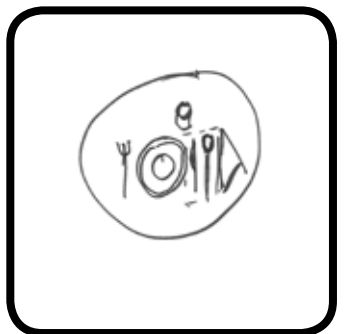
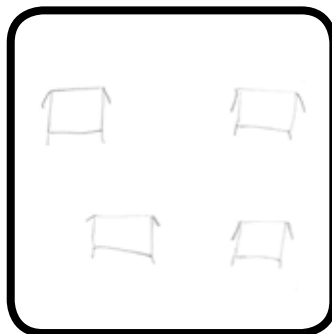
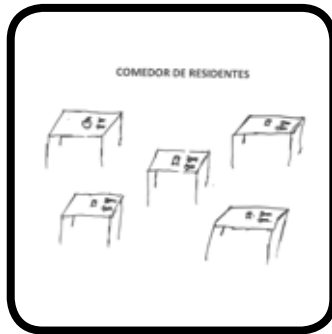

CONCLUSIONES:

CAMF - ALCUESCAR

REFERENTE: INFORMÁTICA	GRUPO: PROFESIONALES
-------------------------------	----------------------

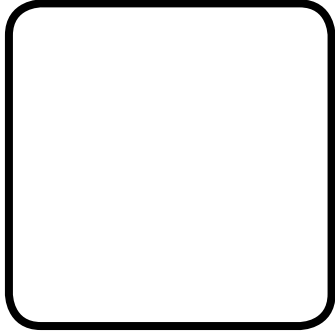
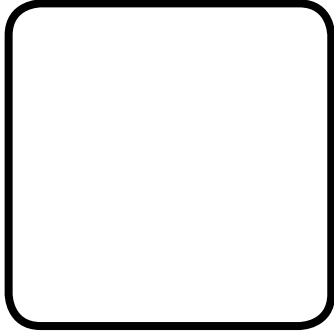
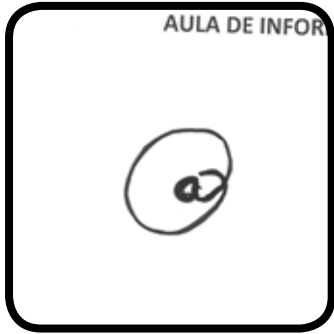

CONCLUSIONES:

CAMF - ALCUESCAR

REFERENTE: **ALMACÉN**

GRUPO: PROFESIONALES

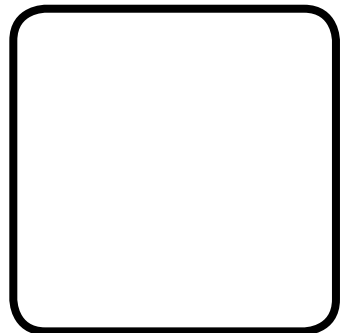
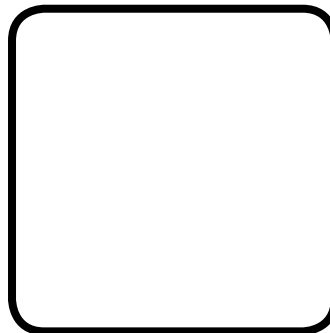
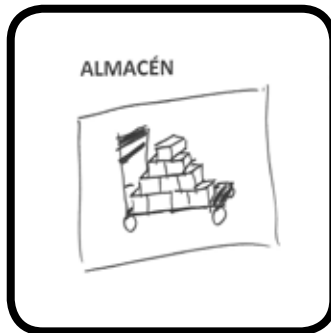
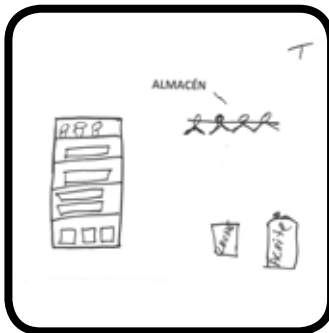
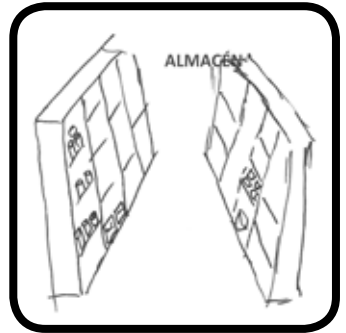
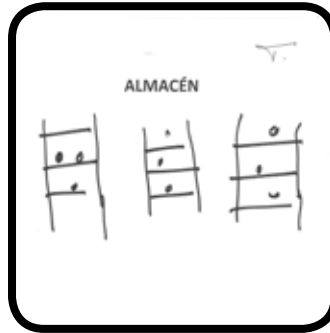
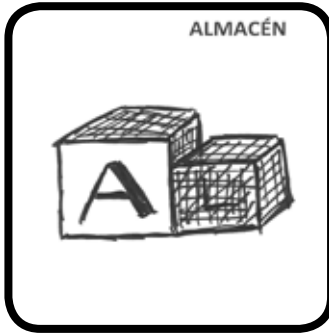

CONCLUSIONES:

CAMF - ALCUESCAR

REFERENTE: **DESPACHO ADMINISTRACIÓN**

GRUPO: PROFESIONALES

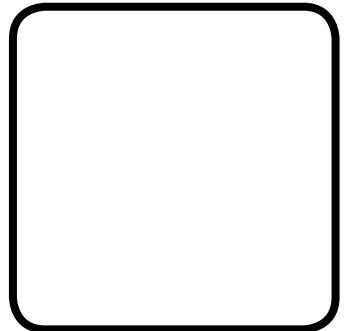

CONCLUSIONES:

CAMF - ALCUESCAR

REFERENTE: **DESPACHO ADMINISTRADOR**

GRUPO: PROFESIONALES

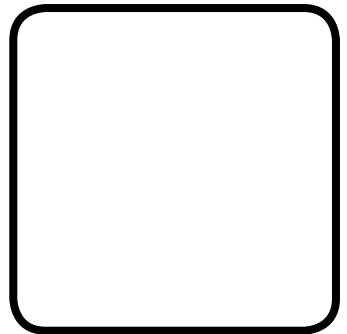
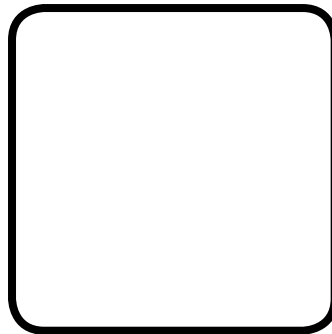
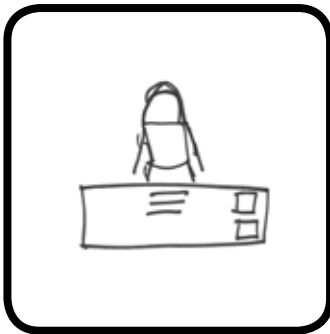
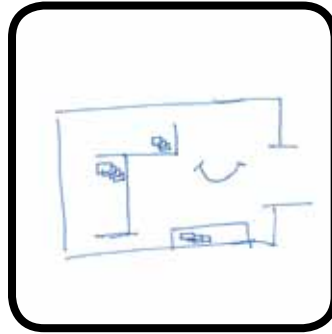

CONCLUSIONES:

CAMF - ALCUESCAR

REFERENTE: **RESPONSABLE ÁREA ASISTENCIAL**

GRUPO: PROFESIONALES

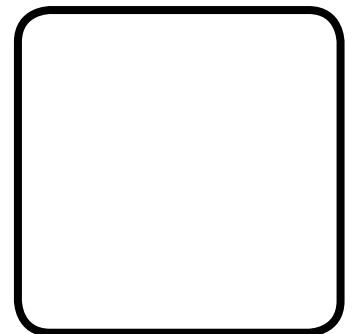
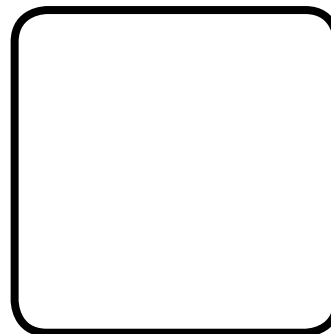
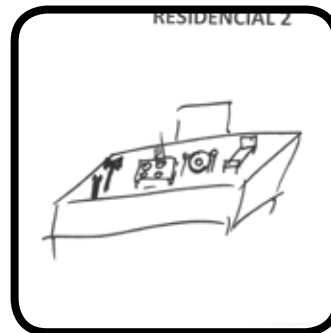
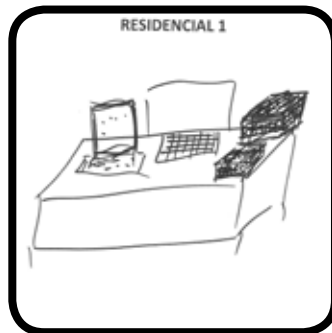

CONCLUSIONES:

CAMF - ALCUESCAR

REFERENTE: RESPONSABLE DE MANTENIMIENTO

GRUPO: PROFESIONALES

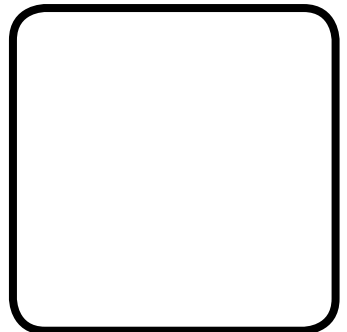
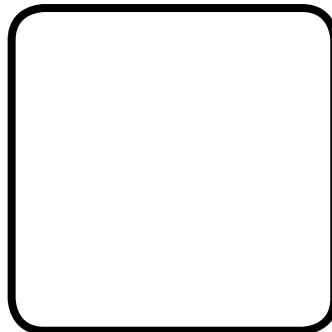
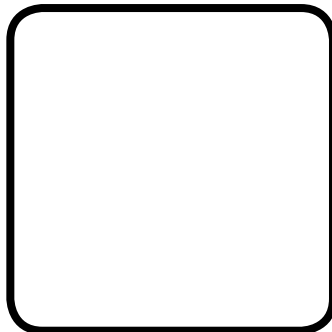
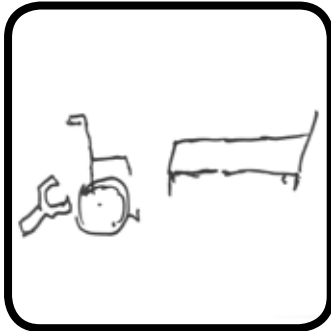

CONCLUSIONES:

CAMF - ALCUESCAR

REFERENTE: RESPONSABLE ÁREA DE GESTIÓN

GRUPO: PROFESIONALES

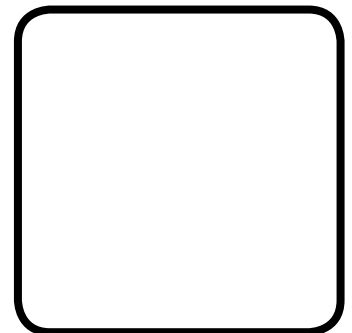
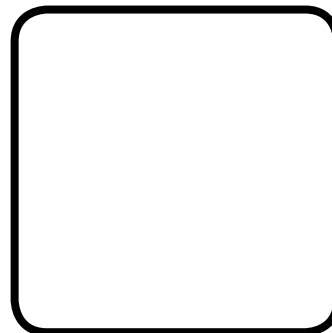
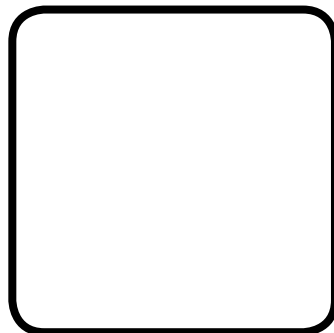
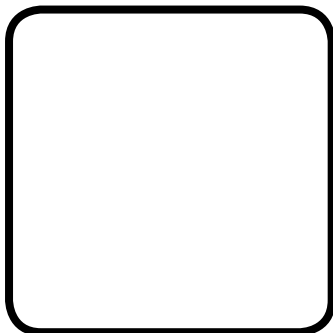
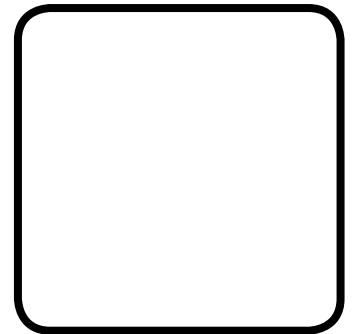
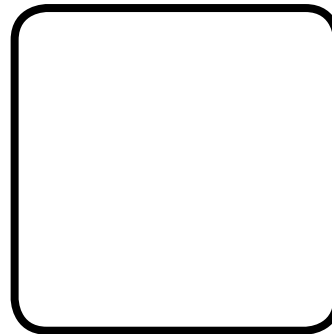
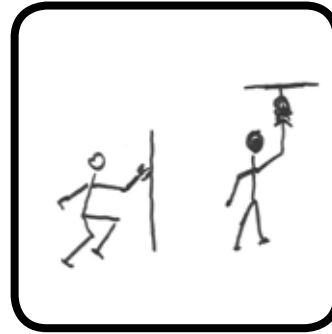

CONCLUSIONES:

CAMF - ALCUESCAR

REFERENTE: **DESPACHO GOBERNANTA**

GRUPO: PROFESIONALES

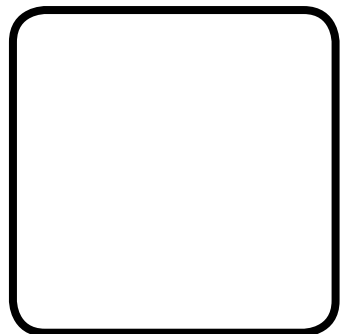
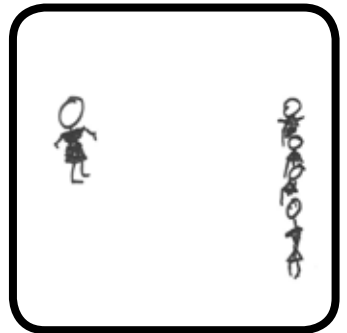

CONCLUSIONES:

CAMF - ALCUESCAR

REFERENTE: **DESPACHO PSICÓLOGO**

GRUPO: PROFESIONALES

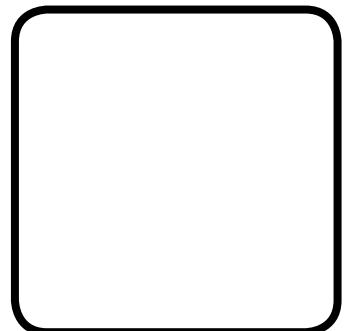
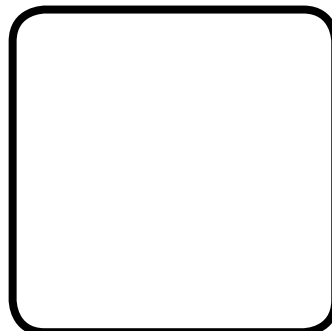
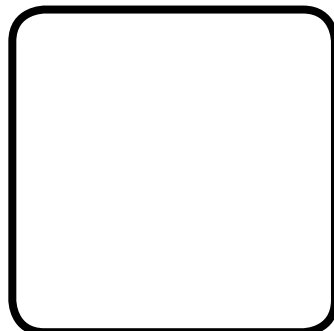
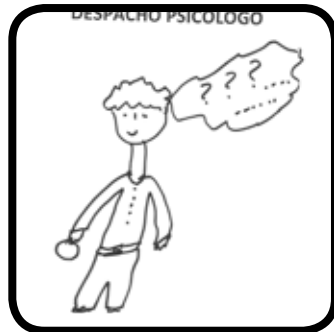
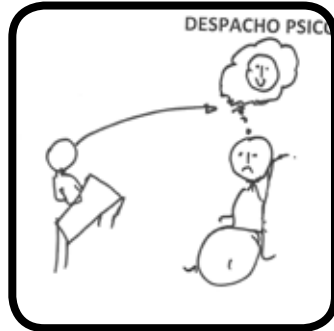

CONCLUSIONES:

CAMF - ALCUESCAR

REFERENTE: **RESPONSABLE DE RESIDENCIA**

GRUPO: PROFESIONALES

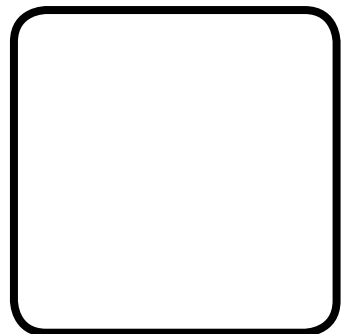
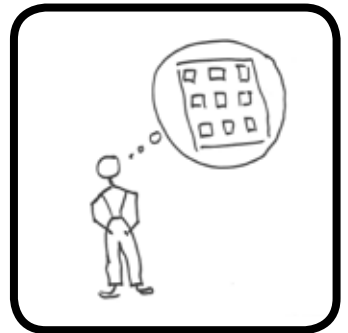

CONCLUSIONES:

CAMF - ALCUESCAR

REFERENTE: **DESPACHO TRABAJADOR SOCIAL**

GRUPO: **PROFESIONALES**

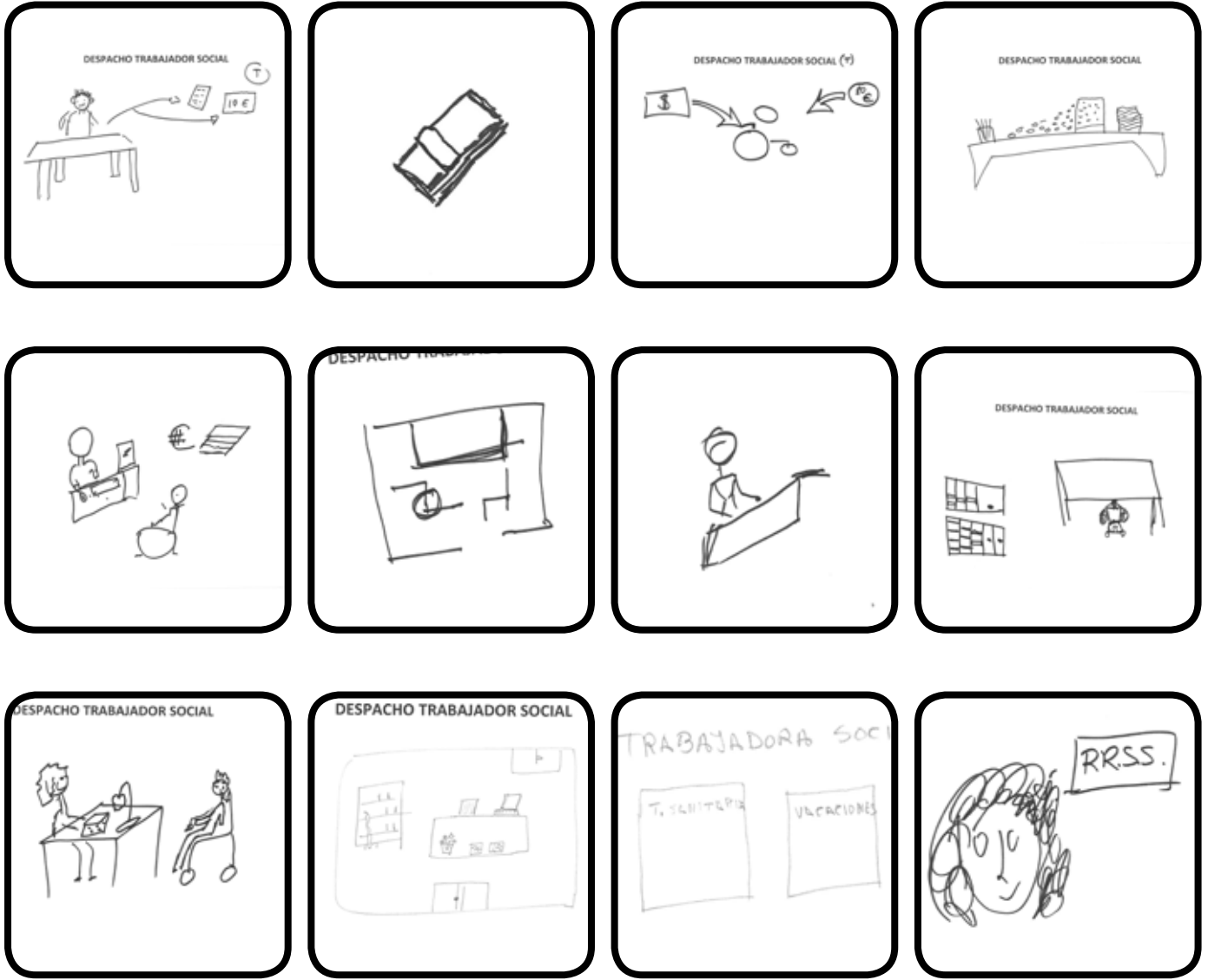

CONCLUSIONES:

CAMF - ALCUESCAR

REFERENTE: PABELLÓN MULTIUSOS	GRUPO: PROFESIONALES
--------------------------------------	----------------------

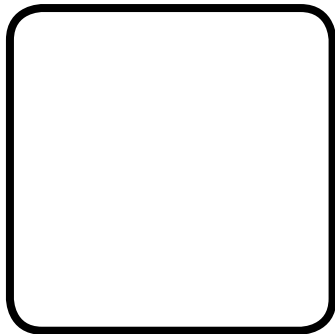
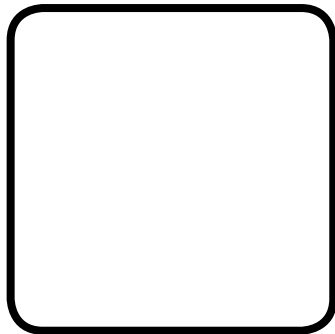
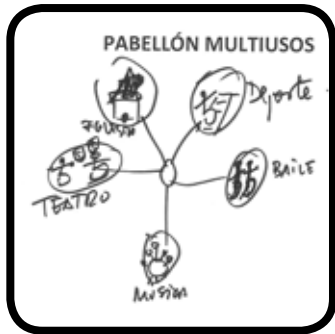
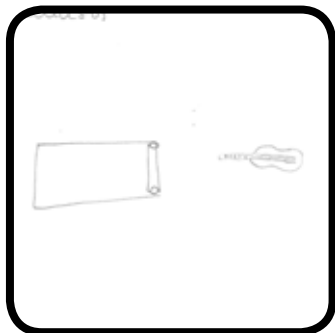
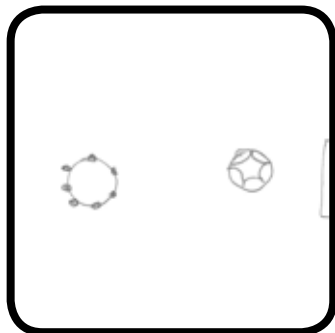
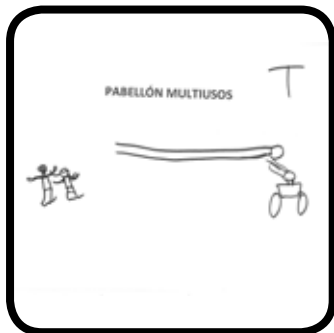
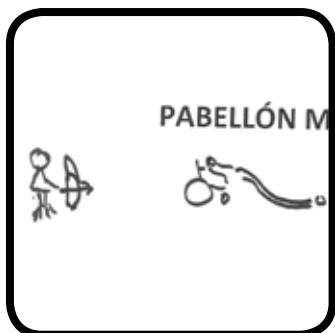
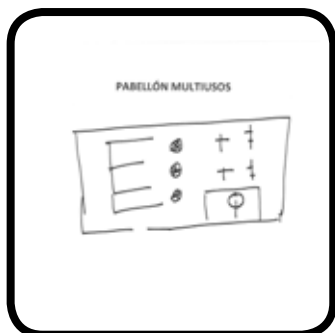
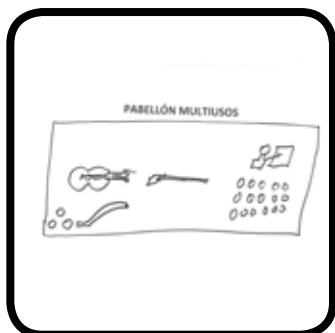
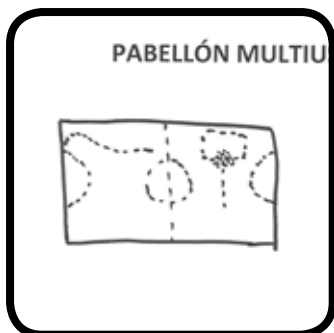

CONCLUSIONES:

CAMF - ALCUESCAR

REFERENTE: **SALA DE CURAS**

GRUPO: PROFESIONALES

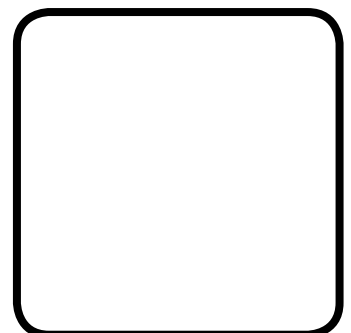
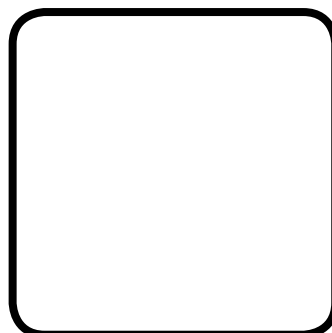
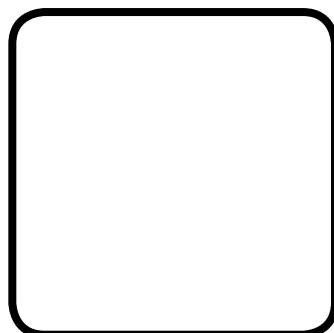
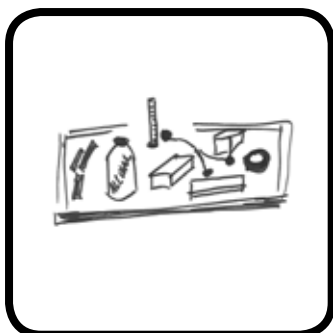
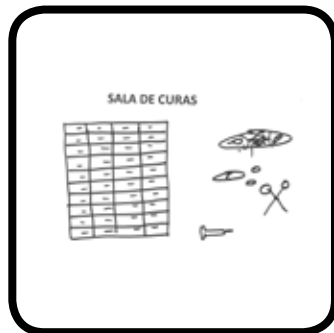

CONCLUSIONES:

CAMF - ALCUESCAR

REFERENTE: SALA DE ENCUADERNACIÓN

GRUPO: PROFESIONALES

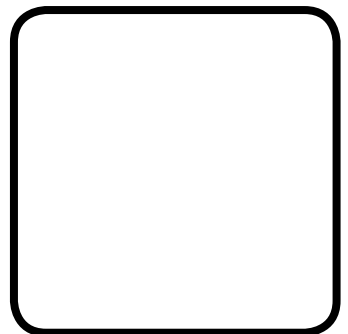
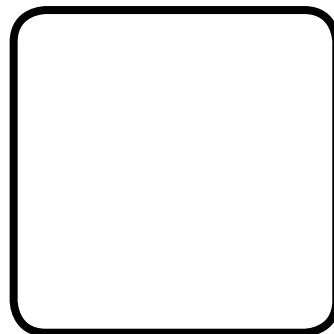
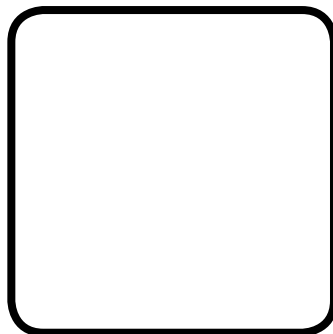
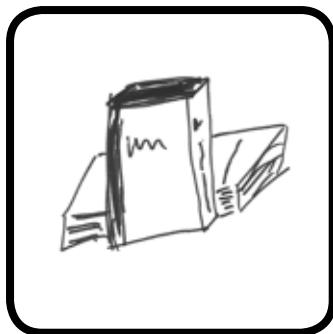
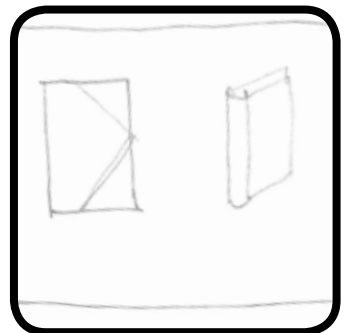
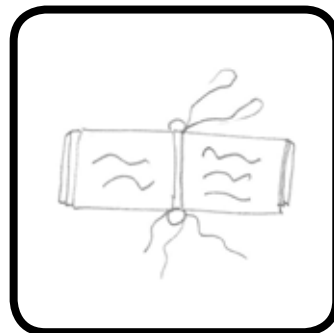
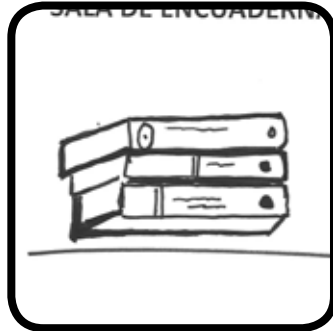

CONCLUSIONES:

CAMF - ALCUESCAR

REFERENTE: SALA DE ENFERMERÍA

GRUPO: PROFESIONALES

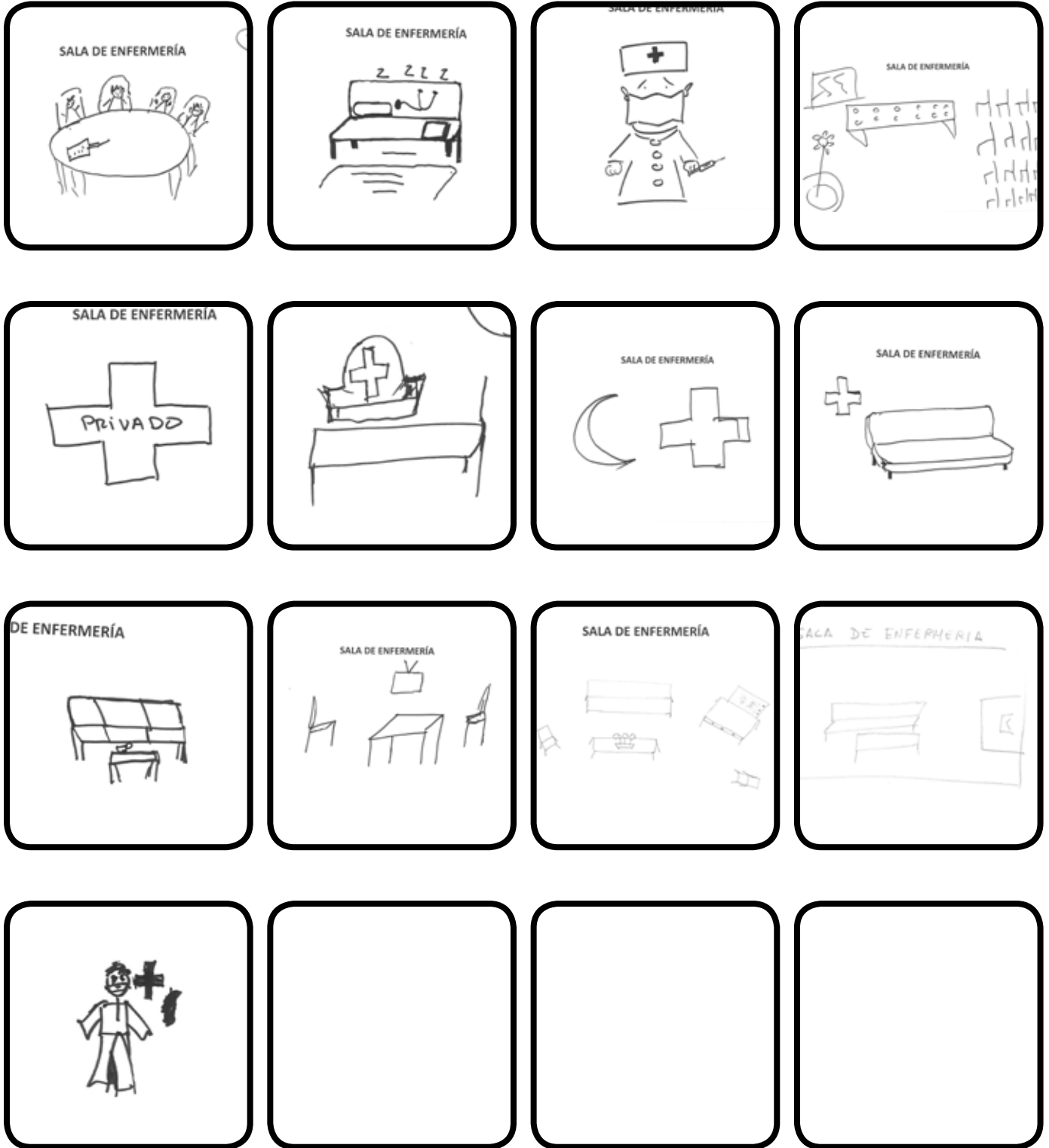

CONCLUSIONES:

CAMF - ALCUESCAR

REFERENTE: **SALA DE FISIOTERAPIA**

GRUPO: PROFESIONALES

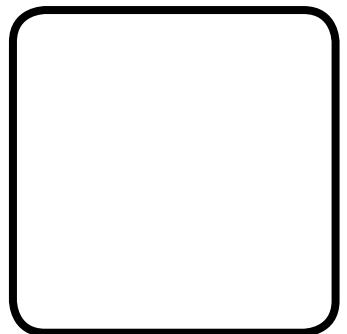
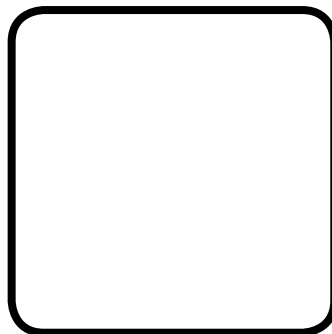
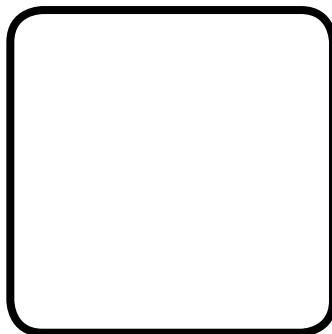
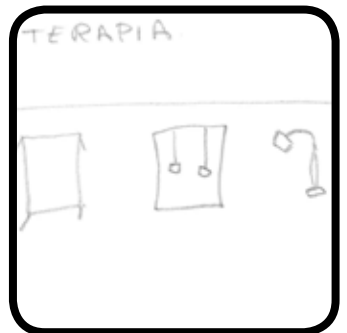
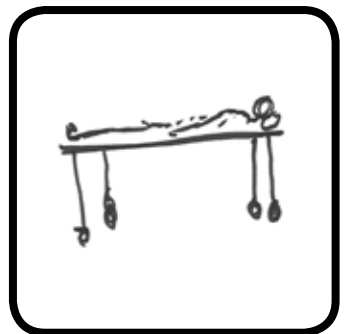
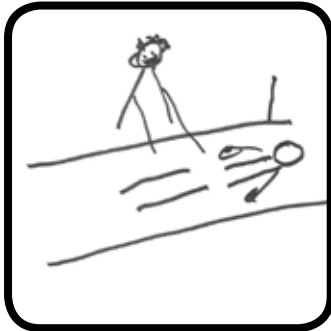

CONCLUSIONES:

CAMF - ALCUESCAR

REFERENTE: **SALA DE LOGOPEDIA**

GRUPO: PROFESIONALES

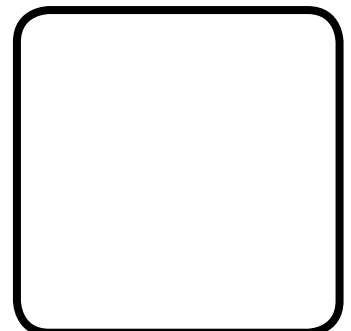
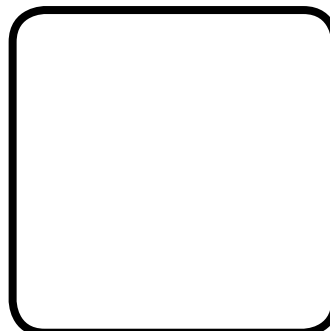
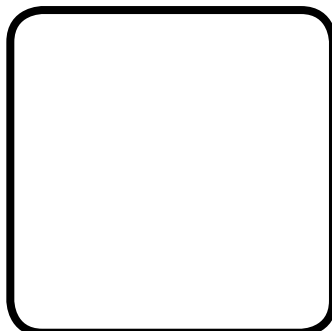
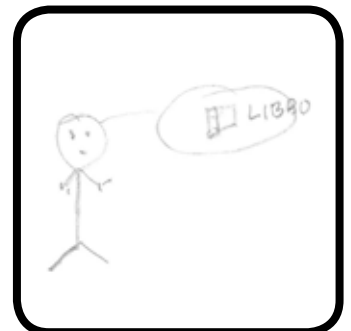
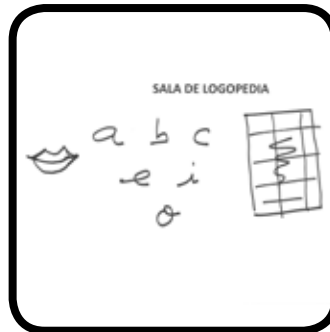
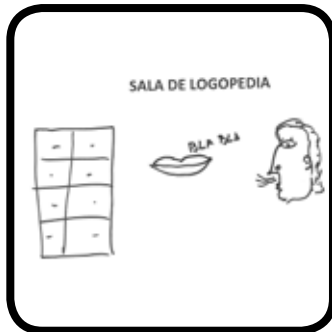

CONCLUSIONES:

CAMF - ALCUESCAR

REFERENTE: SALA DE TÉCNICAS DE ENFERMERÍA

GRUPO: PROFESIONALES

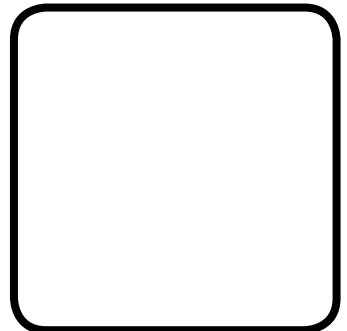
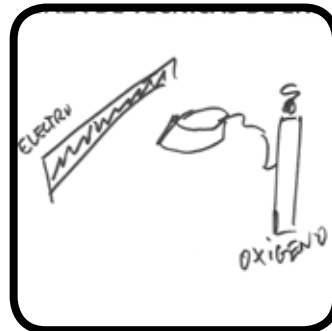
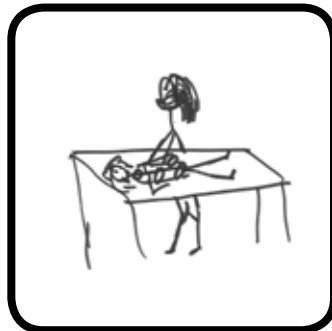
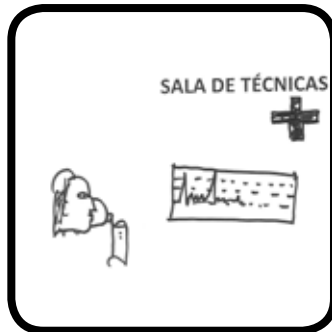

CONCLUSIONES:

CAMF - ALCUESCAR

REFERENTE: SALA DE TERAPIA OCUPACIONAL

GRUPO: PROFESIONALES

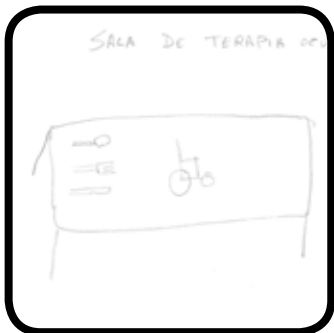
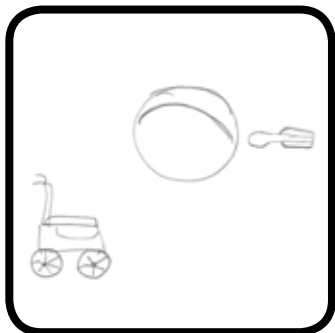
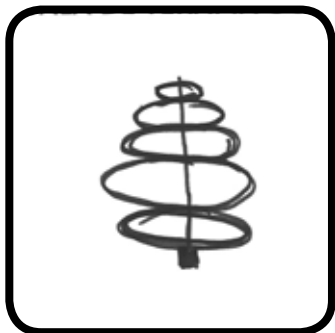

CONCLUSIONES:

CAMF - ALCUESCAR

REFERENTE: TALLER OCUPACIONAL

GRUPO: PROFESIONALES

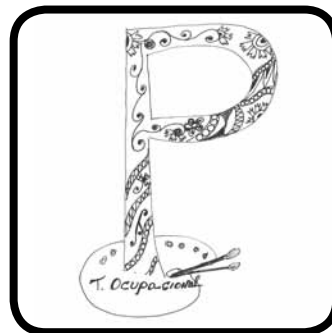
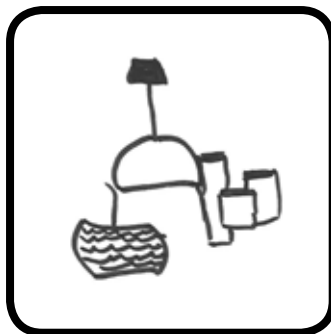

CONCLUSIONES:

CAMF

LOCALIDAD: ALCUESCAR

GRUPO: USUARIOS

CAMF - ALCUESCAR

REFERENTE: AULA DE FORMACIÓN	GRUPO: USUARIOS
------------------------------	-----------------

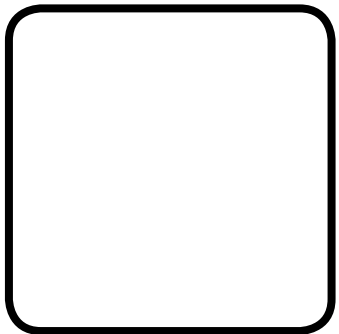
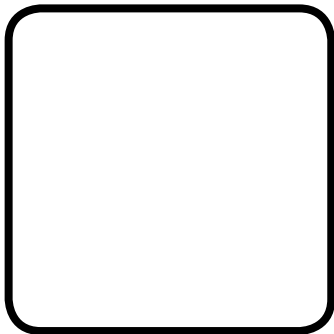
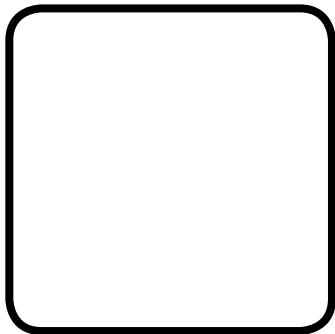
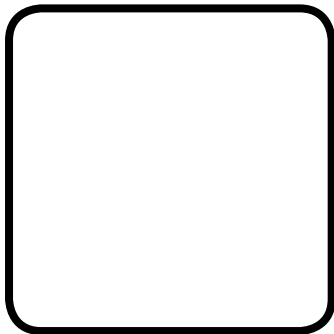
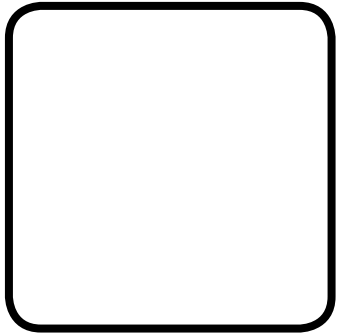
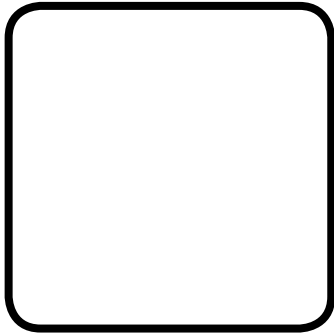
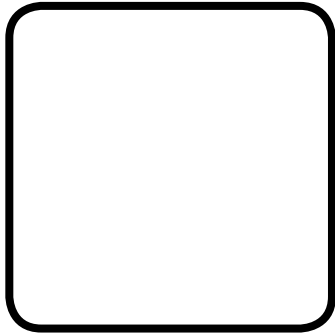
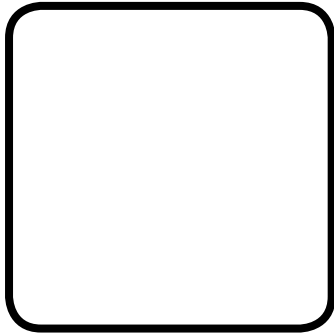
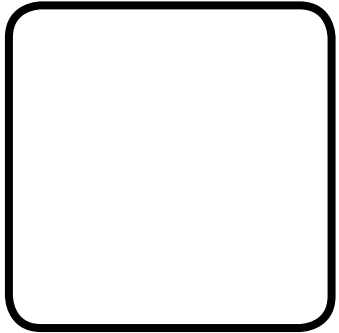
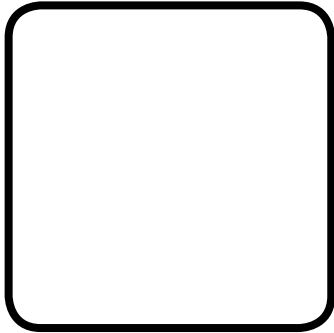
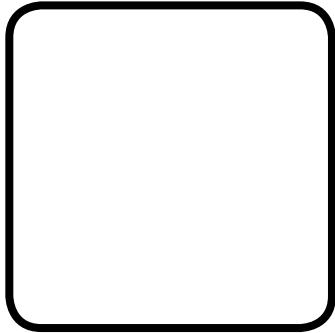

CONCLUSIONES:

CAMF - ALCUESCAR

REFERENTE: **COMEDOR RESIDENTES**

GRUPO: **USUARIOS**

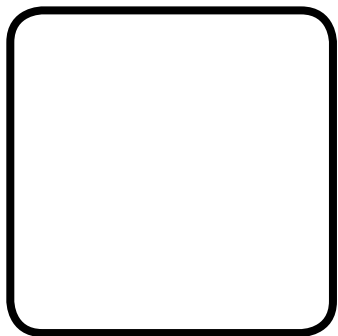
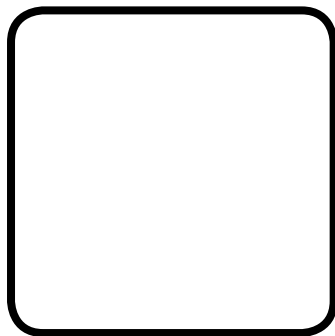
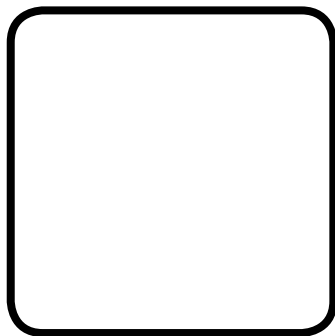
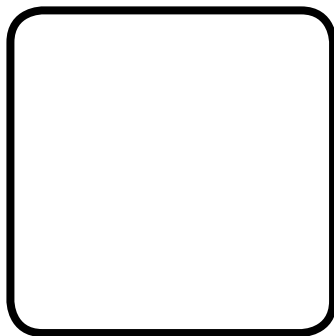
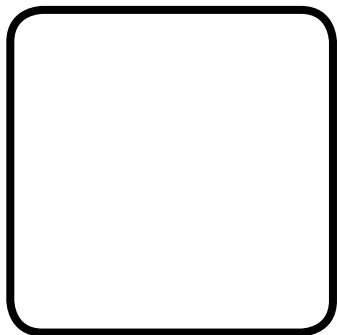
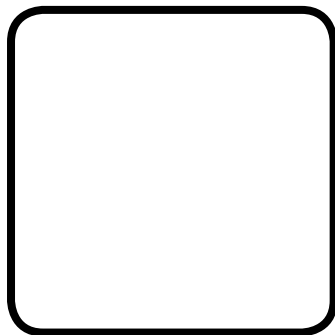
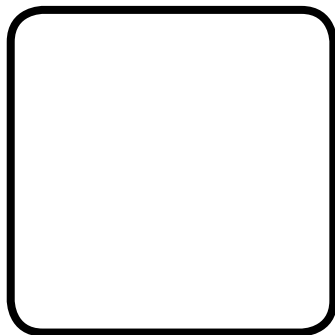
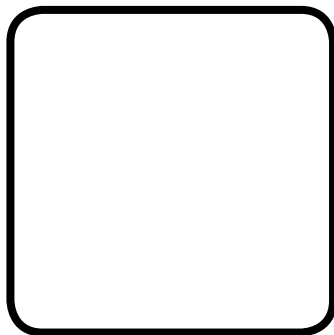
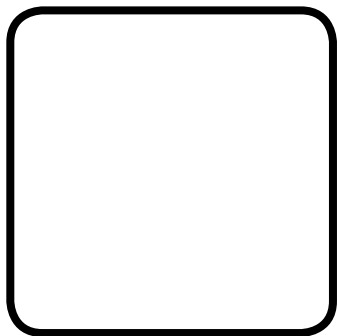
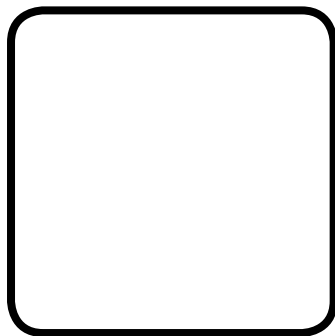
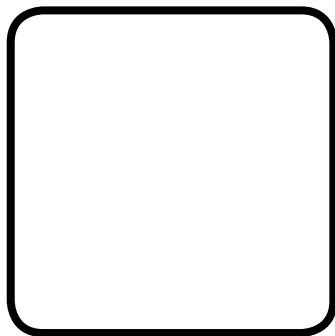
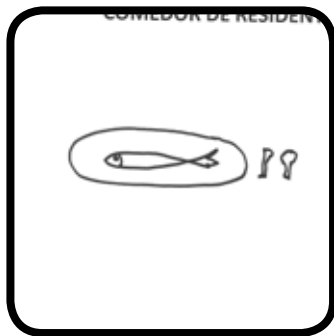
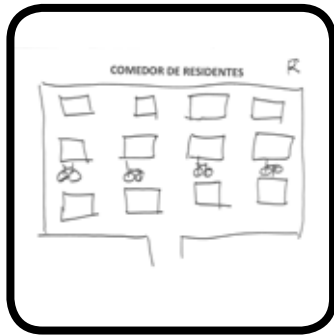

CONCLUSIONES:

CAMF - ALCUESCAR

REFERENTE: **INFORMÁTICA**

GRUPO: **USUARIOS**

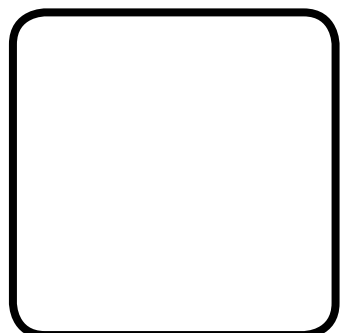
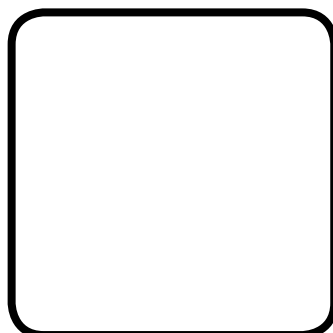
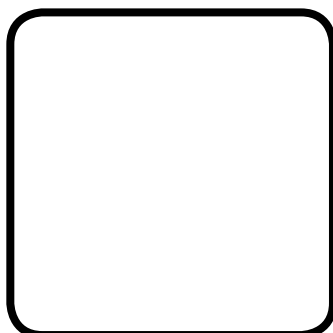
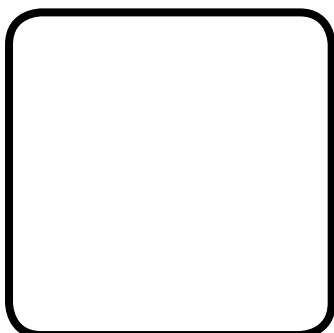
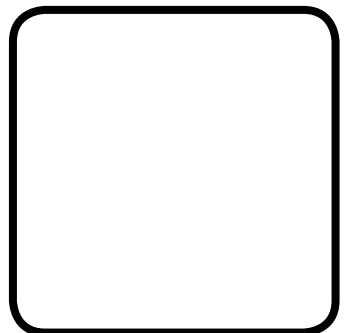
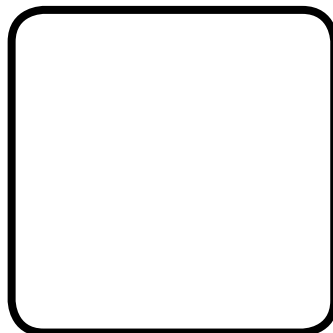
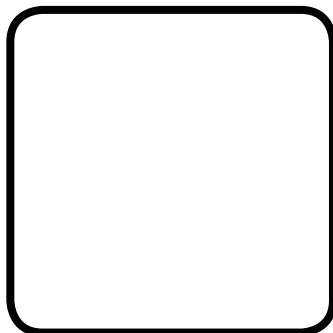
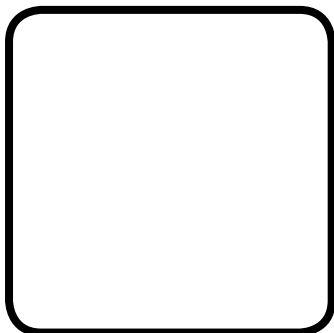
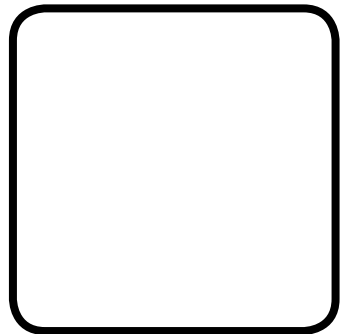
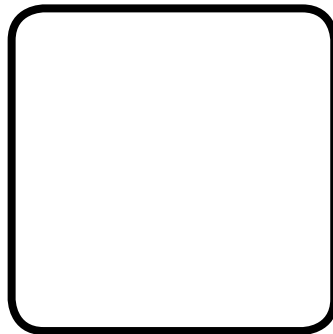
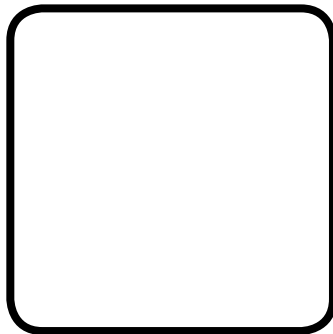

CONCLUSIONES:

CAMF - ALCUESCAR

REFERENTE: **ALMACÉN**

GRUPO: **USUARIOS**

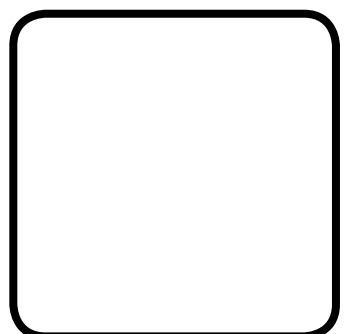
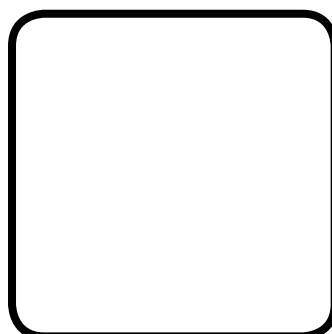
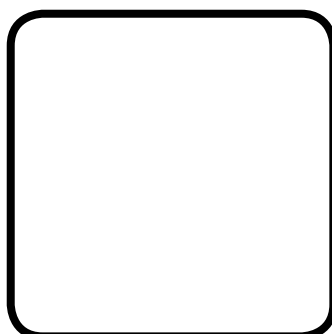
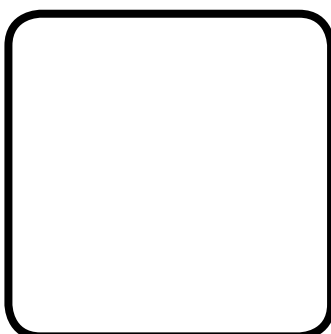
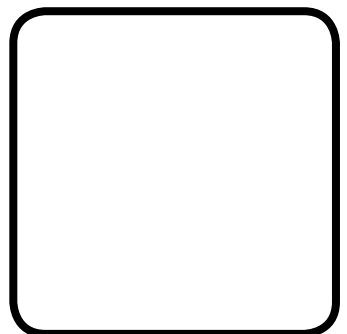
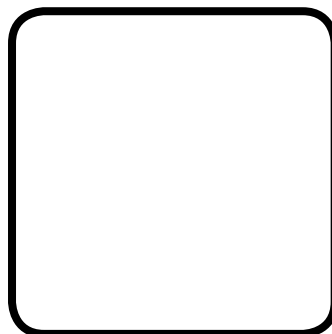
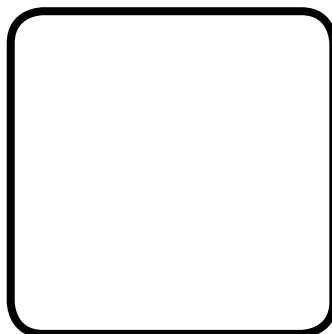
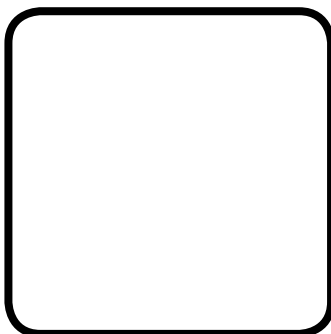
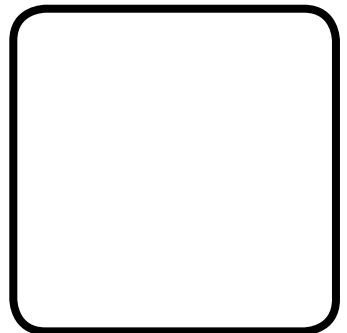
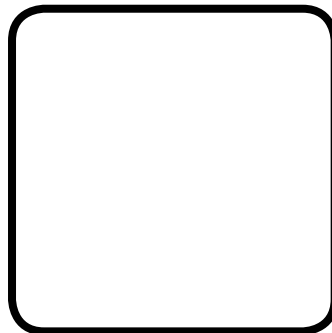
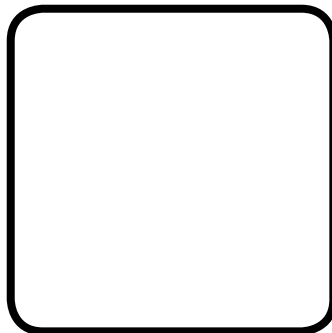
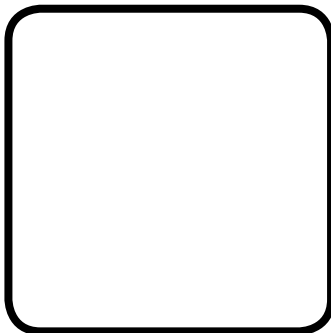
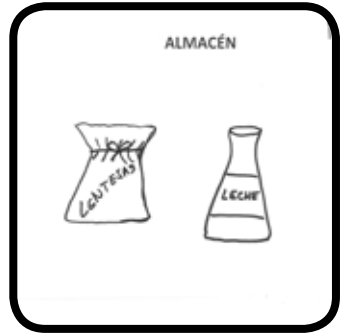
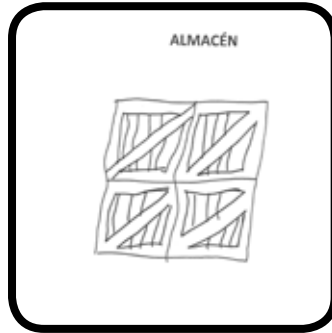
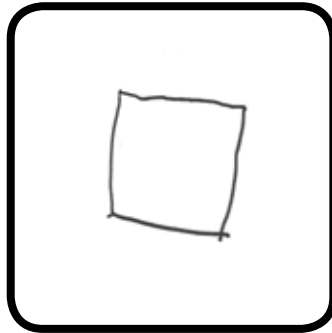
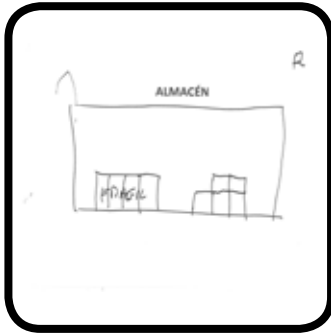





CONCLUSIONES:

CAMF - ALCUESCAR

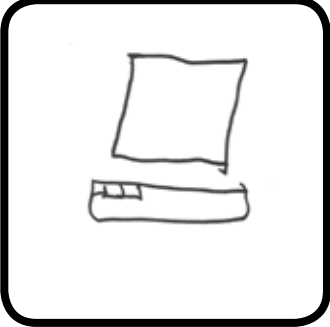
REFERENTE: **DESPACHO ADMINISTRACIÓN**

GRUPO: **USUARIOS**

			
			

CONCLUSIONES:

CAMF - ALCUESCAR

REFERENTE: **DESPACHO ADMINISTRADOR**

GRUPO: **USUARIOS**

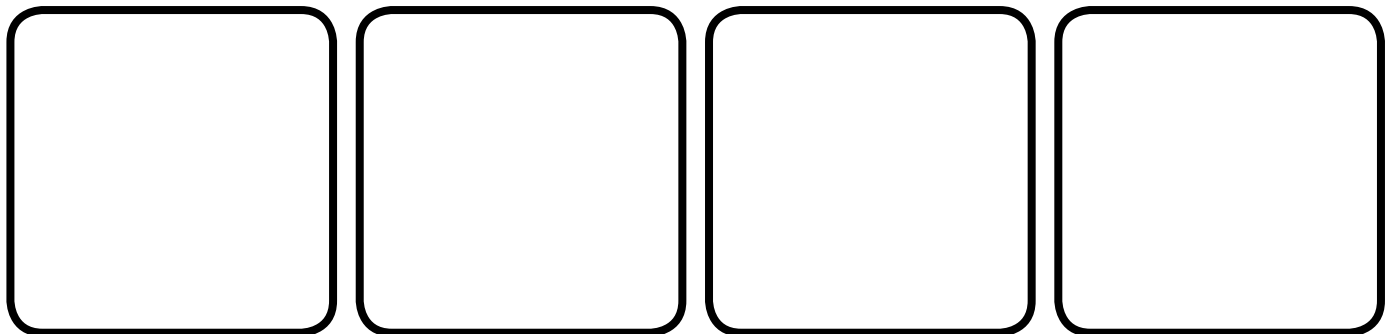
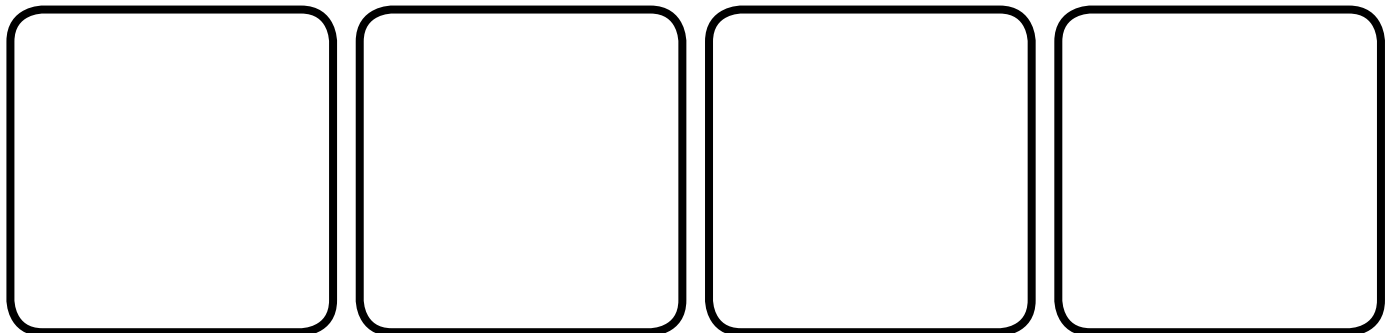
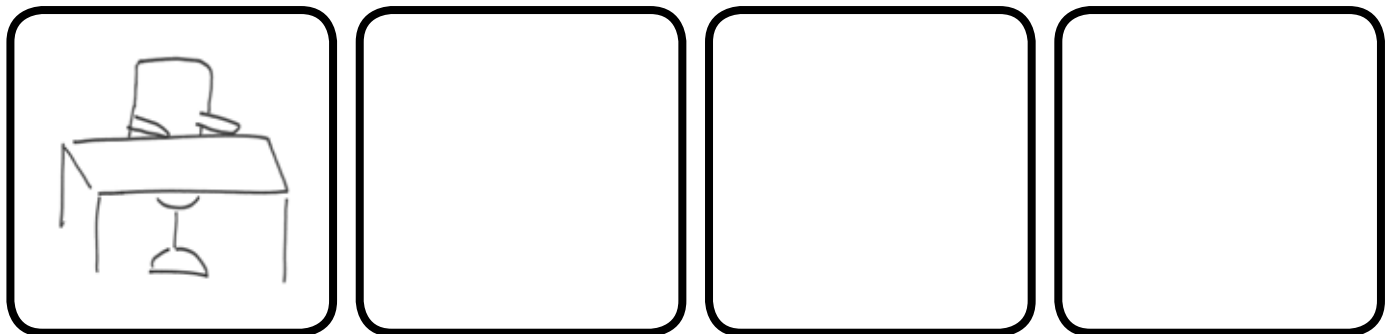
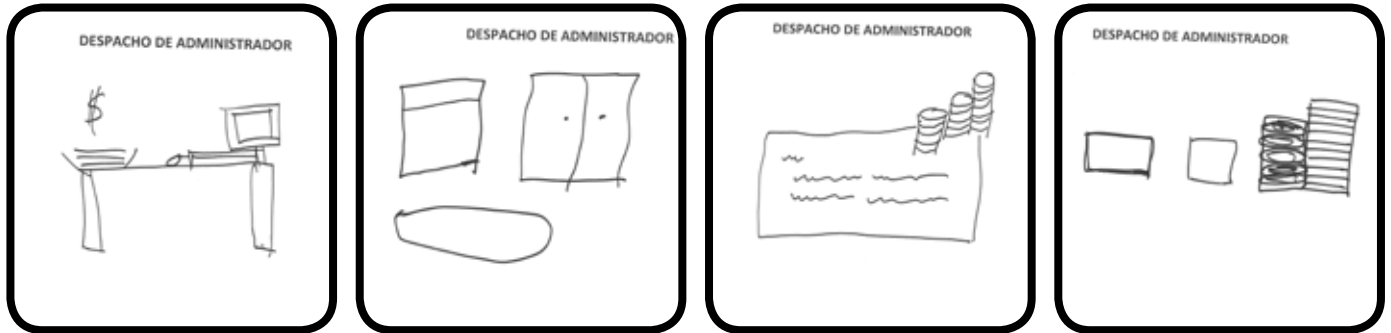

CONCLUSIONES:

CAMF - ALCUESCAR

REFERENTE: **RESPONSABLE ÁREA ASISTENCIAL**

GRUPO: **USUARIOS**

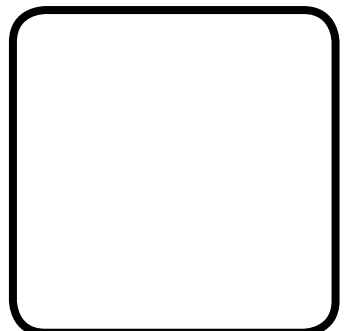
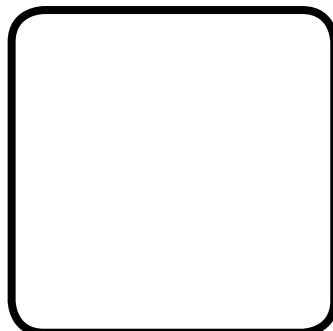
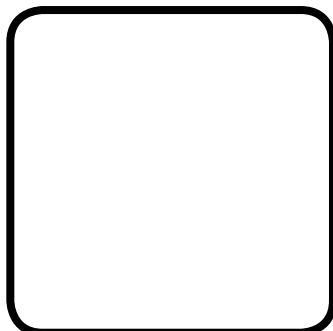
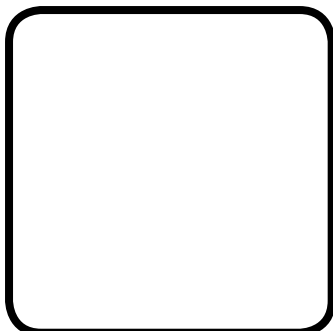
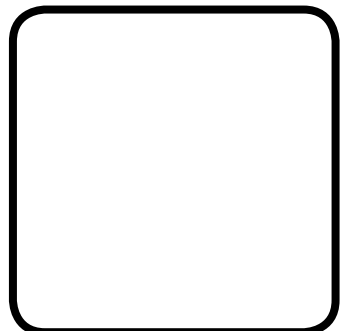
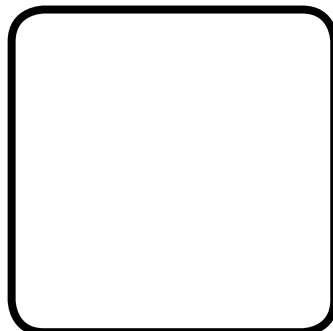
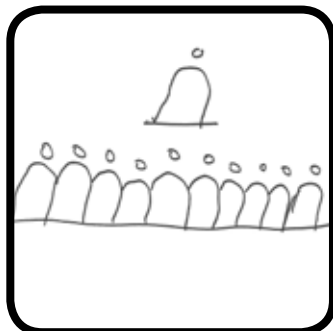
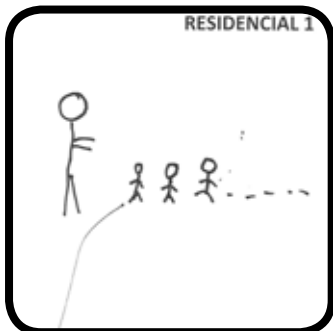
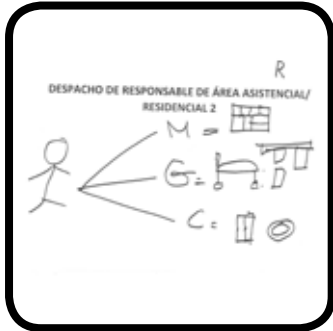

CONCLUSIONES:

CAMF - ALCUESCAR

REFERENTE: RESPONSABLE DE MANTENIMIENTO

GRUPO: USUARIOS

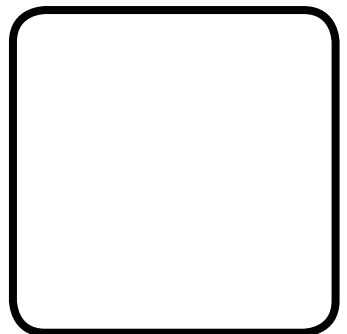
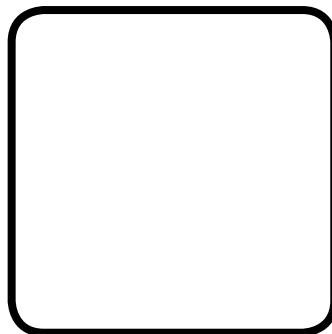
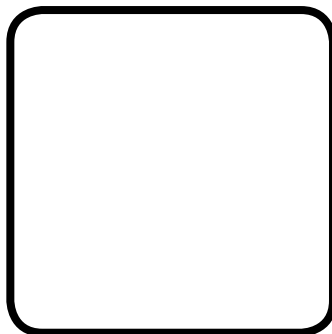
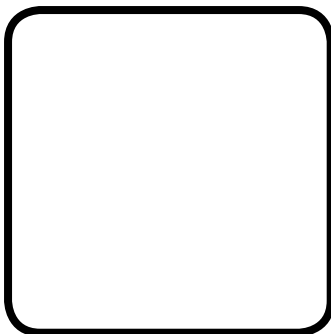
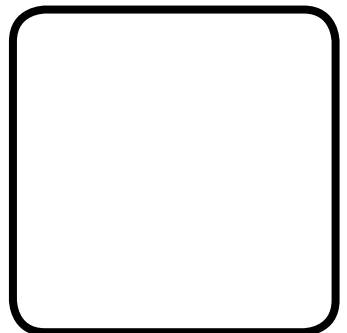
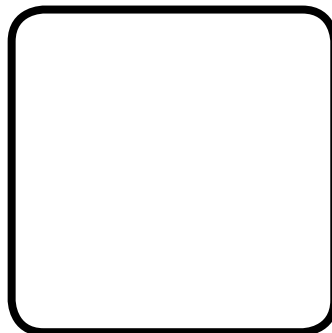
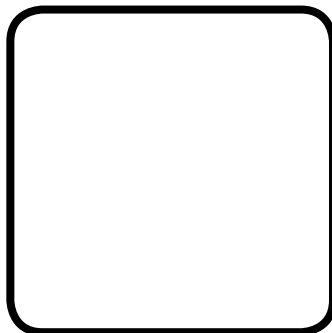
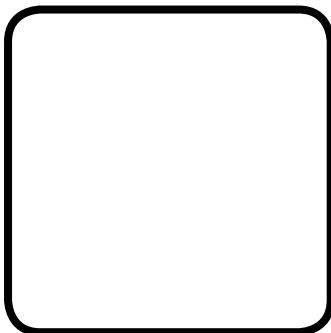
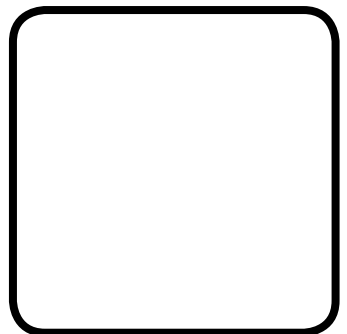
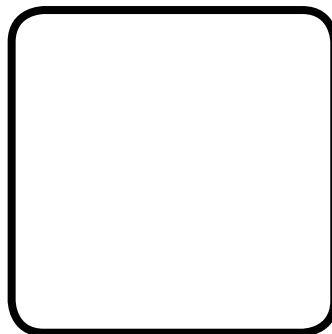
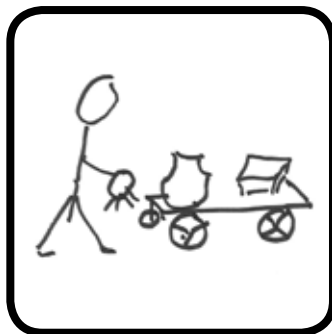

CONCLUSIONES:

CAMF - ALCUESCAR

REFERENTE: RESPONSABLE ÁREA DE GESTIÓN

GRUPO: USUARIOS

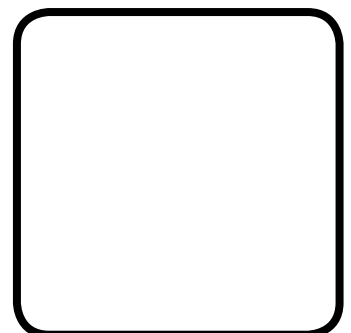
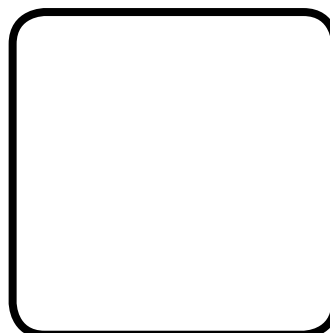
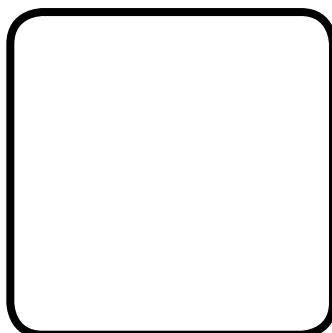
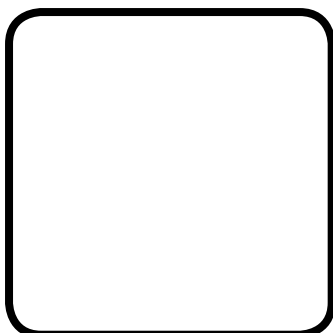
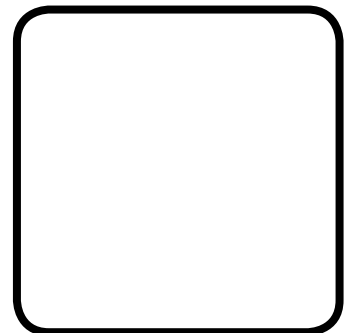
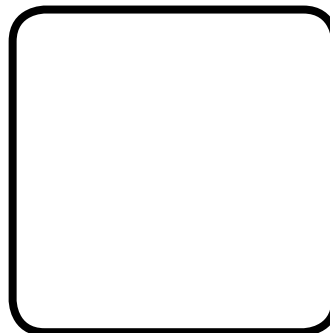
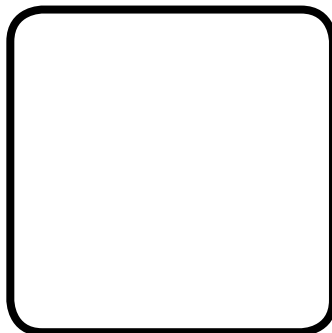
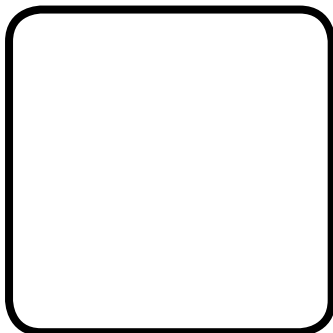
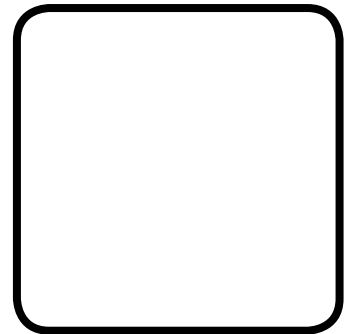
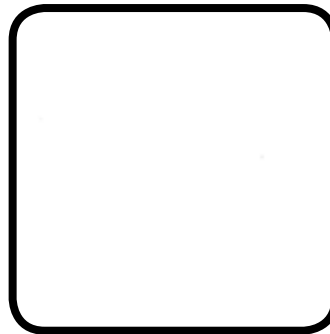
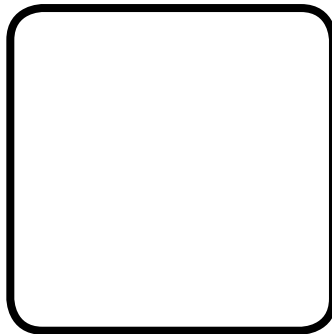
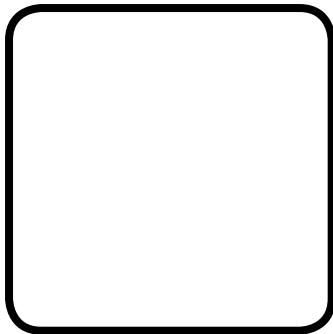

CONCLUSIONES:

CAMF - ALCUESCAR

REFERENTE: **DESPACHO GOBERNANTA**

GRUPO: **USUARIOS**

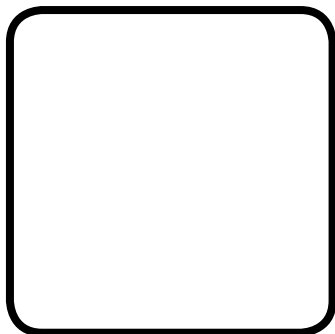
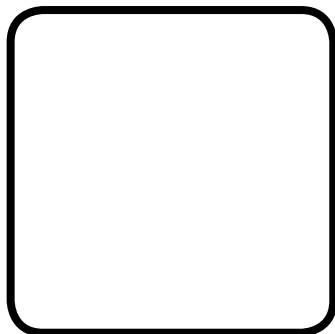
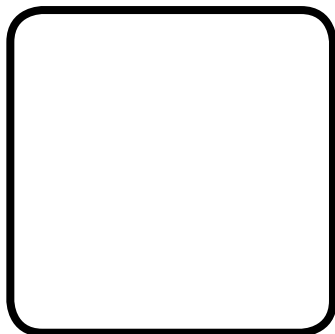
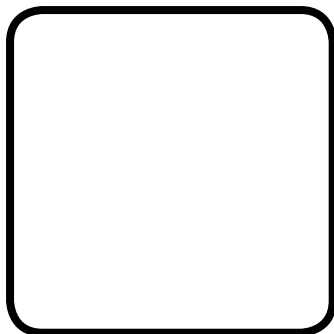
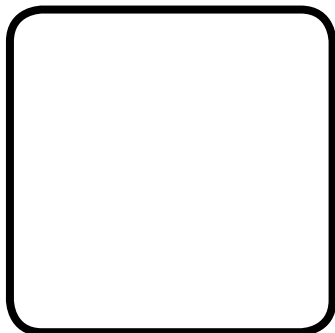
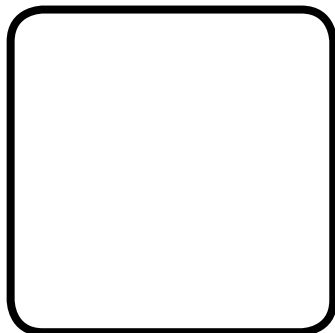
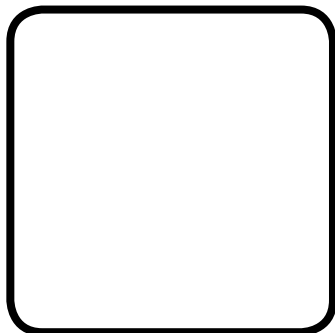
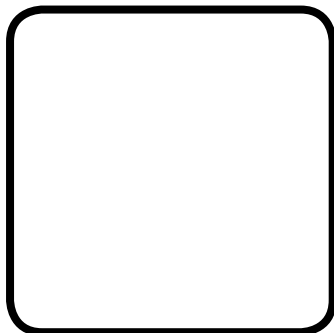
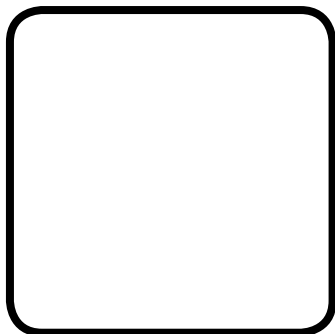
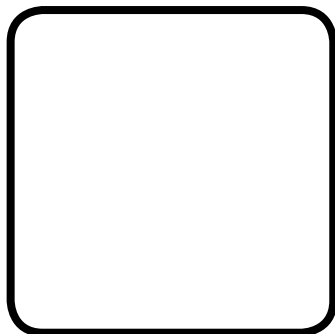
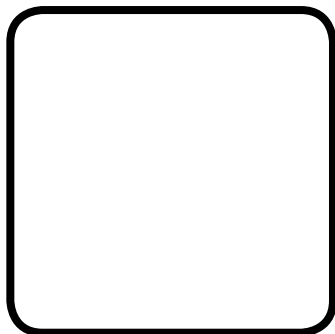
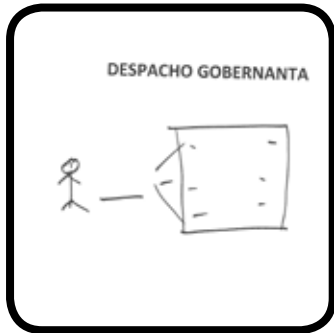

CONCLUSIONES:

CAMF - ALCUESCAR

REFERENTE: DESPACHO PSICÓLOGO	GRUPO: USUARIOS
--------------------------------------	-----------------

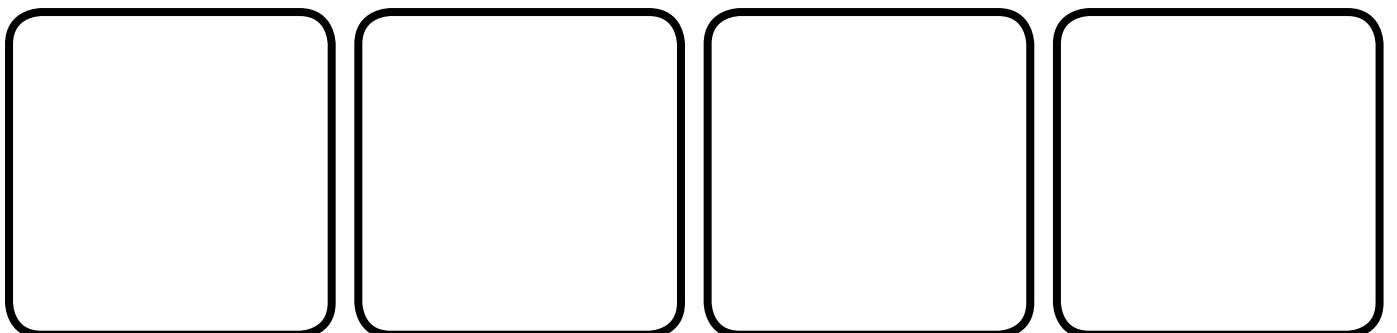
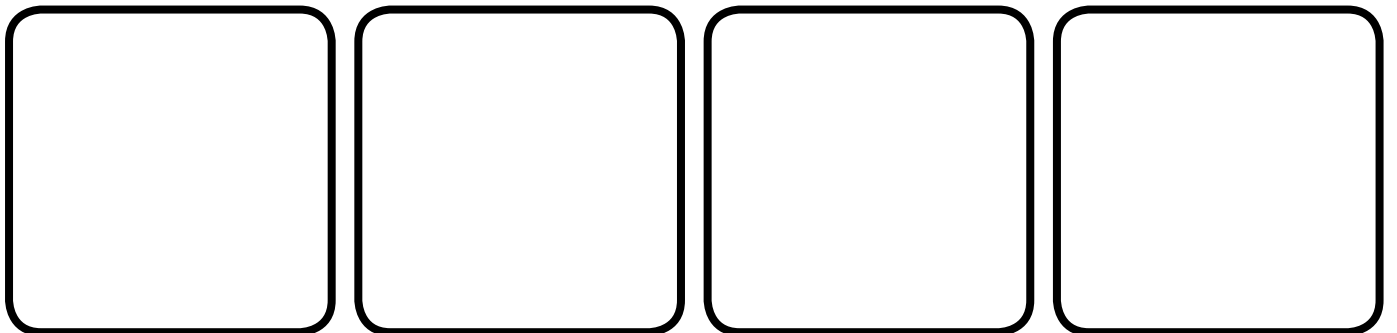
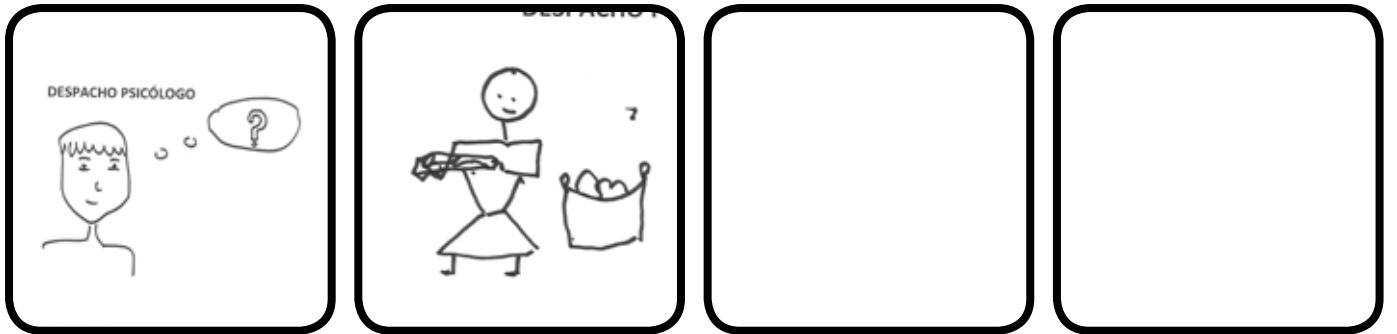
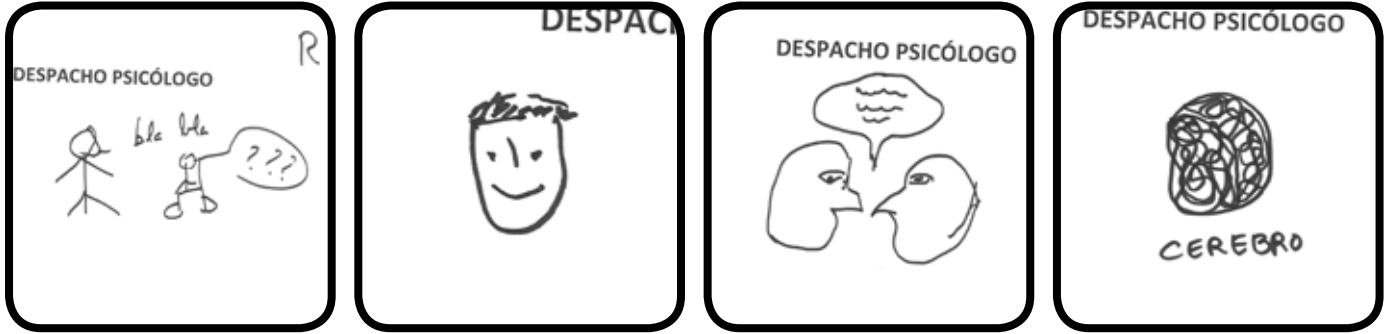

CONCLUSIONES:

CAMF - ALCUESCAR

REFERENTE: **RESPONSABLE DE RESIDENCIA**

GRUPO: **USUARIOS**

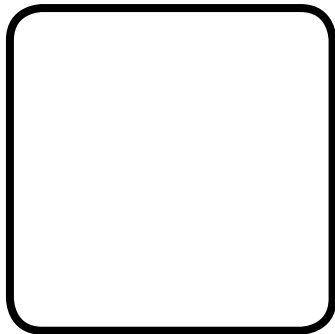
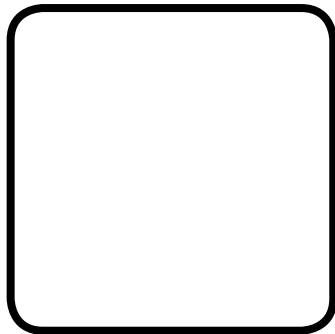
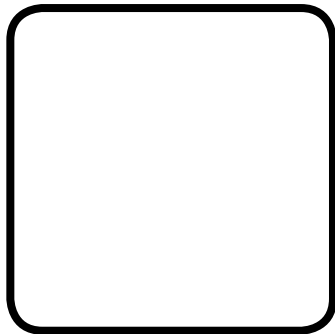
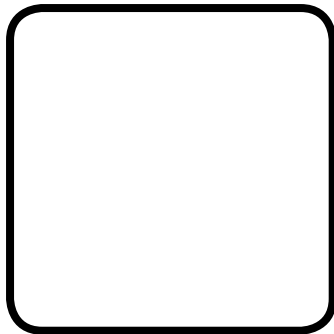
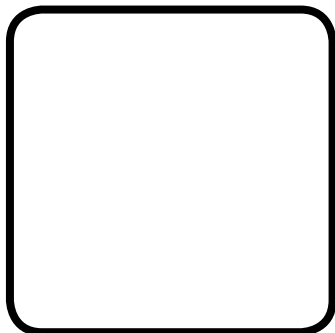
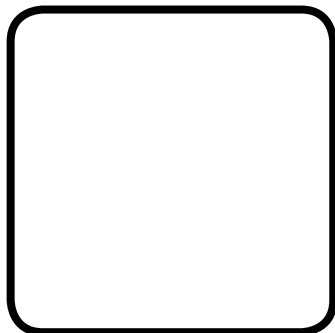
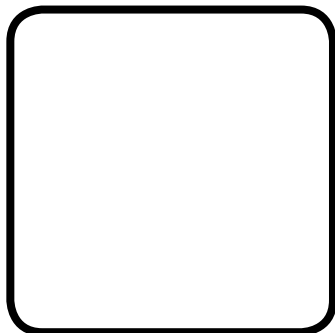
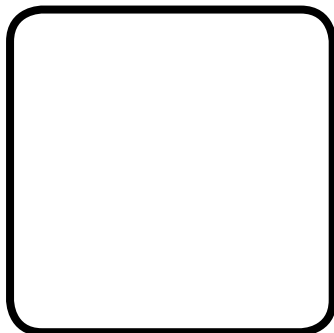
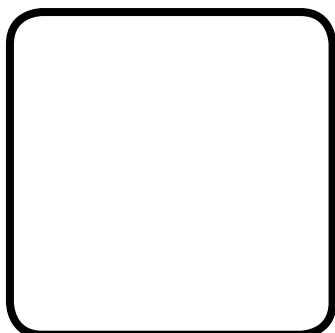
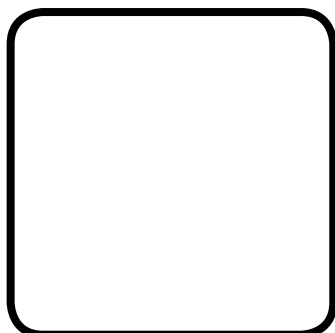
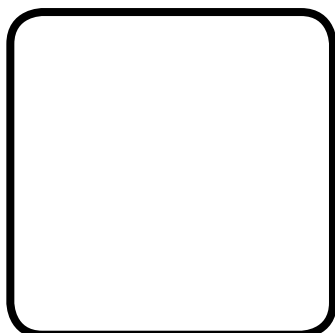

CONCLUSIONES:

CAMF - ALCUESCAR

REFERENTE: **DESPACHO TRABAJADOR SOCIAL**

GRUPO: **USUARIOS**

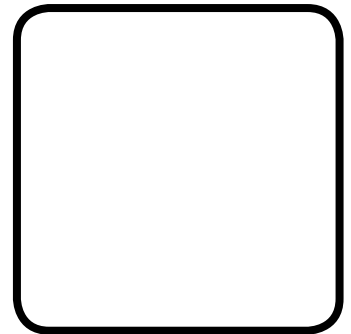
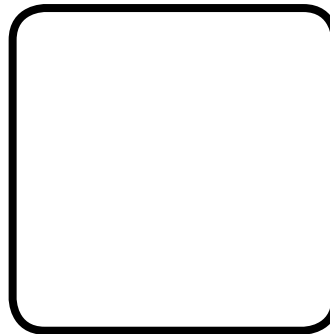
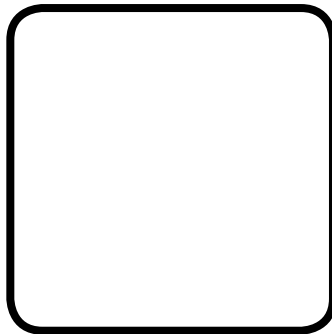
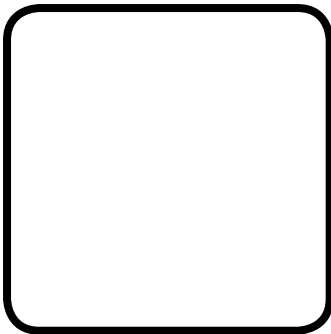
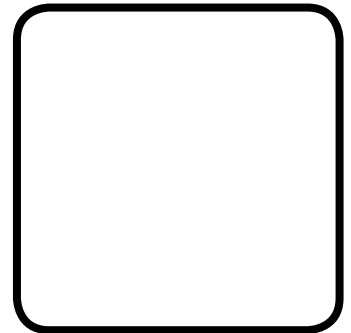
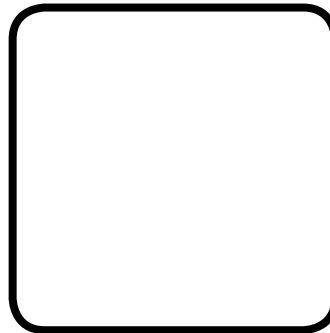
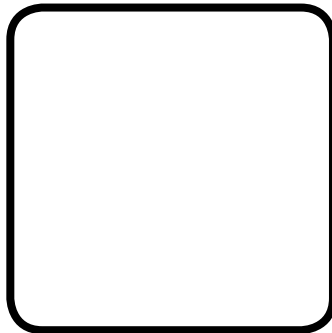
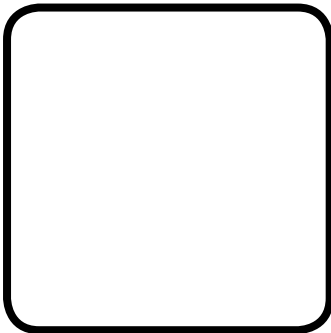
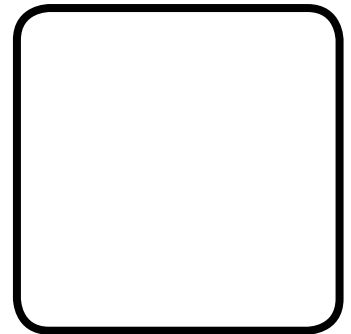
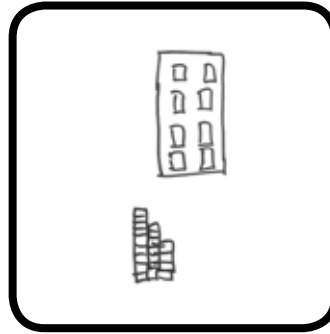
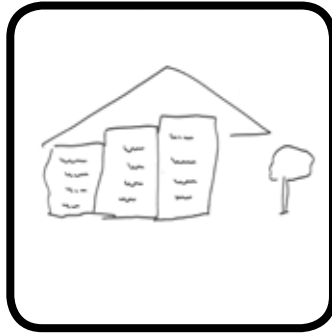

CONCLUSIONES:

CAMF - ALCUESCAR

REFERENTE: PABELLÓN MULTIUSOS	GRUPO: USUARIOS
--------------------------------------	-----------------

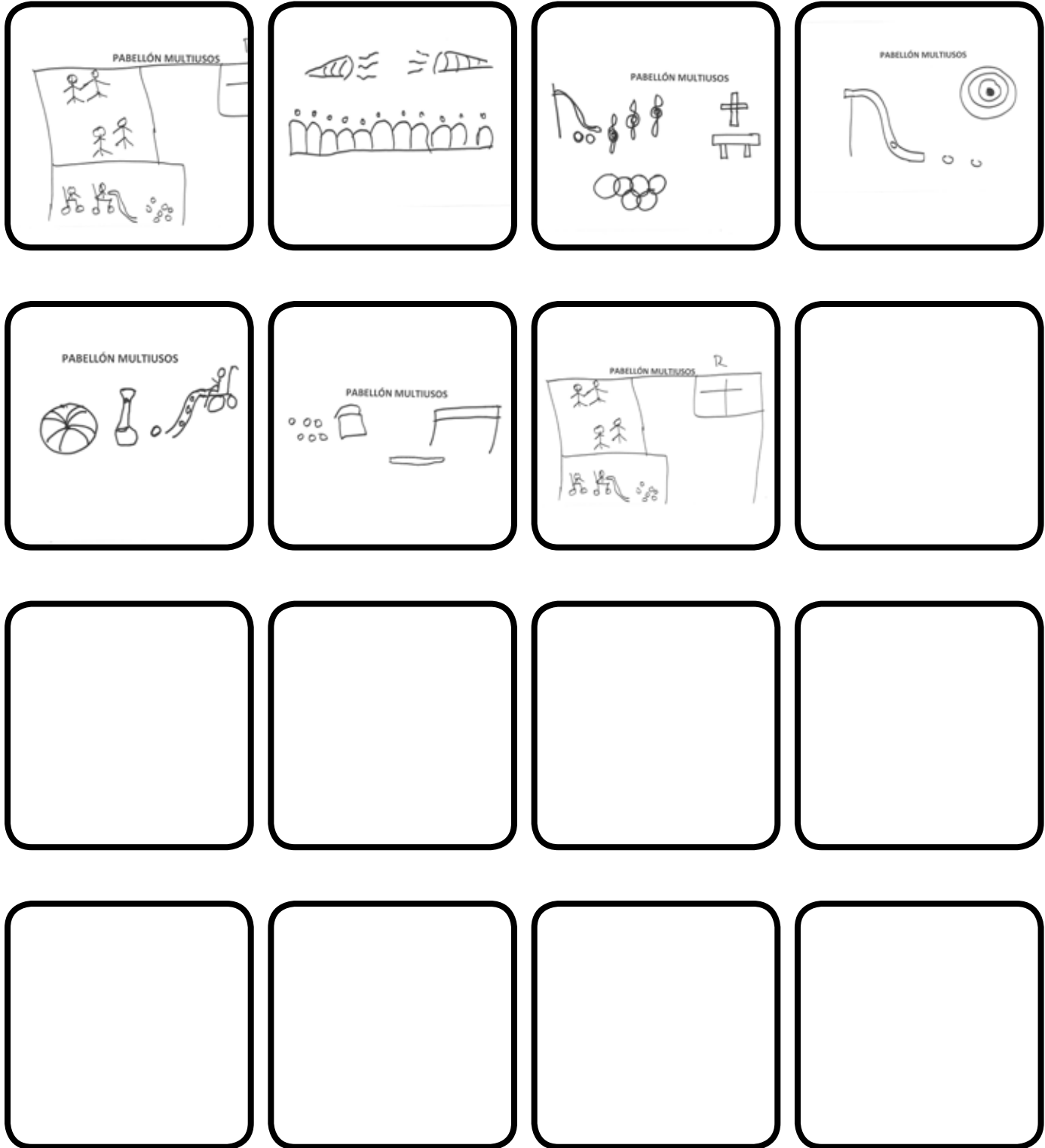

CONCLUSIONES:

CAMF - ALCUESCAR

REFERENTE: **SALA DE CURAS**

GRUPO: **USUARIOS**

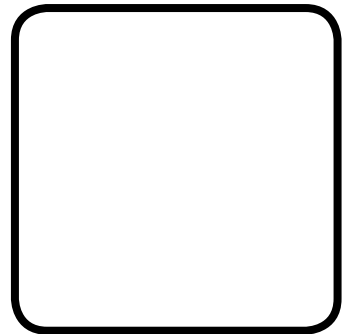
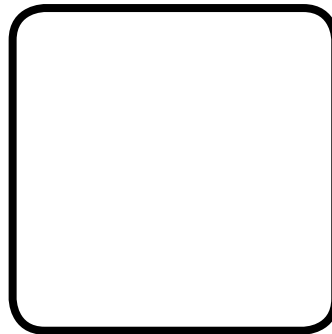
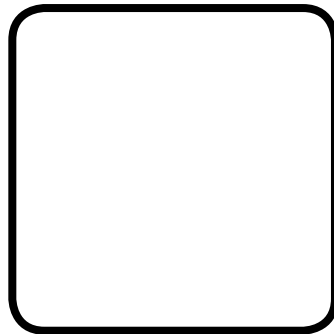
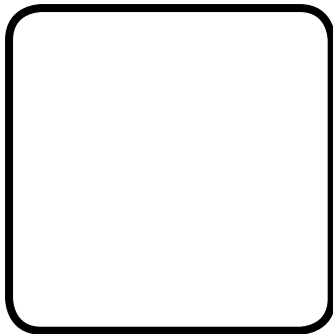
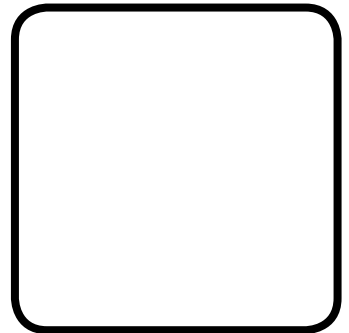
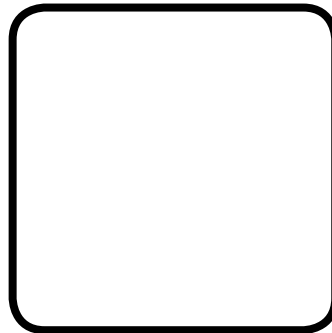
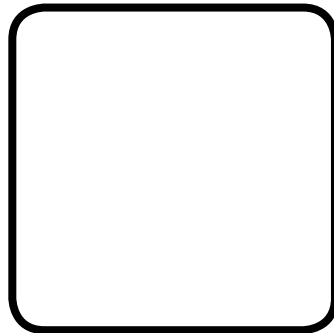
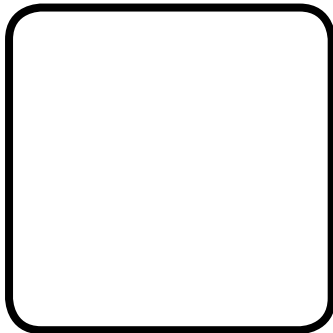
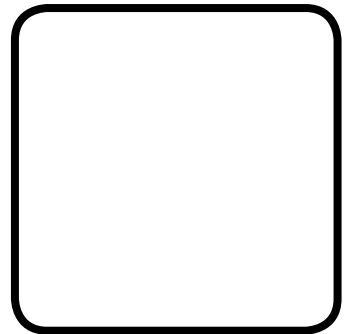
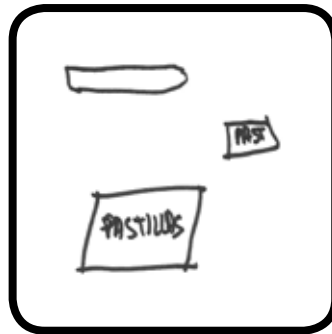

CONCLUSIONES:

CAMF - ALCUESCAR

REFERENTE: **SALA DE ENCUADERNACIÓN**

GRUPO: **USUARIOS**

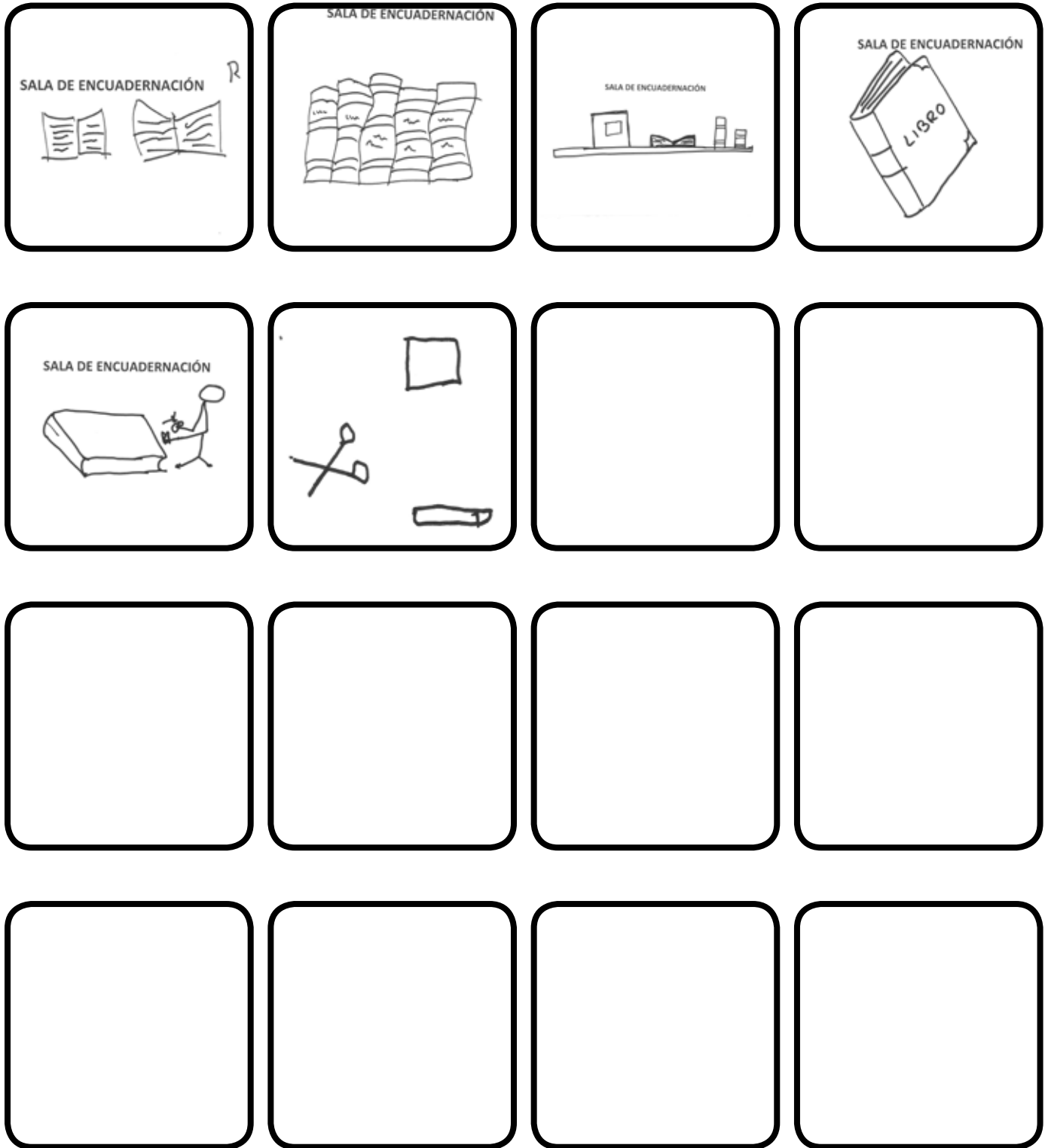

CONCLUSIONES:

CAMF - ALCUESCAR

REFERENTE: **SALA DE ENFERMERÍA**

GRUPO: USUARIOS

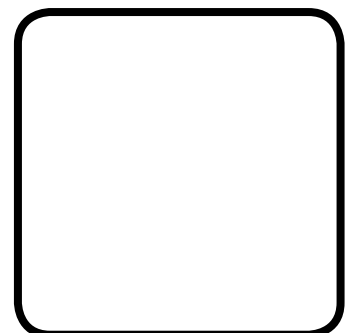
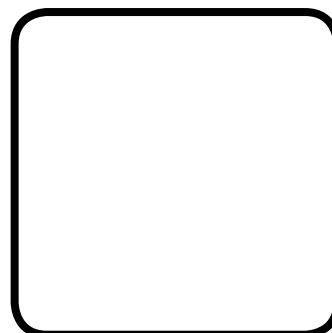
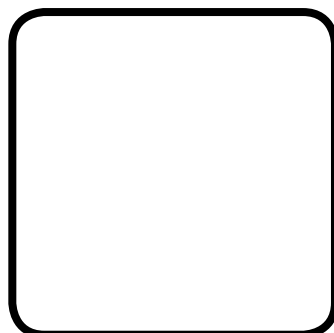
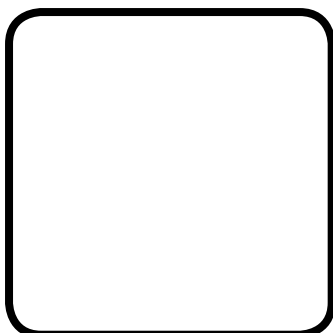
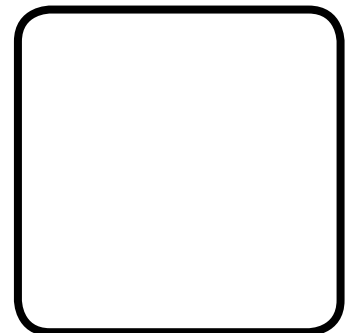
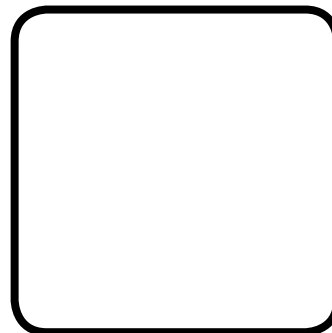
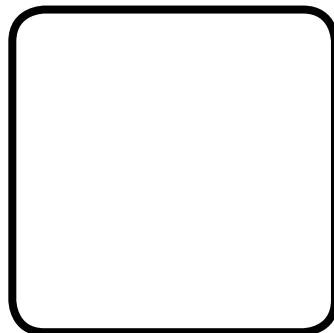
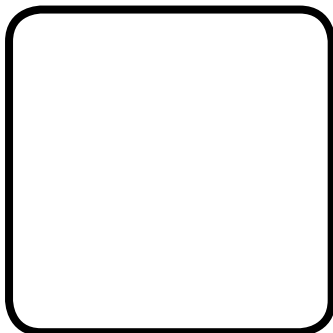
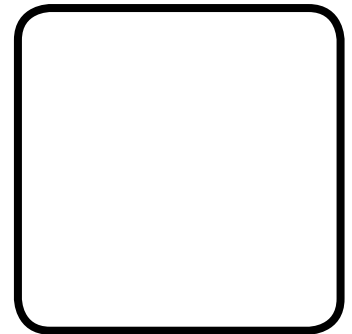
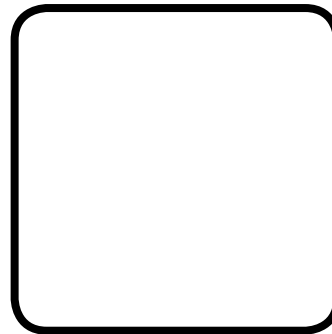
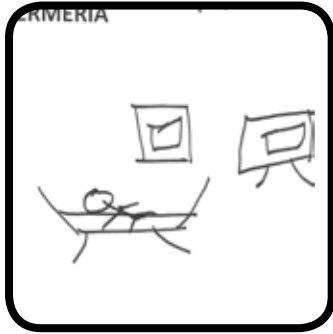

CONCLUSIONES:

CAMF - ALCUESCAR

REFERENTE: **SALA DE FISIOTERAPIA**

GRUPO: **USUARIOS**

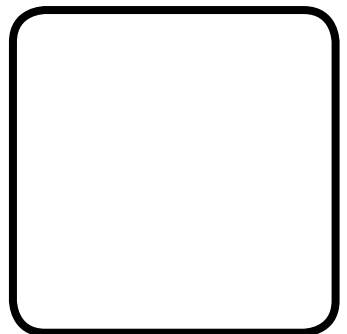
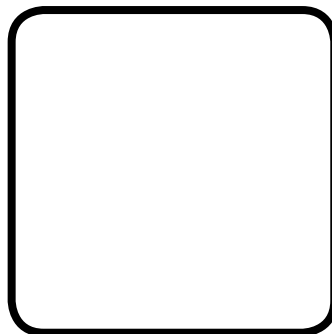
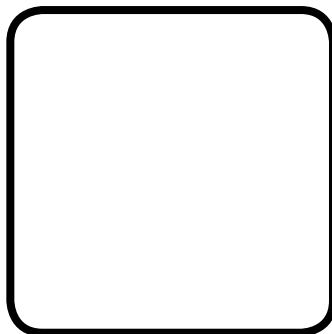
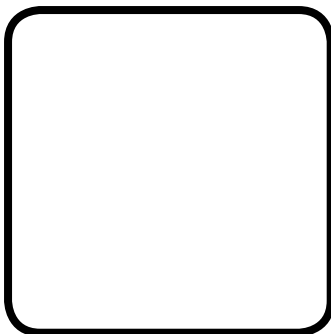
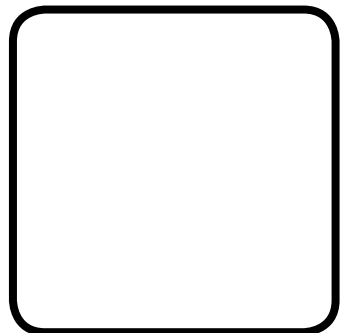
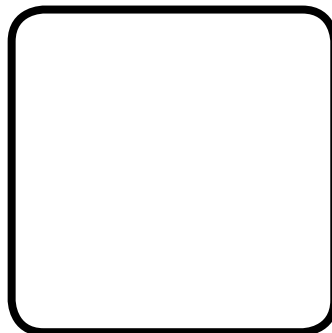
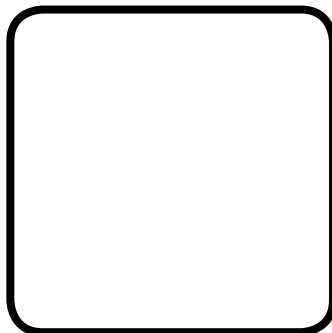
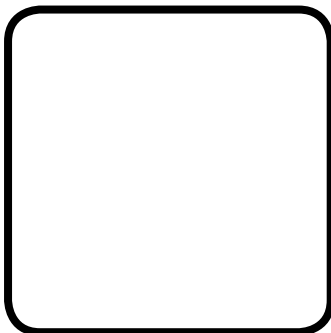
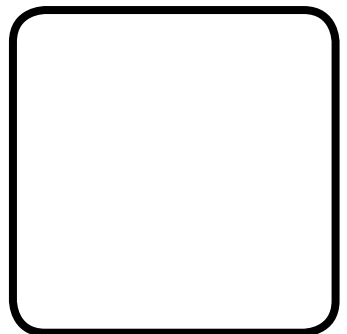
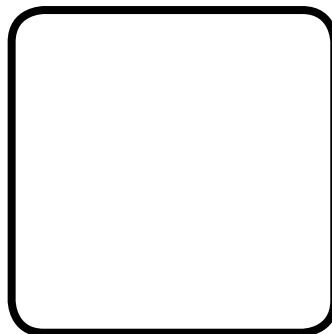
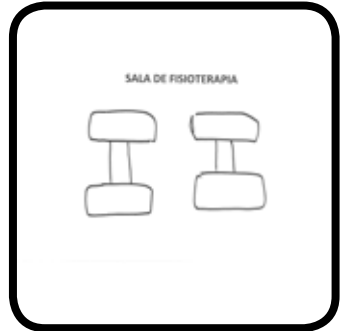
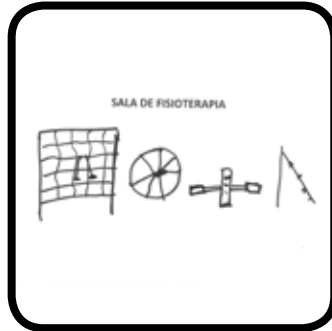

CONCLUSIONES:

CAMF - ALCUESCAR

REFERENTE: **SALA DE LOGOPEDIA**

GRUPO: USUARIOS

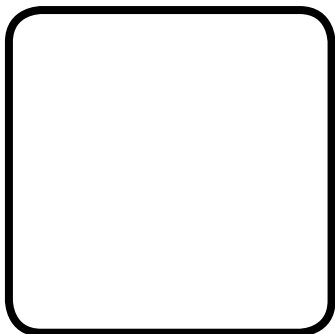
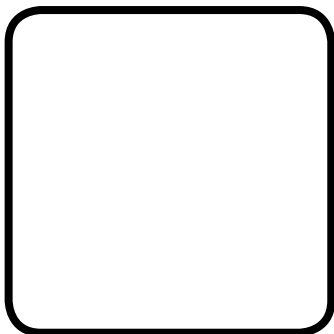
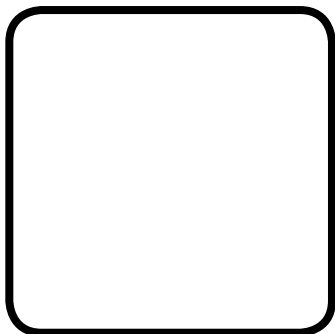
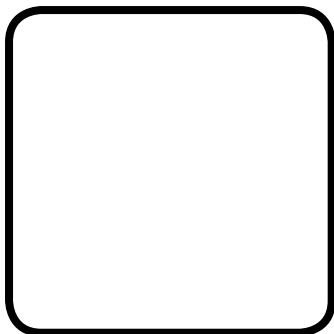
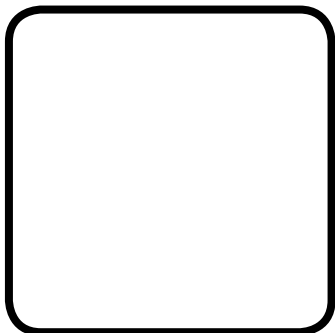
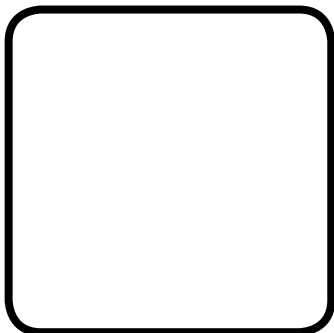
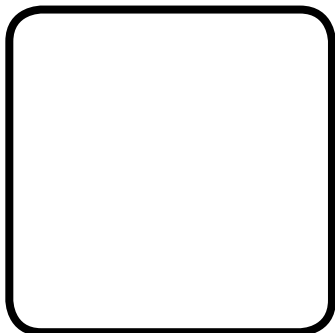
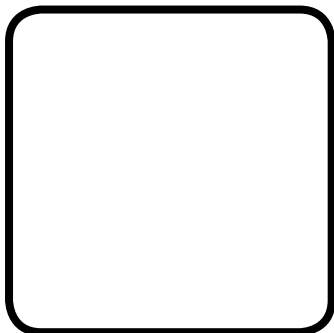
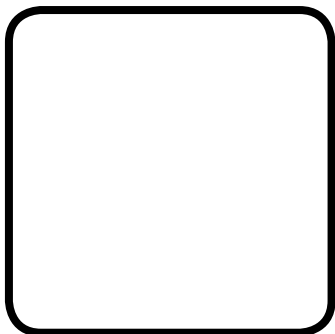
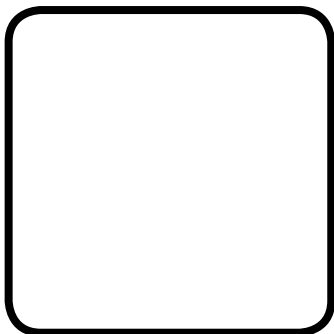
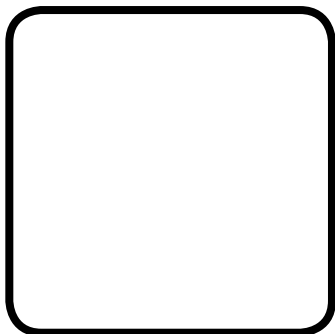
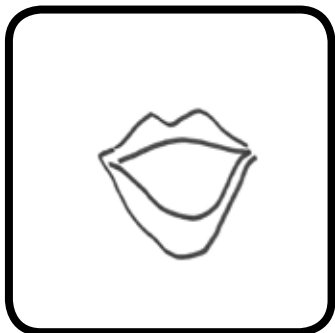
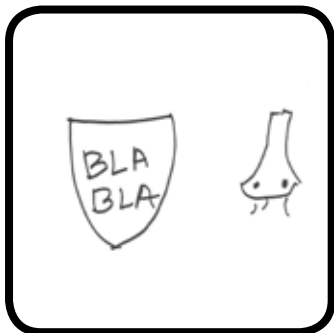

CONCLUSIONES:

CAMF - ALCUESCAR

REFERENTE: SALA DE TÉCNICAS DE ENFERMERÍA

GRUPO: USUARIOS

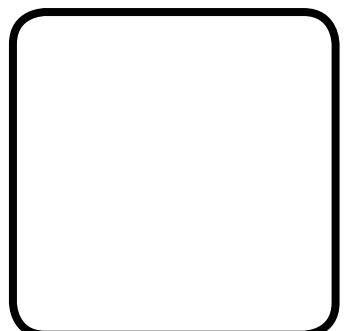
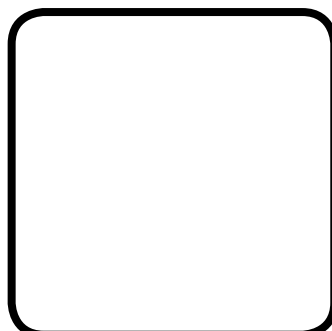
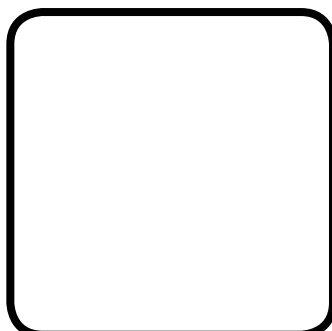
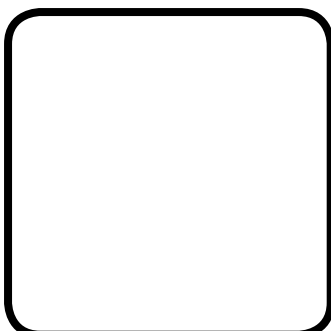
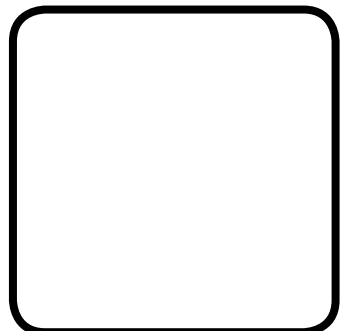
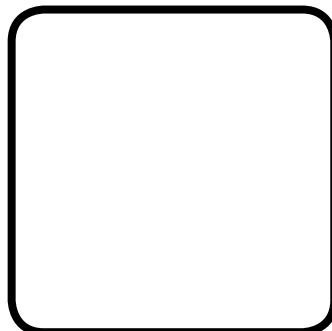
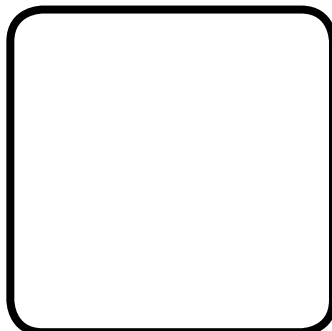
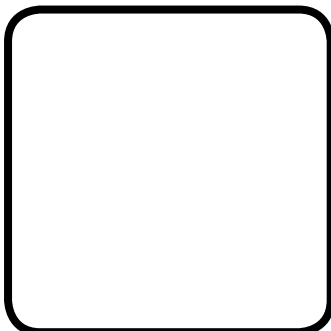
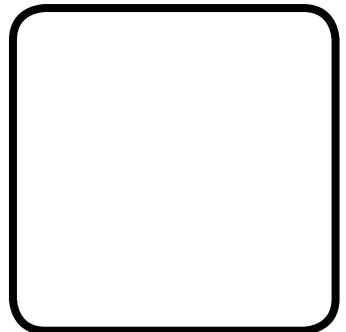
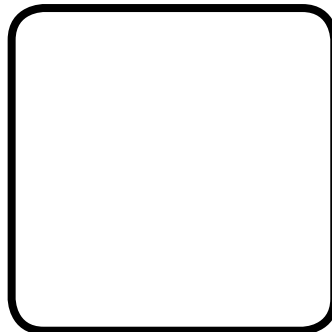
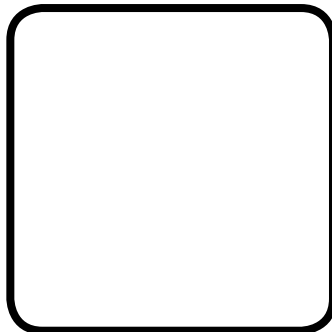
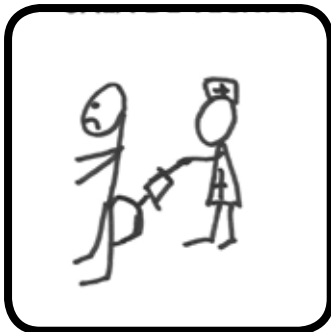
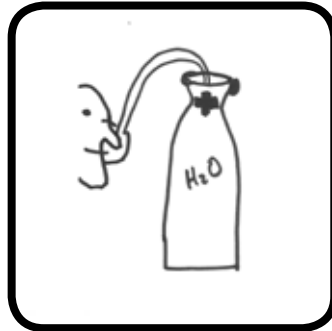
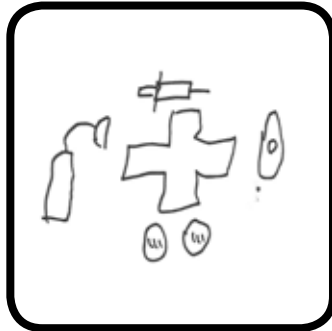
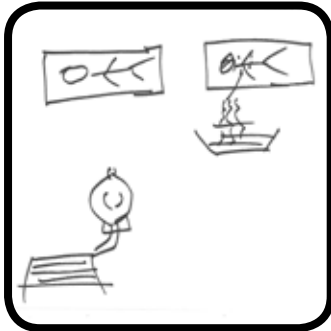

CONCLUSIONES:

CAMF - ALCUESCAR

REFERENTE: SALA DE TERAPIA OCUPACIONAL

GRUPO: USUARIOS

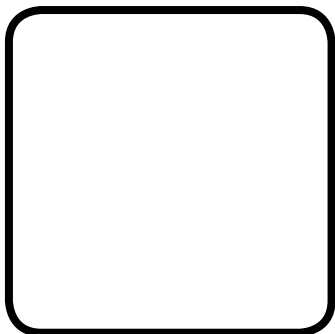
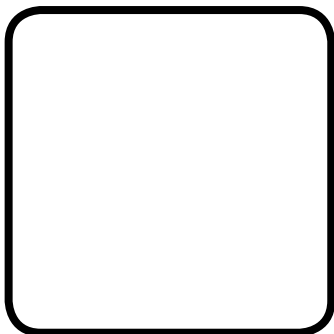
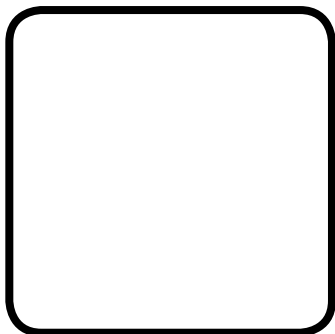
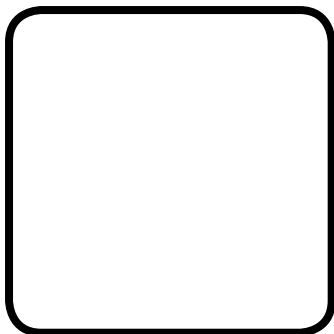
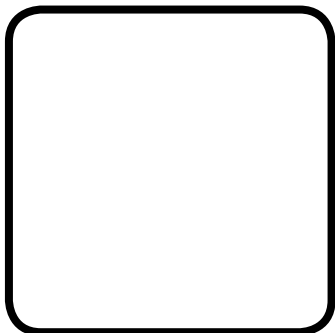
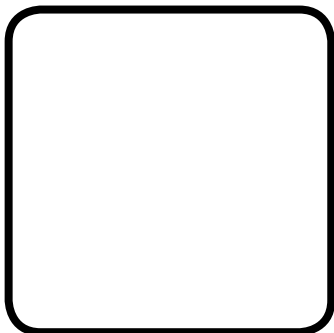
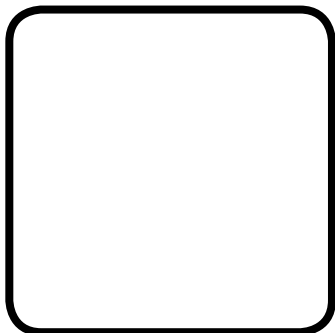
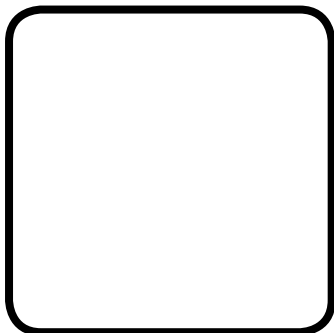
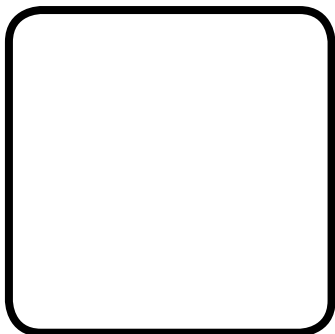
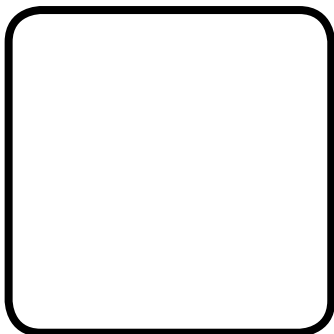
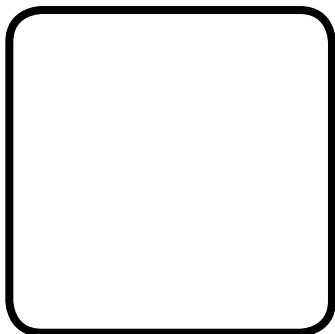
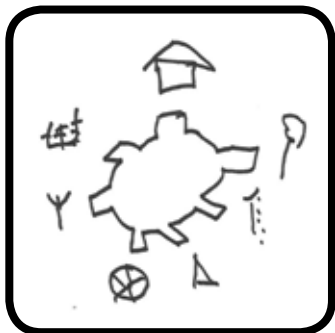

CONCLUSIONES:

CAMF - ALCUESCAR

REFERENTE: TALLER OCUPACIONAL	GRUPO: USUARIOS
-------------------------------	-----------------

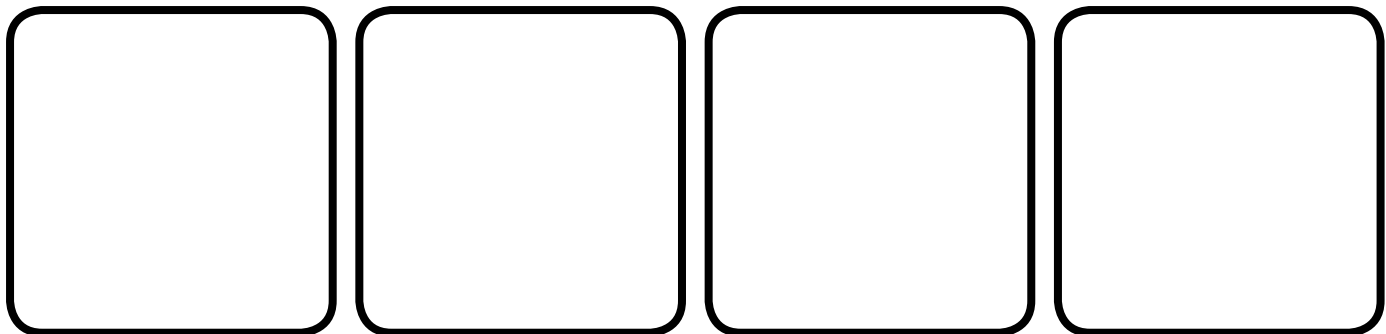
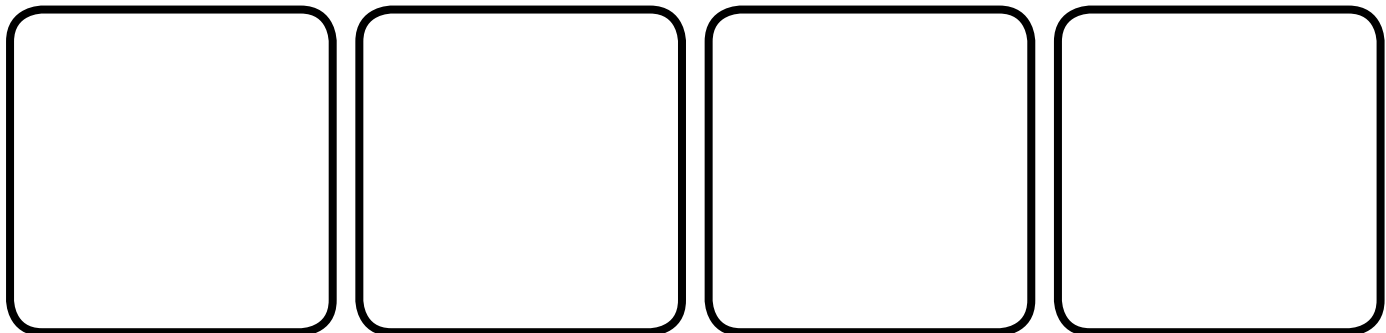
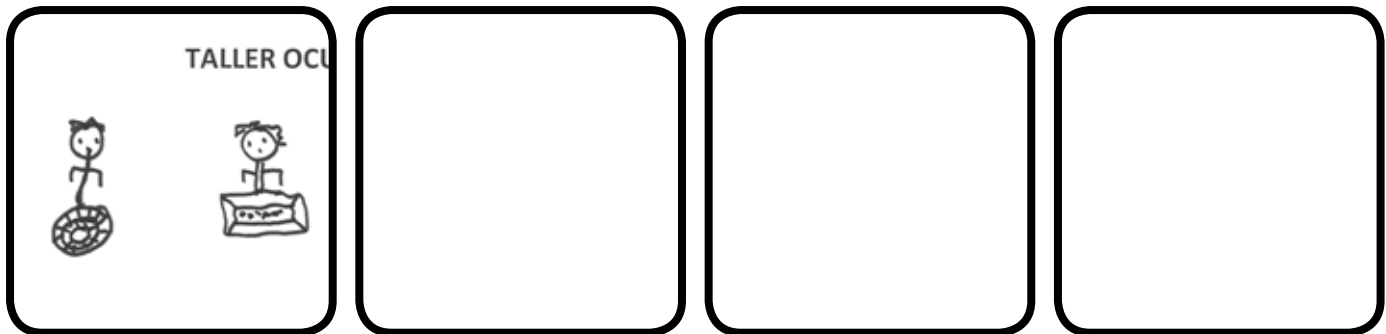
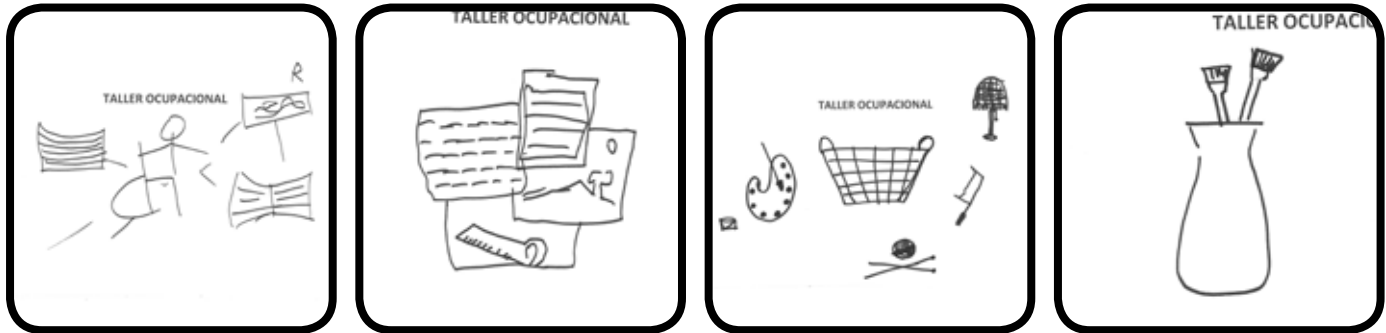

CONCLUSIONES:

CENTRO DE PROMOCIÓN DE AUTONOMÍA PERSONAL

LOCALIDAD: BERGONDO

GRUPO: PROFESIONALES

CENTRO DE PROMOCIÓN DE AUTONOMÍA PERSONAL - BERGONDO

REFERENTE: AULA DE FORMACIÓN

GRUPO: PROFESIONALES

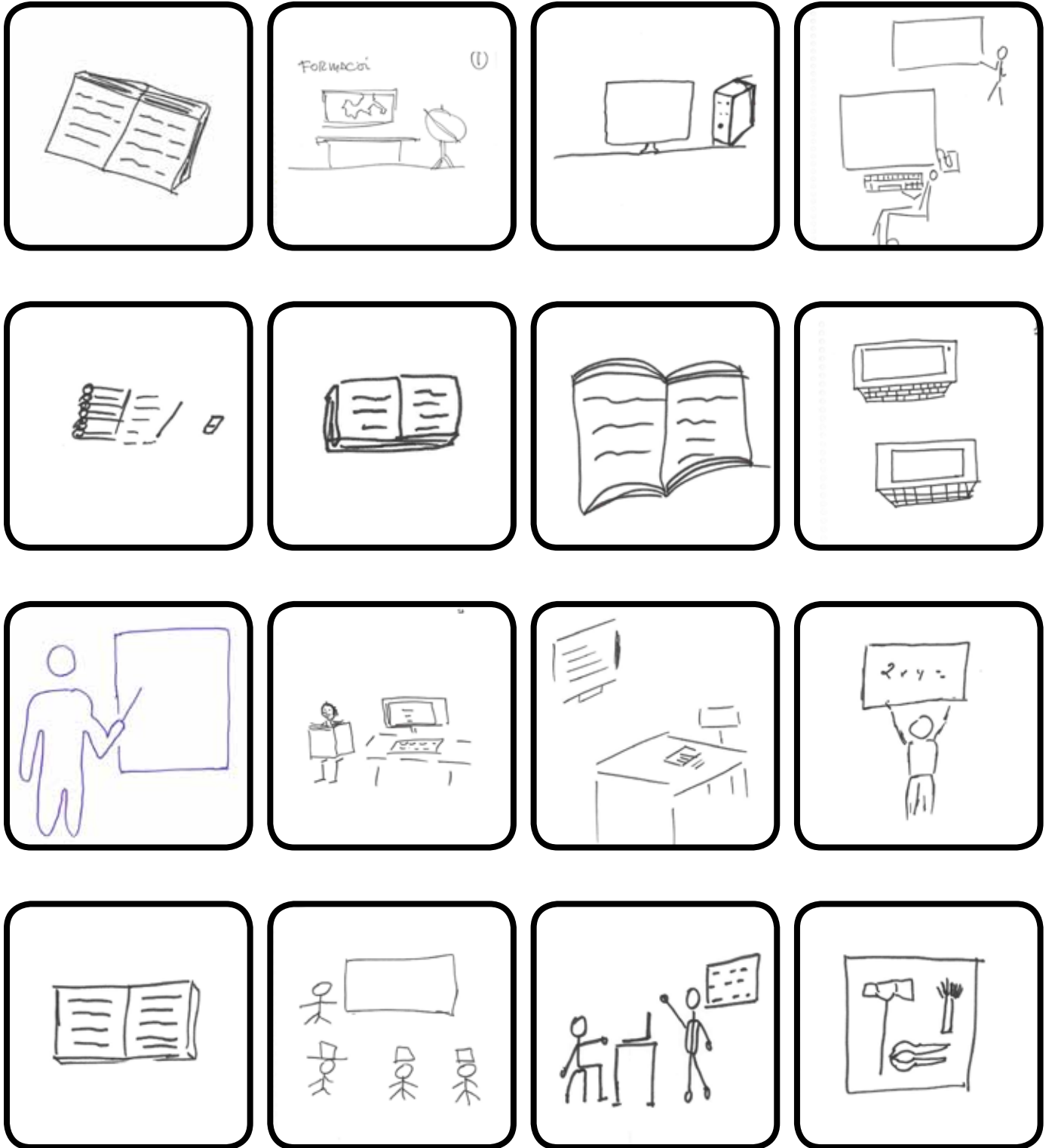

CONCLUSIONES:

CENTRO DE PROMOCIÓN DE AUTONOMÍA PERSONAL - BERGONDO

REFERENTE: COMEDOR RESIDENTES

GRUPO: PROFESIONALES

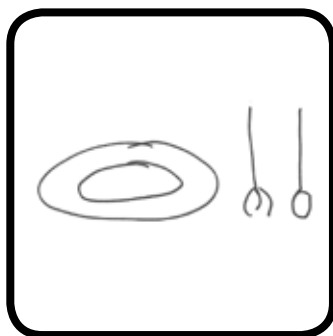
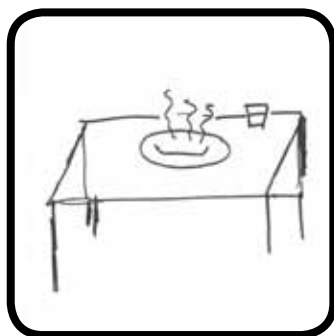
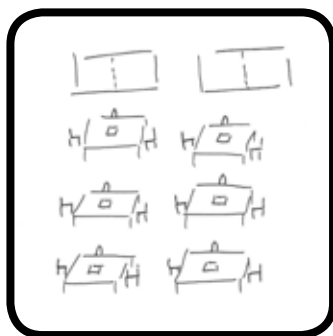
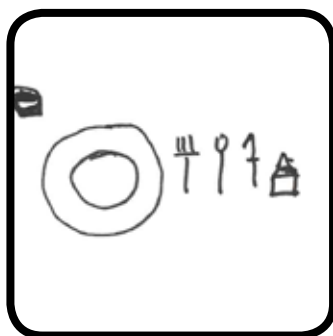
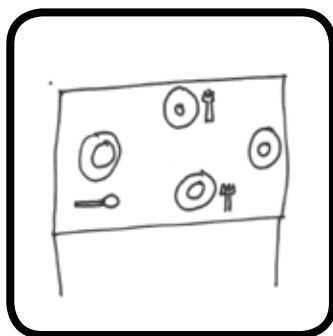
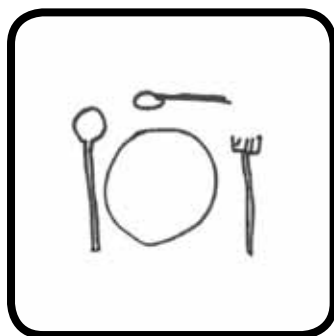
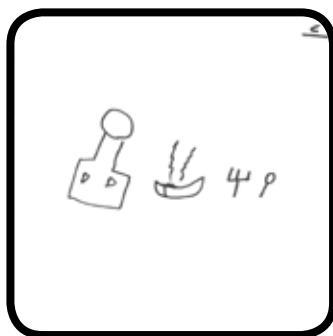
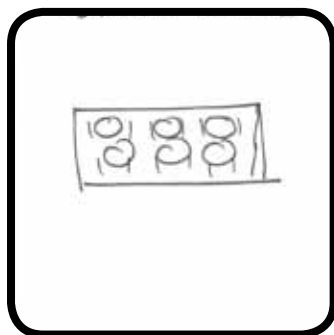
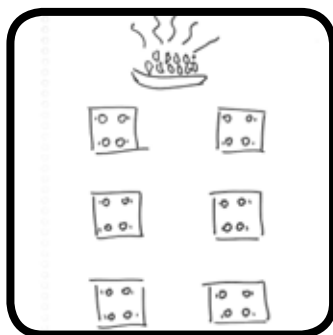

CONCLUSIONES:

CENTRO DE PROMOCIÓN DE AUTONOMÍA PERSONAL - BERGONDO

REFERENTE: **CONSEJERÍA**

GRUPO: PROFESIONALES

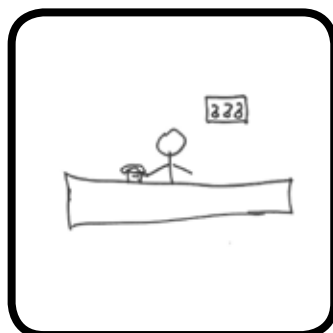
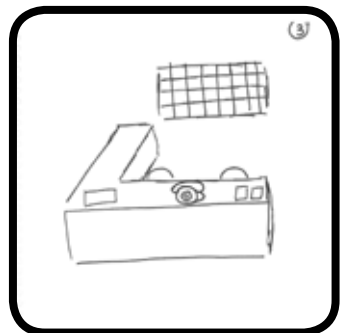
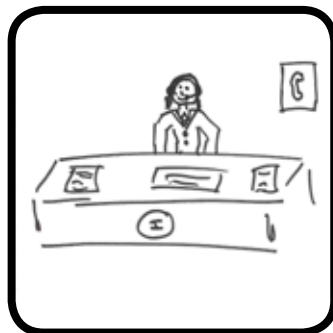
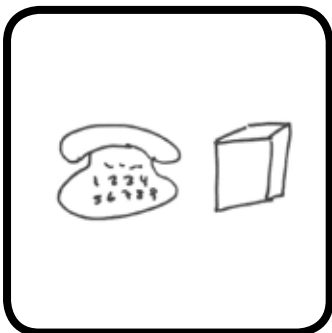
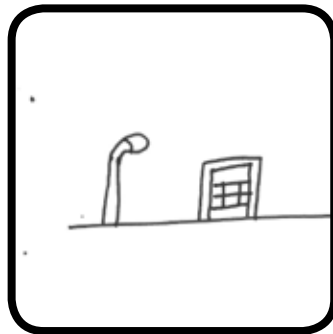
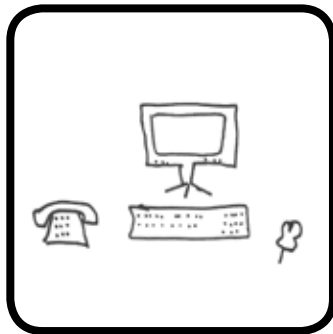
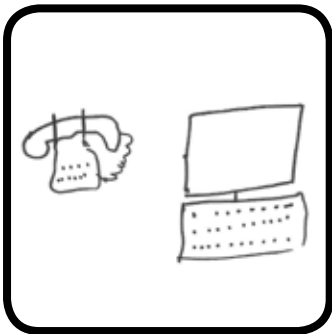
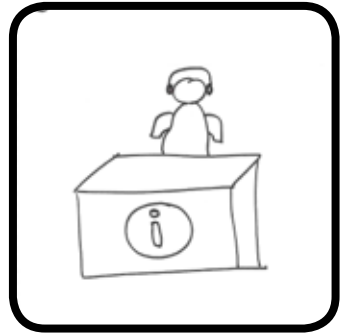
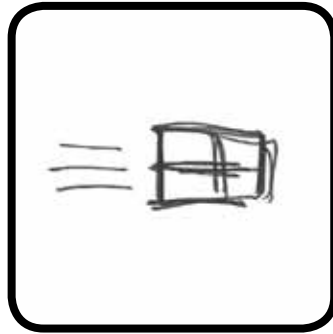
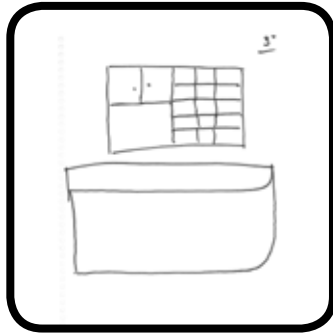

CONCLUSIONES:

CENTRO DE PROMOCIÓN DE AUTONOMÍA PERSONAL - BERGONDO

REFERENTE: **DESPACHO JEFE ESTUDIOS**

GRUPO: PROFESIONALES

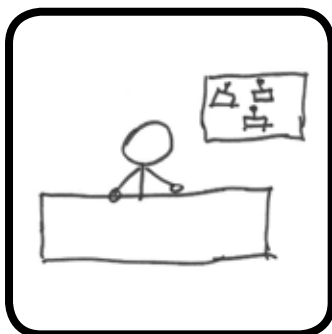
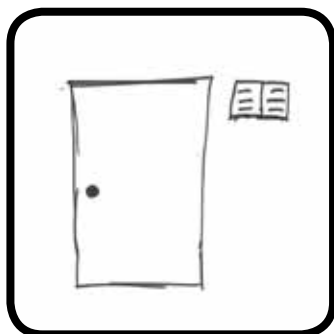
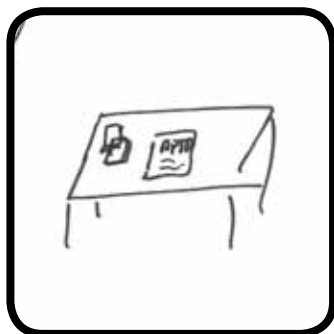
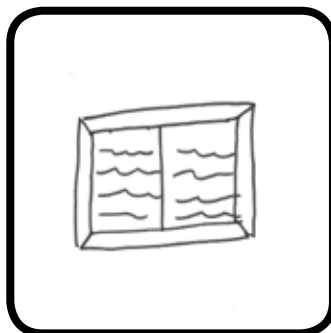
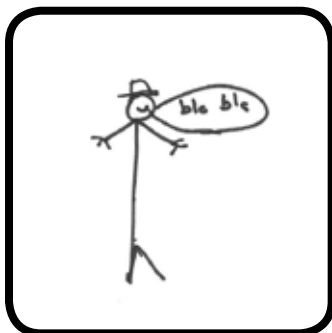
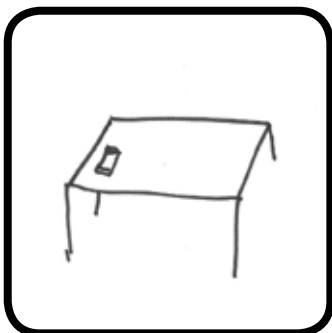
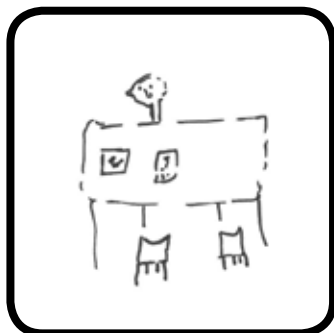
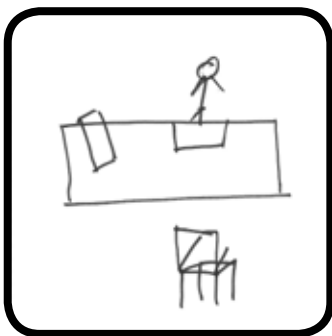
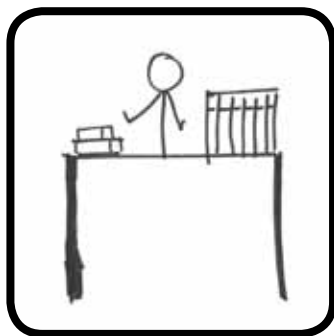

CONCLUSIONES:

CENTRO DE PROMOCIÓN DE AUTONOMÍA PERSONAL - BERGONDO

REFERENTE: DESPACHO LOGOPEDA

GRUPO: PROFESIONALES

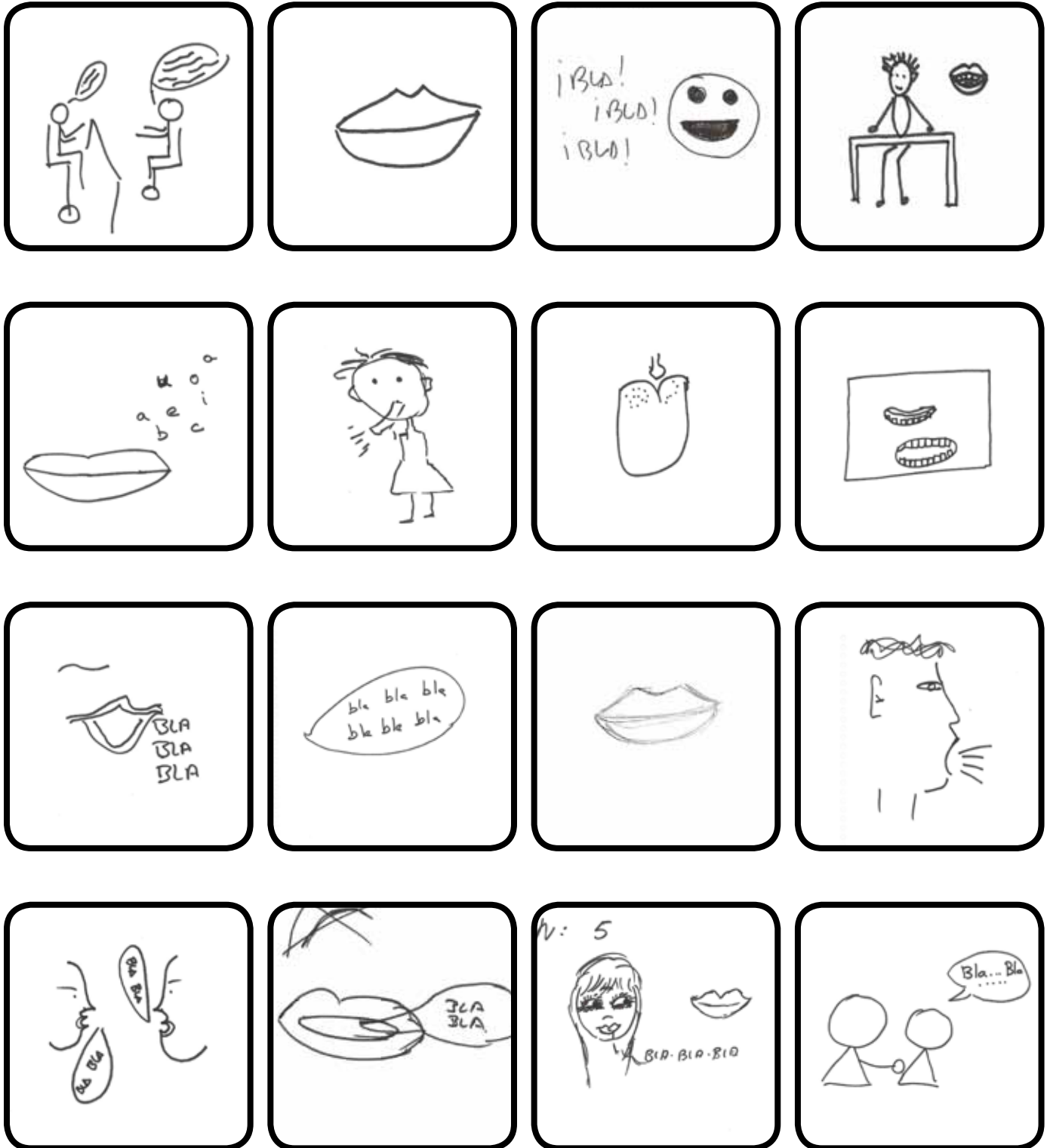

CONCLUSIONES:

CENTRO DE PROMOCIÓN DE AUTONOMÍA PERSONAL - BERGONDO

REFERENTE: DESPACHO PSICÓLOGO

GRUPO: PROFESIONALES

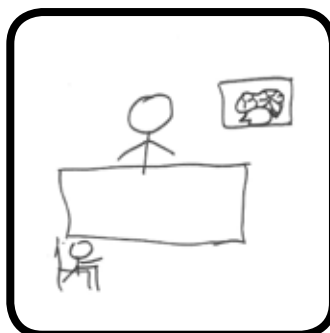
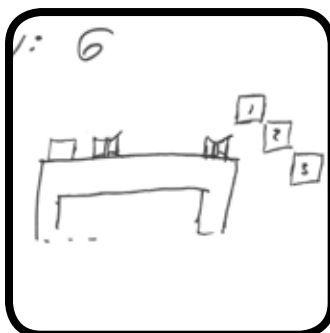
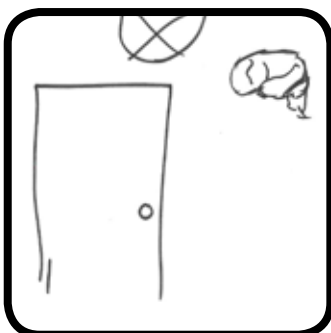
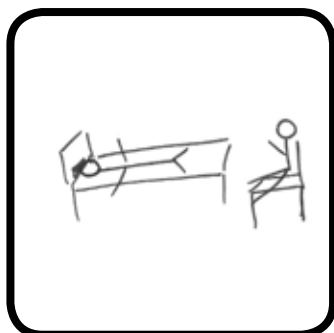
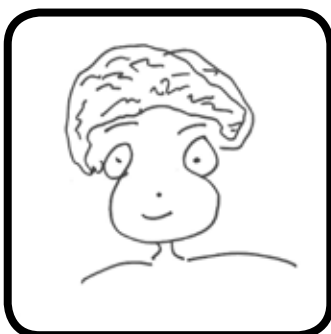
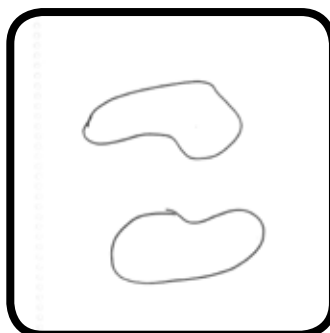
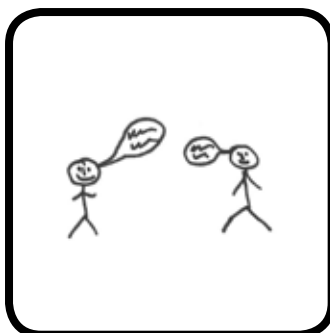
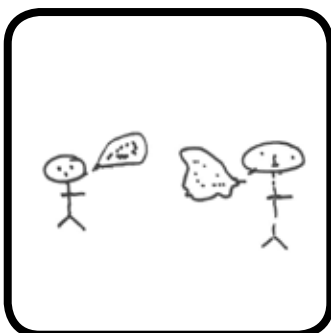
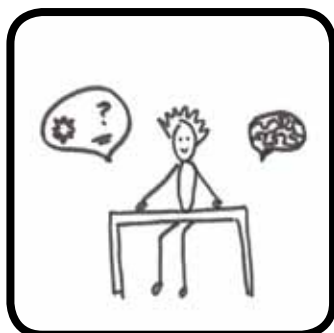
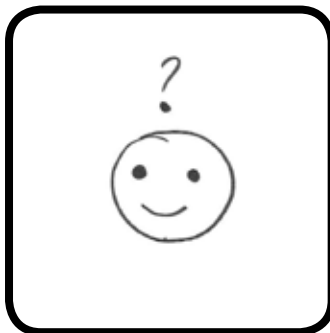
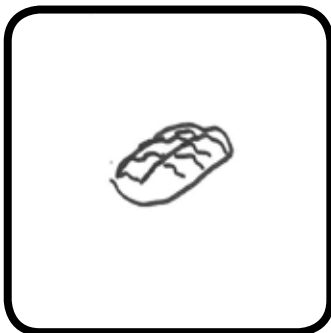
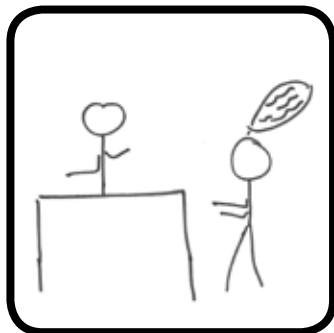

CONCLUSIONES:

CENTRO DE PROMOCIÓN DE AUTONOMÍA PERSONAL - BERGONDO

REFERENTE: RESPONSABLE ÁREA ASISTENCIAL

GRUPO: PROFESIONALES

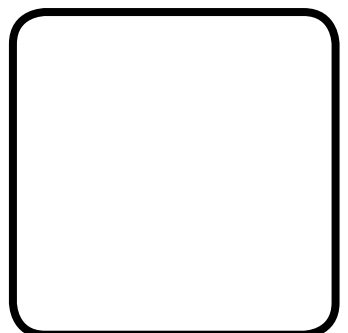
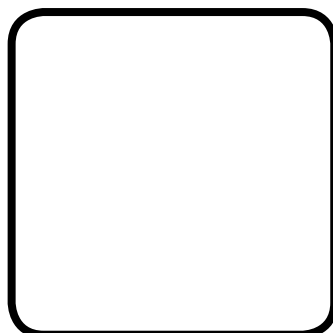
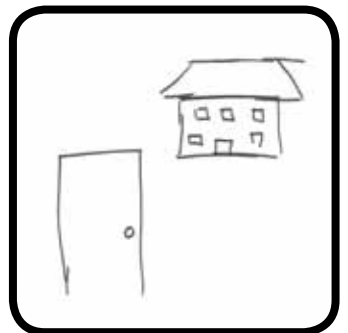
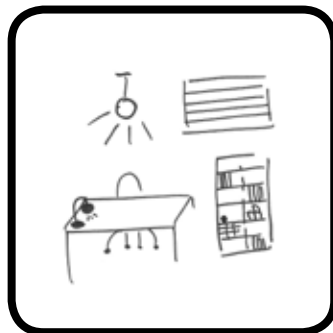
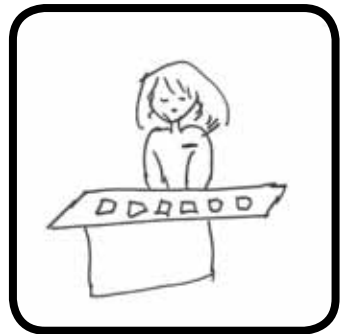
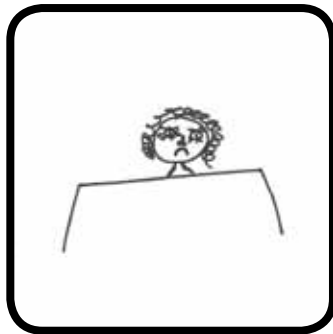
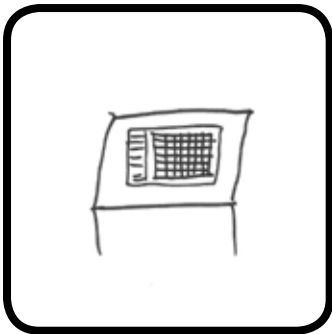
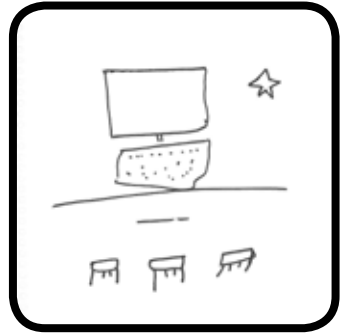
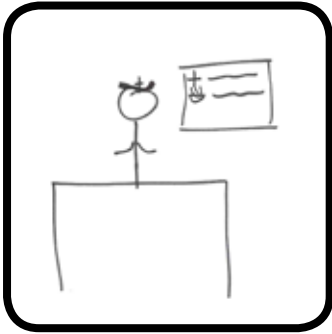

CONCLUSIONES:

CENTRO DE PROMOCIÓN DE AUTONOMÍA PERSONAL - BERGONDO

REFERENTE: TÉCNICO ORIENTACIÓN PROFESIONAL

GRUPO: PROFESIONALES

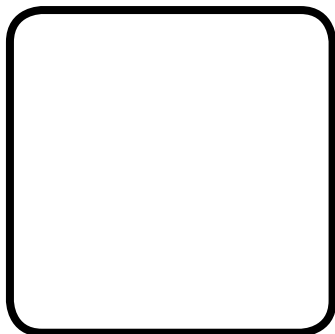
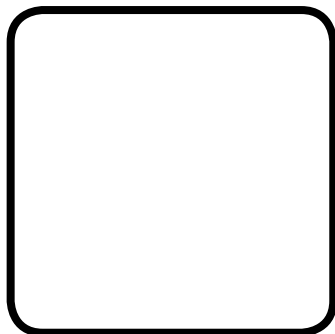
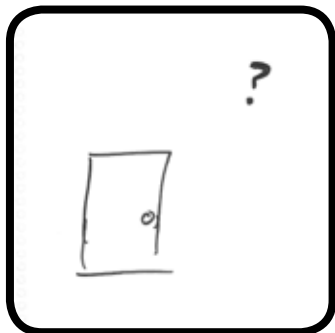
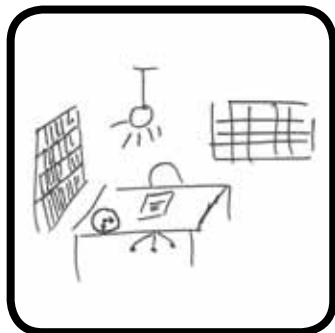
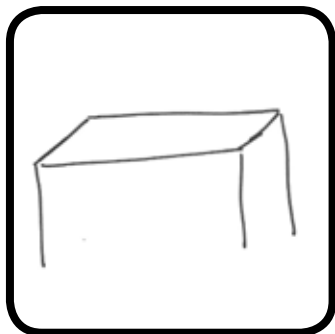
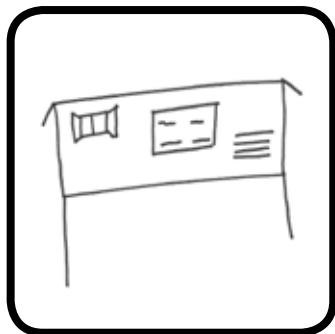
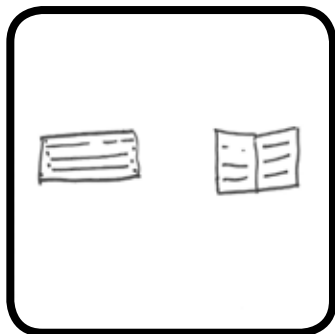
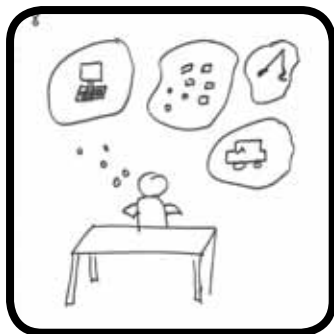
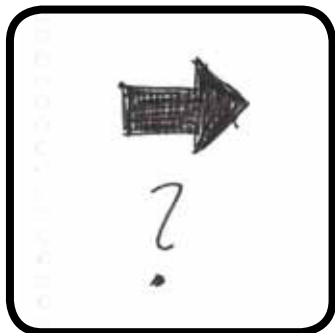
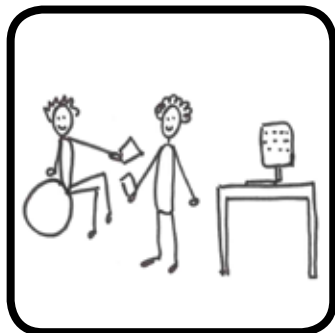
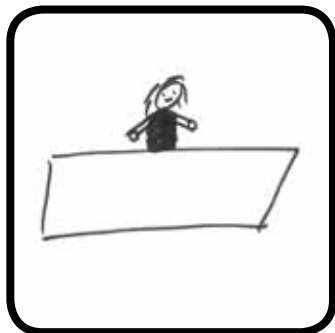
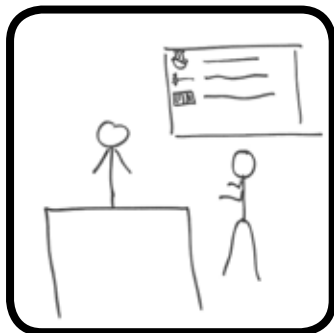

CONCLUSIONES:

CENTRO DE PROMOCIÓN DE AUTONOMÍA PERSONAL - BERGONDO

REFERENTE: TRABAJADOR SOCIAL

GRUPO: PROFESIONALES

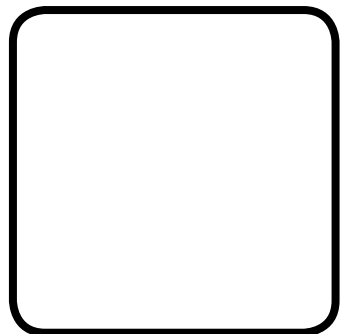
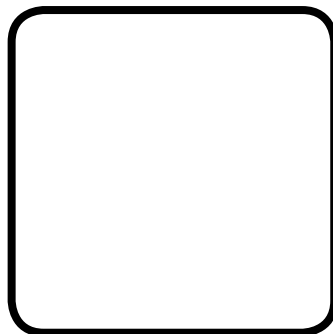
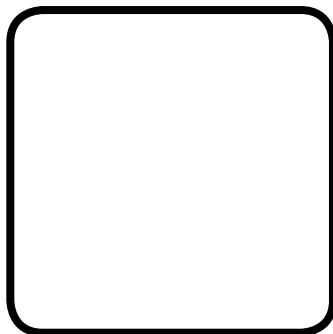
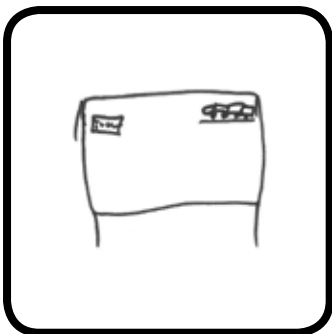
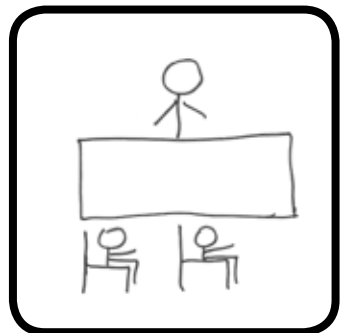
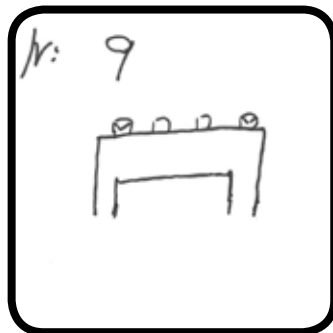
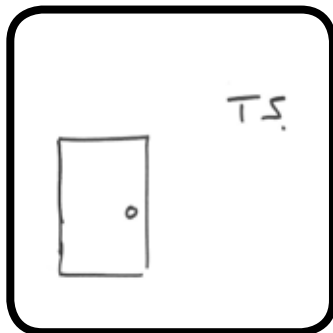
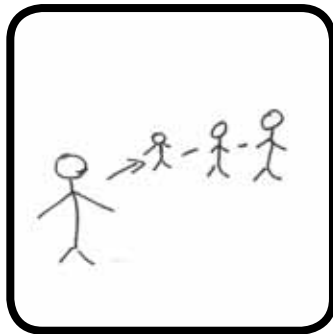
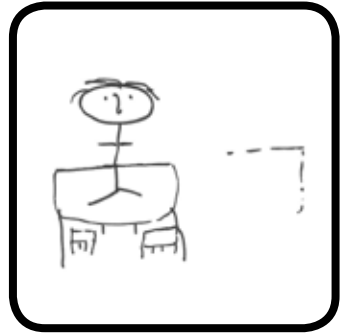
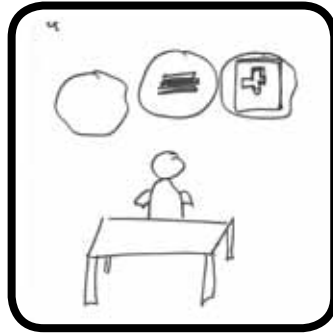

CONCLUSIONES:

CENTRO DE PROMOCIÓN DE AUTONOMÍA PERSONAL - BERGONDO

REFERENTE: **GIMNASIO**

GRUPO: PROFESIONALES

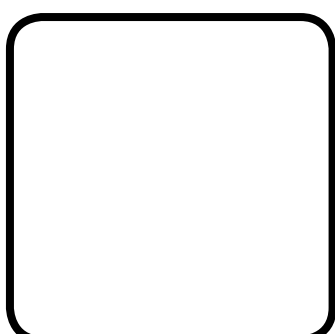
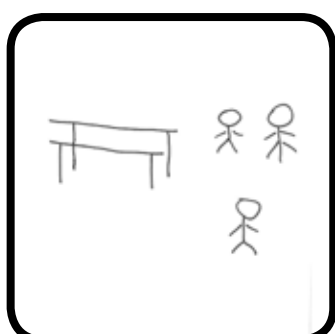
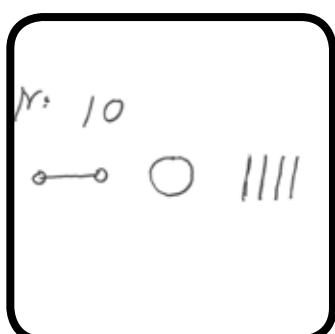
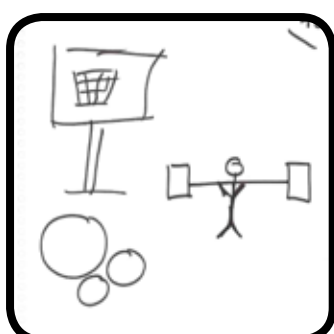
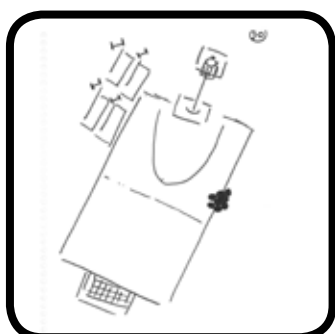
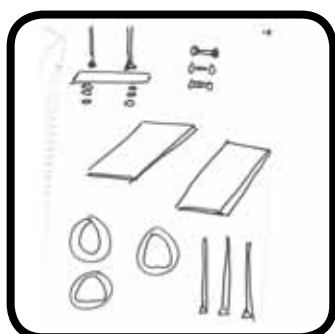
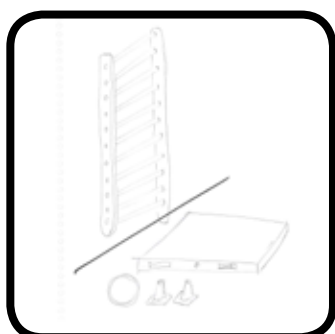
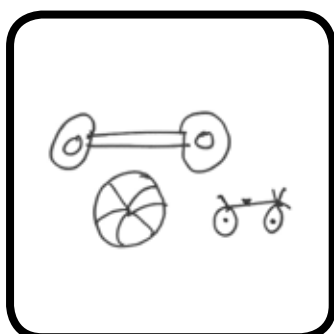
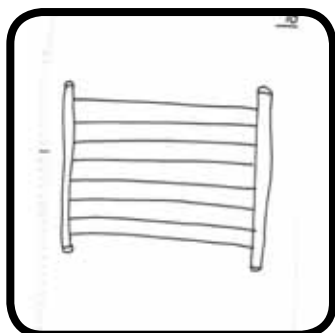
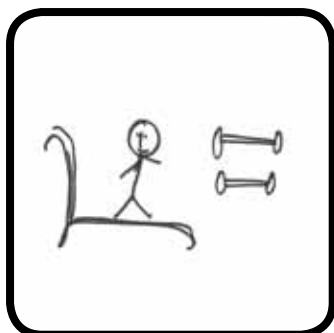
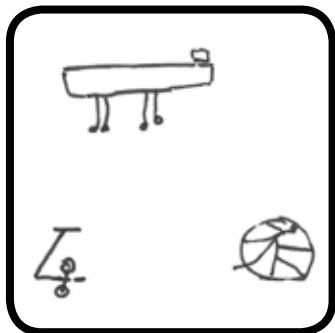
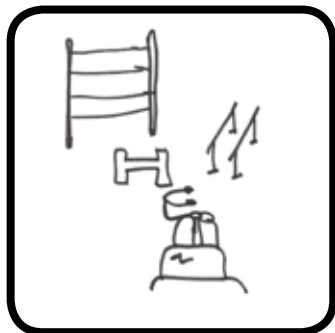
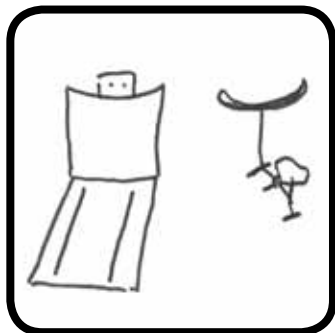
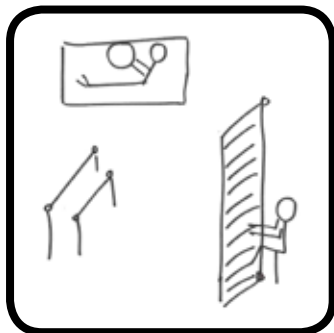

CONCLUSIONES:

CENTRO DE PROMOCIÓN DE AUTONOMÍA PERSONAL - BERGONDO

REFERENTE: SALA DE CUIDADORES

GRUPO: PROFESIONALES

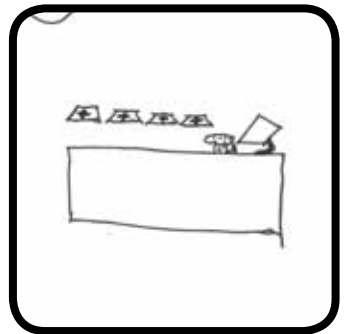
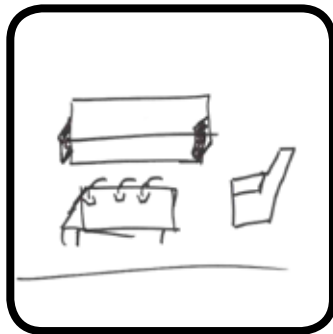
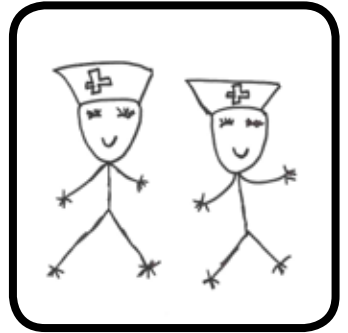
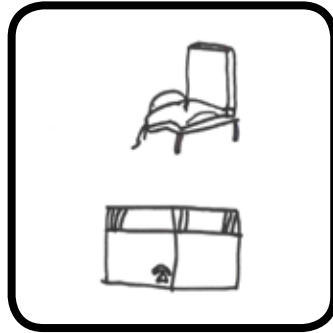
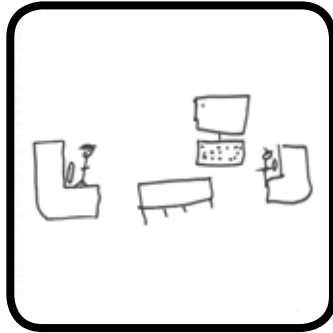
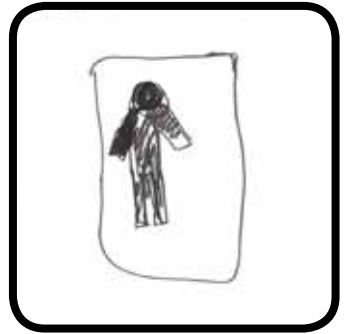
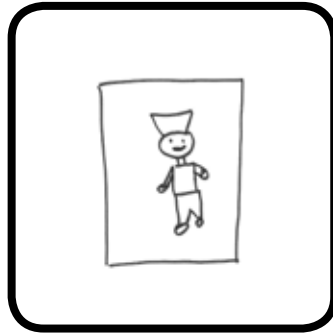
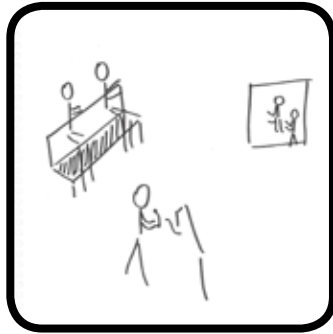

CONCLUSIONES:

CENTRO DE PROMOCIÓN DE AUTONOMÍA PERSONAL - BERGONDO

REFERENTE: SALA DE ATENCIÓN GRUPAL

GRUPO: PROFESIONALES

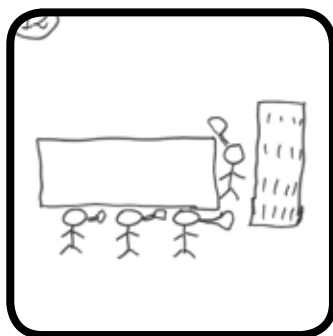
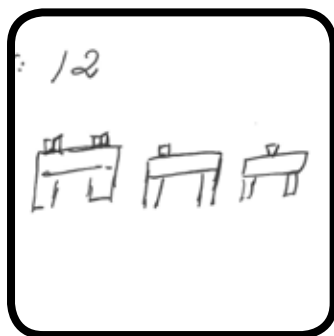
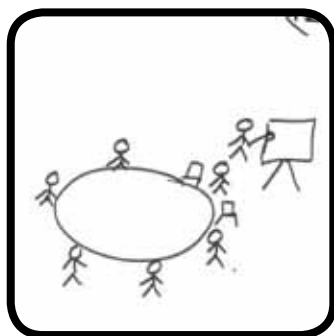
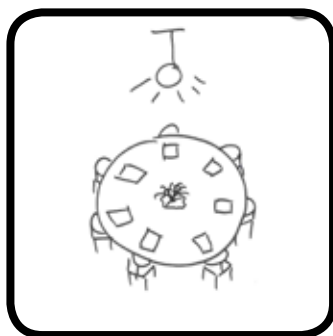
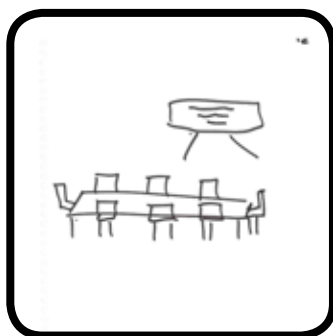
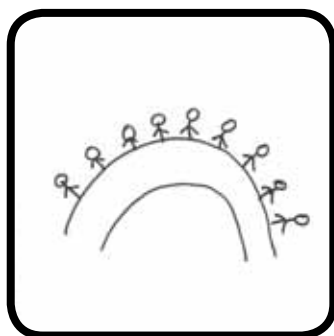
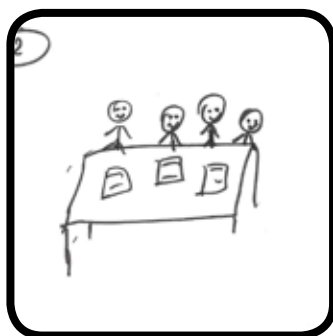
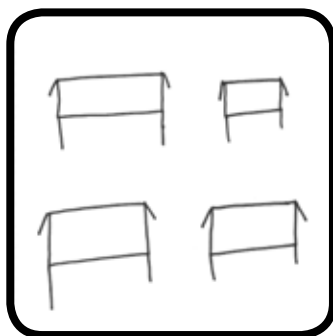
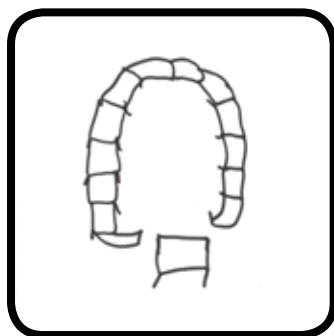
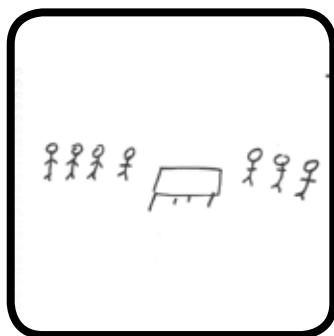
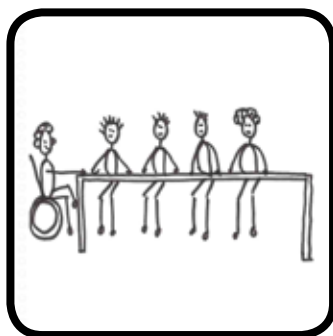
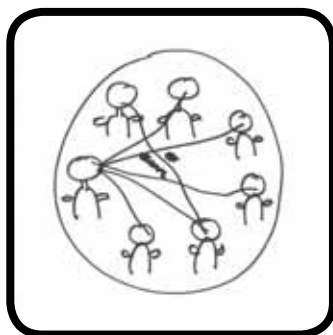
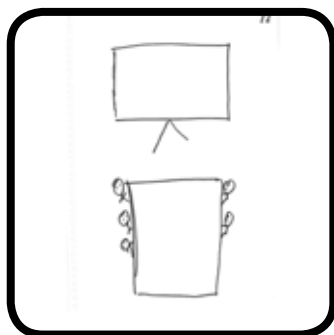

CONCLUSIONES:

CENTRO DE PROMOCIÓN DE AUTONOMÍA PERSONAL - BERGONDO

REFERENTE: SALA DE ENFERMERÍA

GRUPO: PROFESIONALES

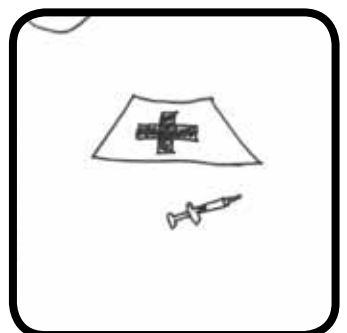
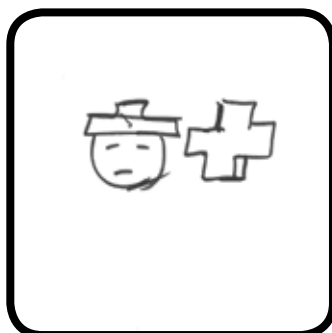
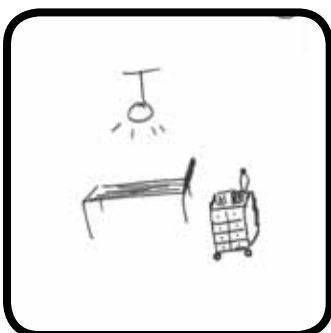
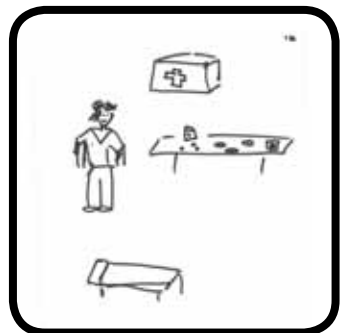
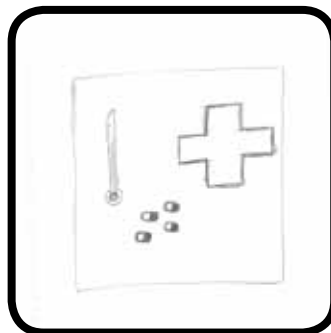
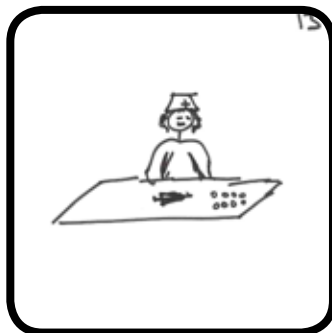
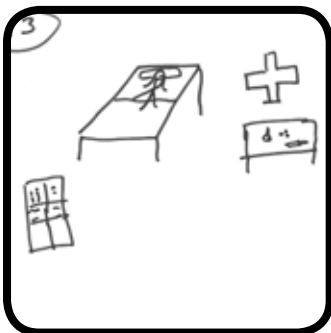
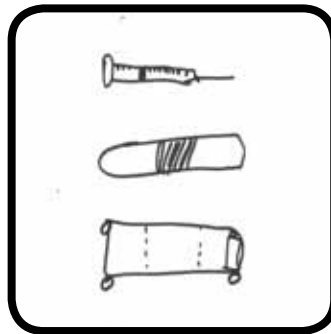
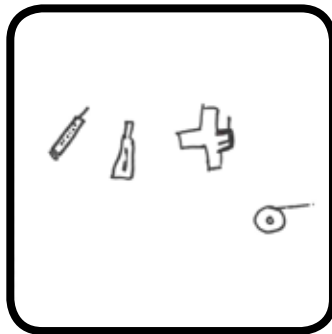
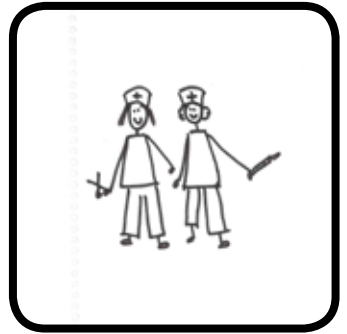
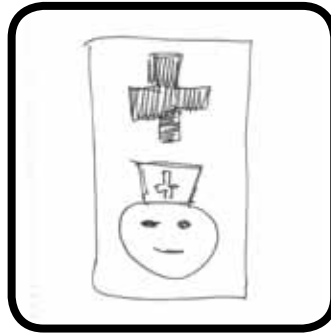
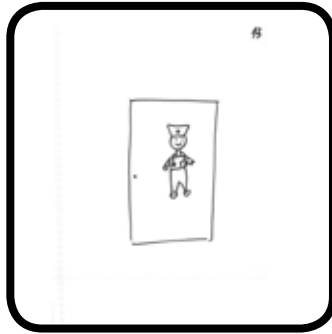
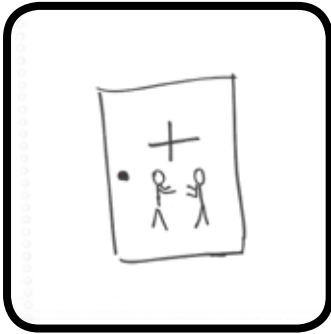

CONCLUSIONES:

CENTRO DE PROMOCIÓN DE AUTONOMÍA PERSONAL - BERGONDO

REFERENTE: **SALA DE ESTAR**

GRUPO: PROFESIONALES

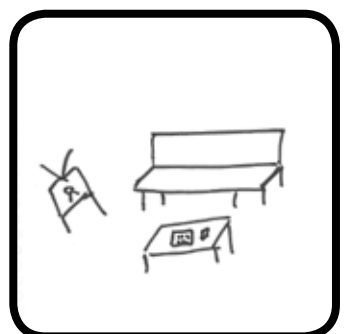
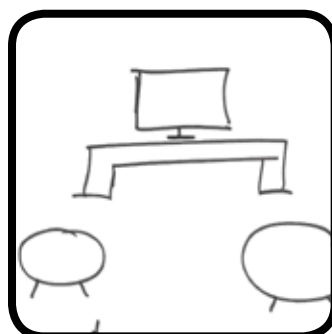
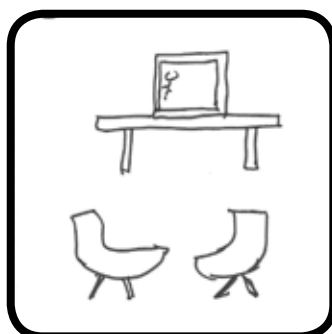
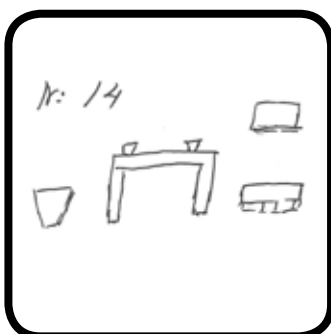
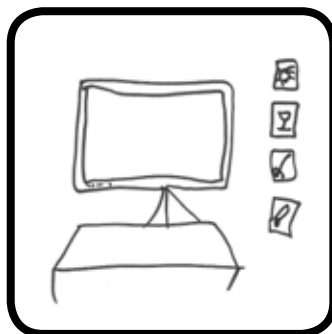
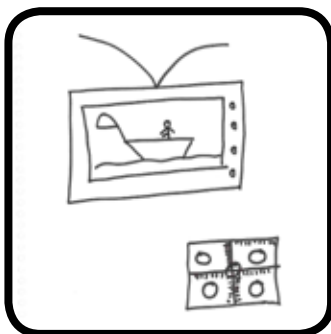
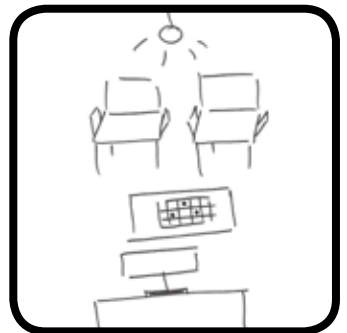
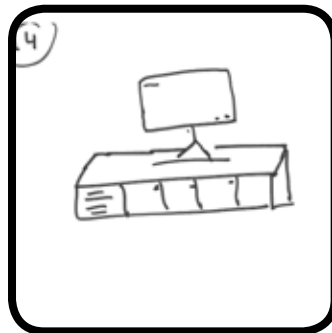
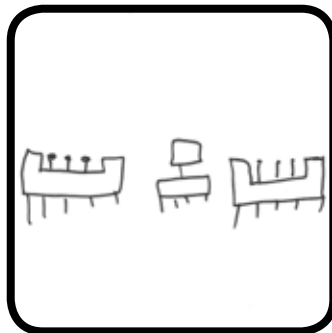
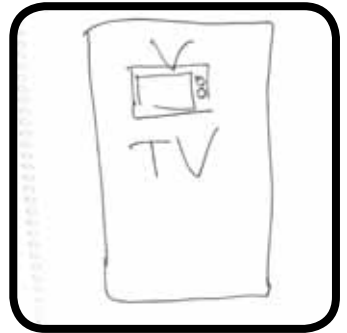
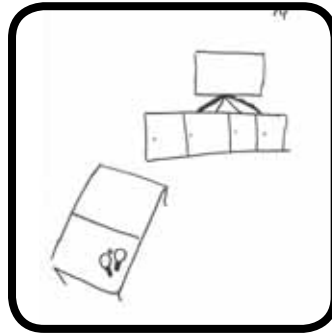
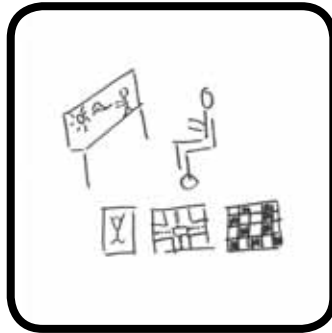

CONCLUSIONES:

CENTRO DE PROMOCIÓN DE AUTONOMÍA PERSONAL - BERGONDO

REFERENTE: SALA DE FISIOTERAPIA

GRUPO: PROFESIONALES

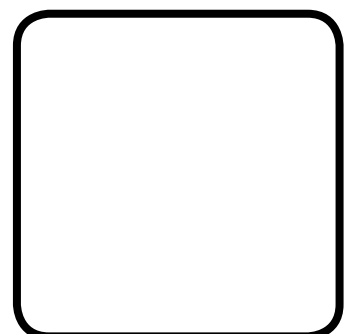
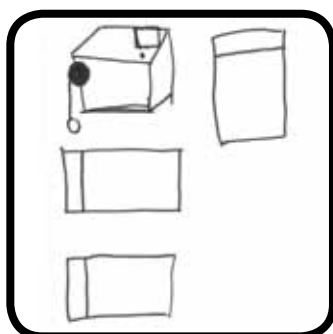
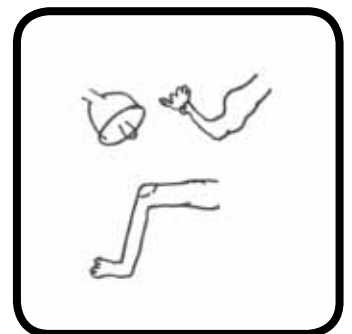
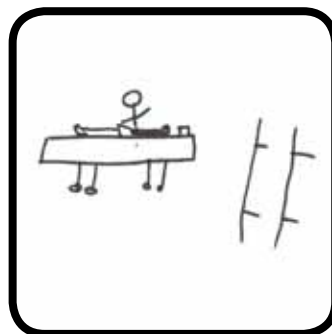
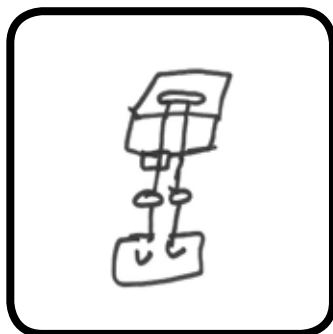
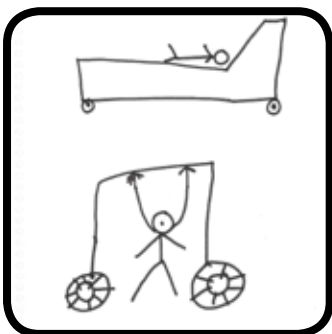
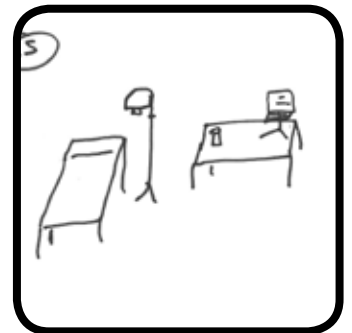
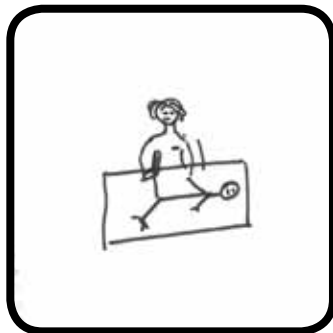
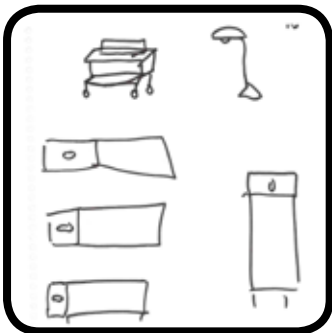
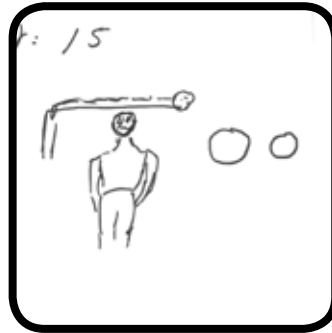
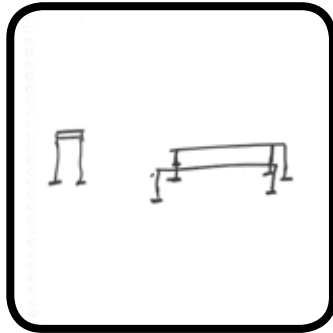
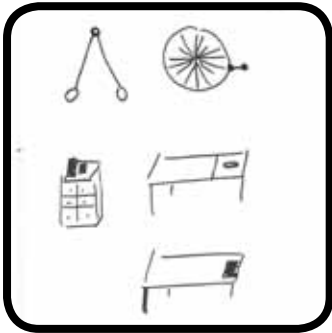

CONCLUSIONES:

CENTRO DE PROMOCIÓN DE AUTONOMÍA PERSONAL - BERGONDO

REFERENTE: SALA DE JUNTAS

GRUPO: PROFESIONALES

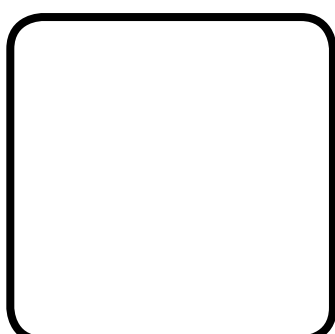
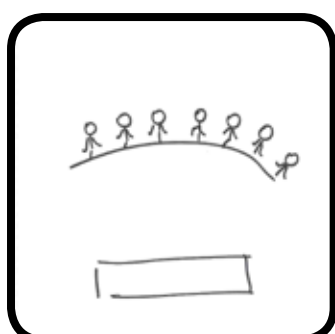
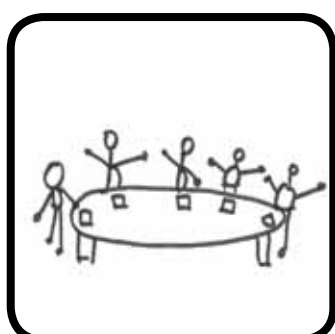
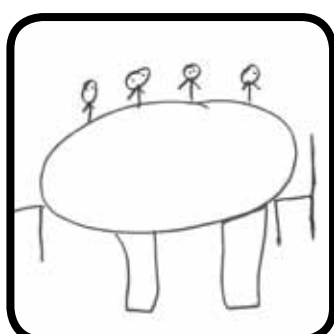
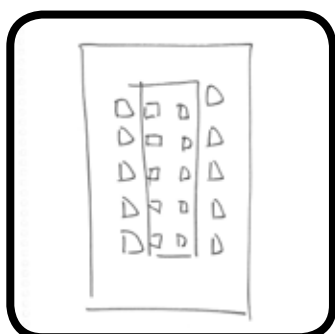
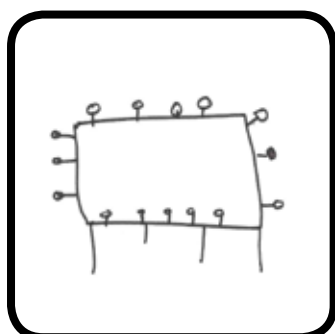
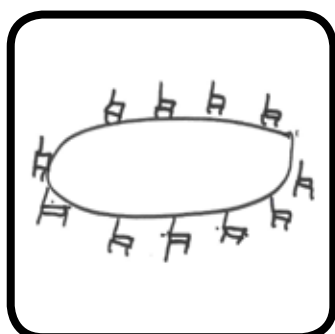
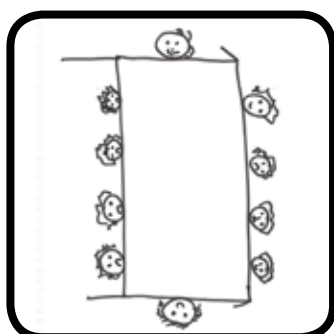
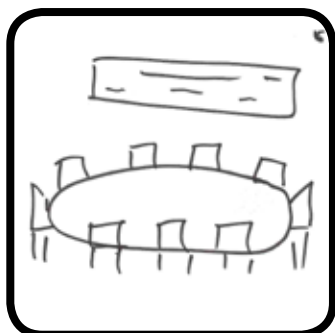
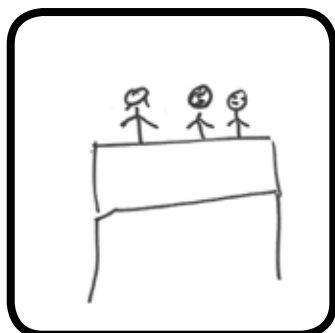
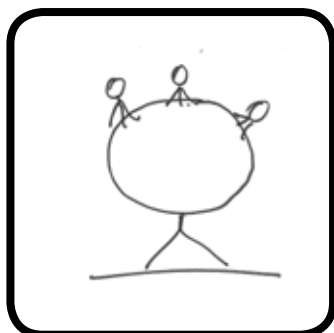
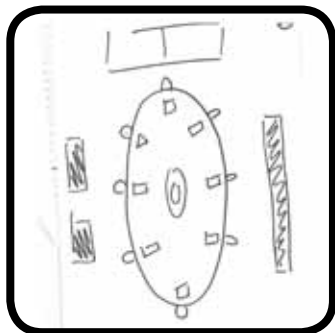
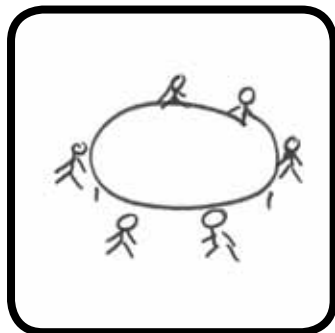
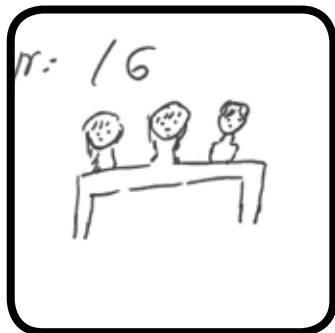
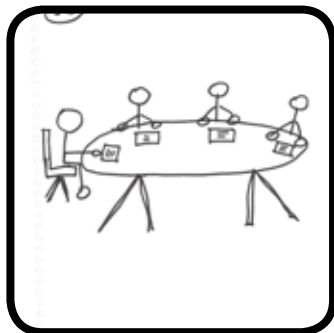

CONCLUSIONES:

CENTRO DE PROMOCIÓN DE AUTONOMÍA PERSONAL - BERGONDO

REFERENTE: SALA POLIVALENTE

GRUPO: PROFESIONALES

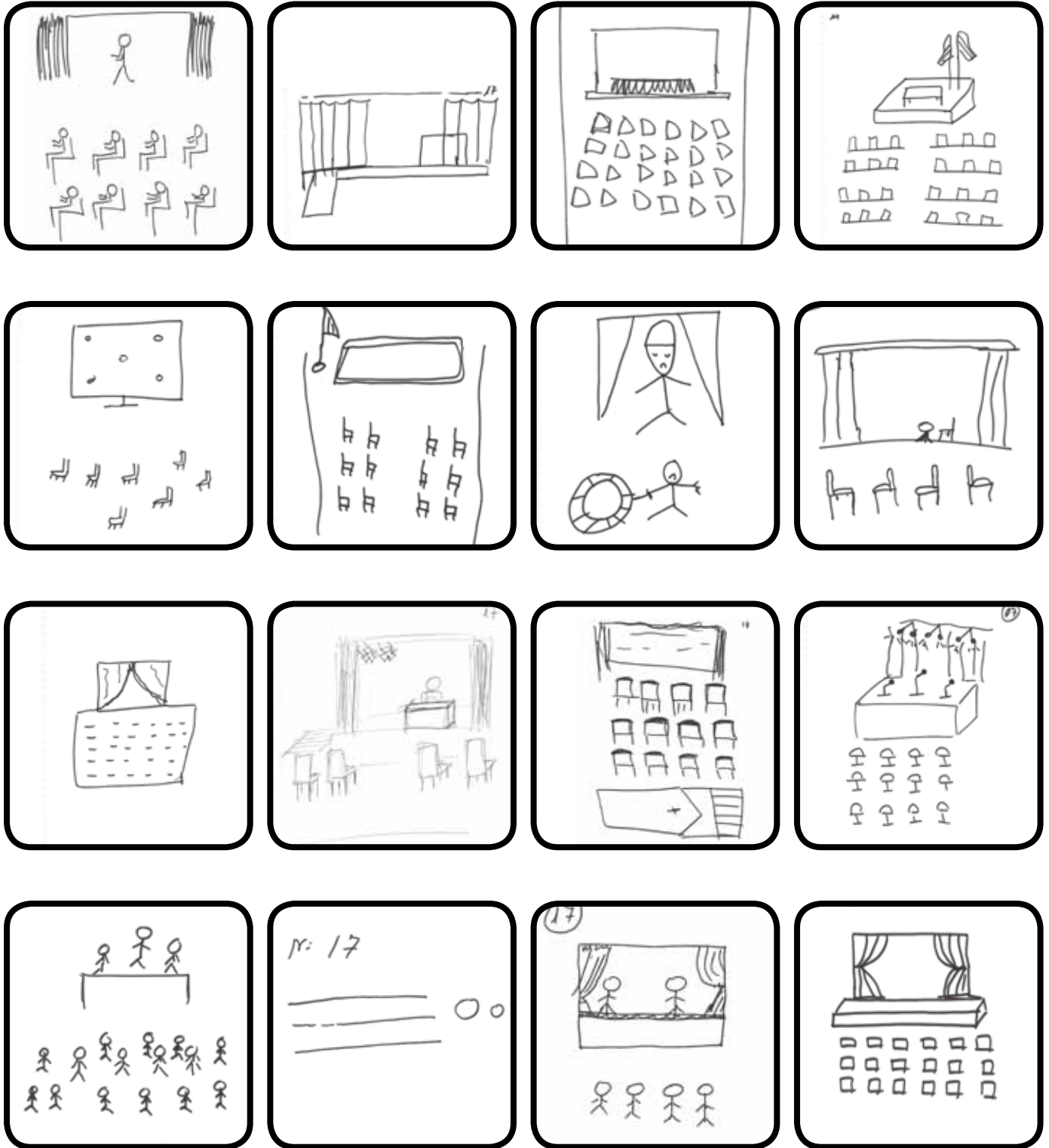

CONCLUSIONES:

CENTRO DE PROMOCIÓN DE AUTONOMÍA PERSONAL - BERGONDO

REFERENTE: SALA DE TERAPIA OCUPACIONAL

GRUPO: PROFESIONALES

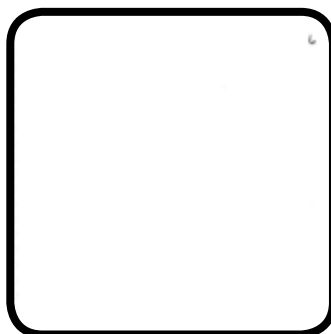
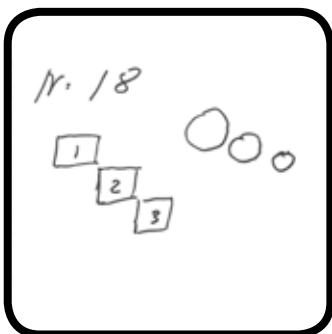
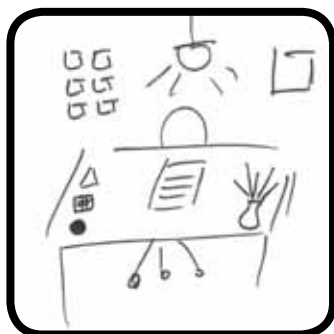
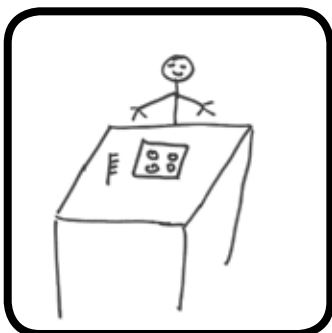
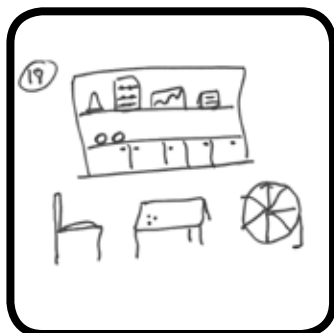
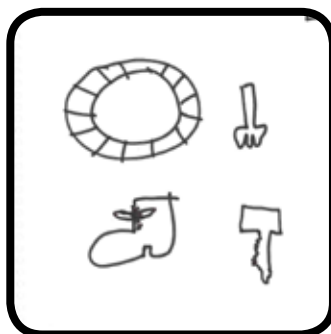
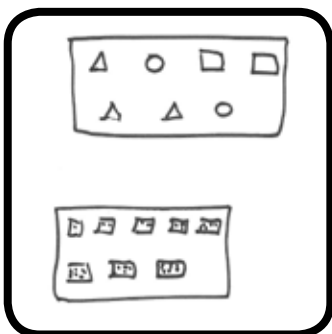
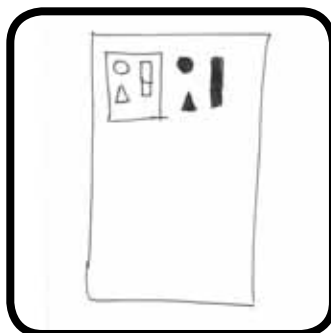
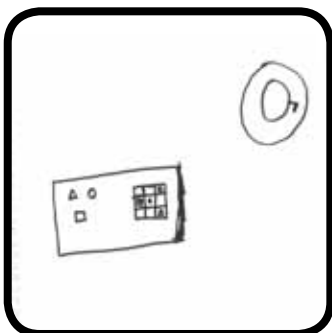

CONCLUSIONES:

CENTRO DE PROMOCIÓN DE AUTONOMÍA PERSONAL - BERGONDO

REFERENTE: TALLER CREATIVO

GRUPO: PROFESIONALES

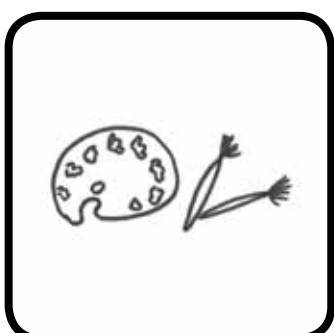
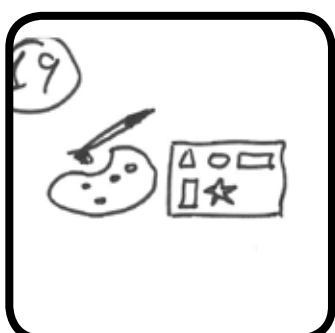
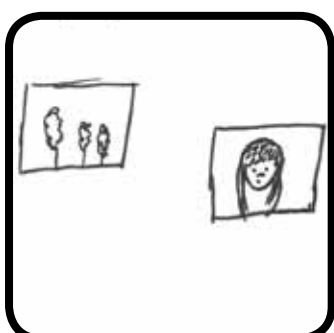
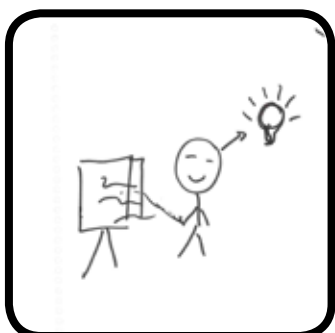
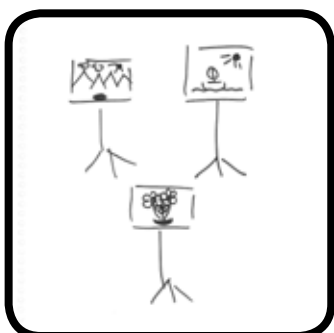
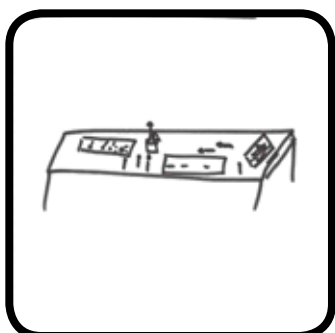
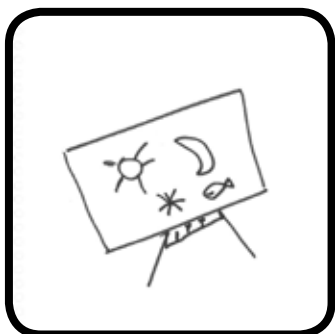
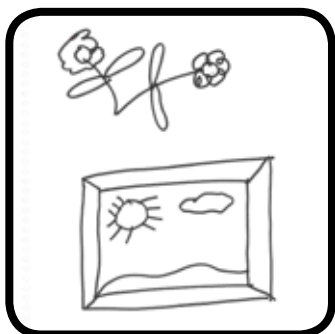
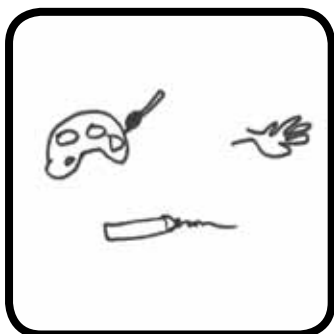
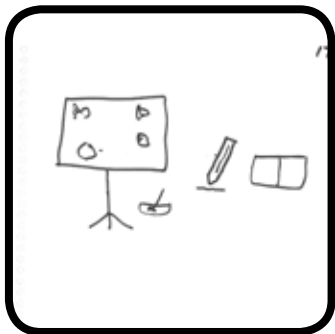
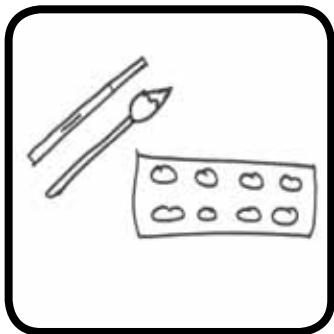
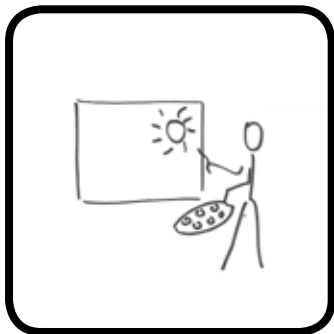

CONCLUSIONES:

CENTRO DE PROMOCIÓN DE AUTONOMÍA PERSONAL - BERGONDO

REFERENTE: **BIBLIOTECA**

GRUPO: PROFESIONALES

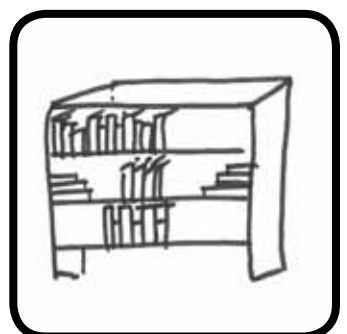
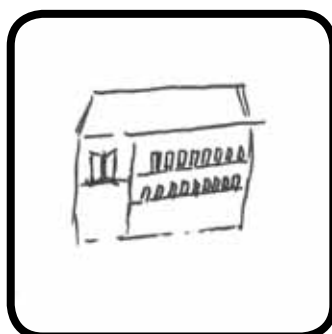
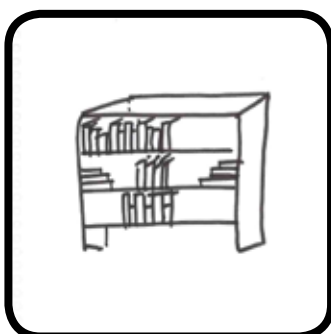
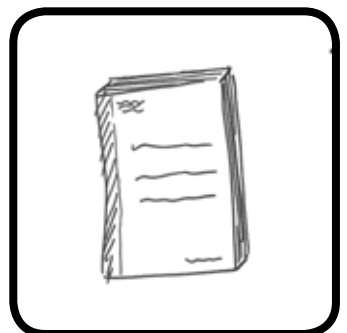
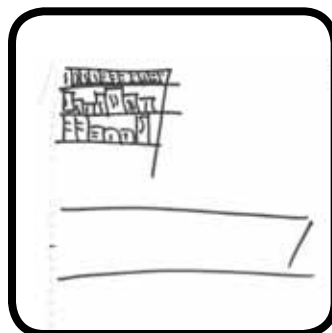
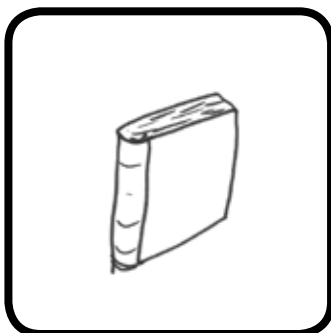
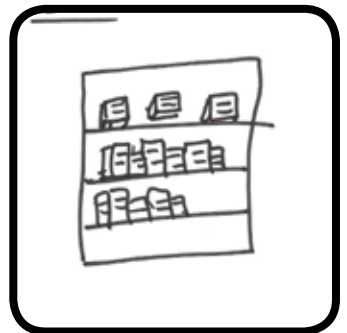
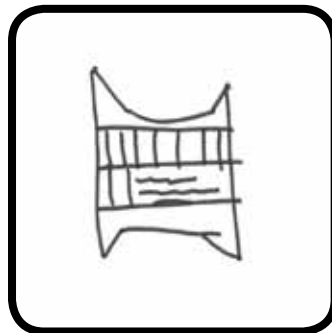
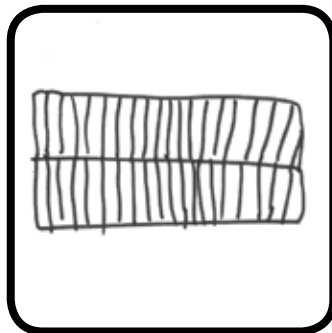
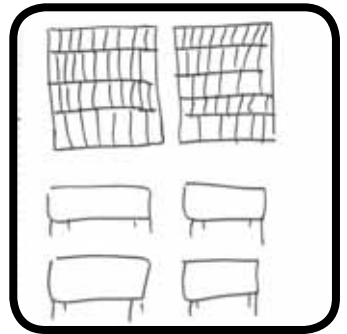
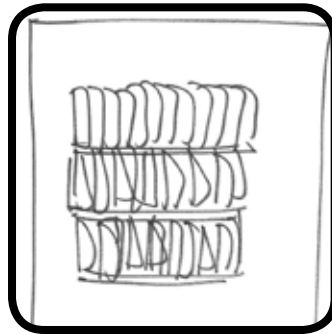
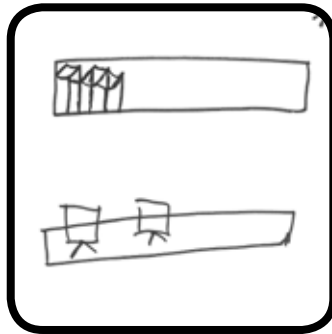
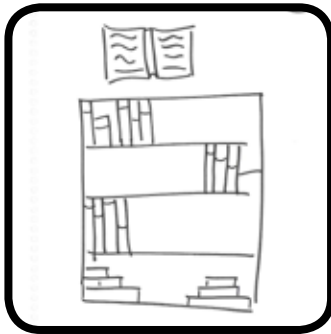

CONCLUSIONES:

CENTRO DE PROMOCIÓN DE AUTONOMÍA PERSONAL - BERGONDO

REFERENTE: CAFETERÍA

GRUPO: PROFESIONALES

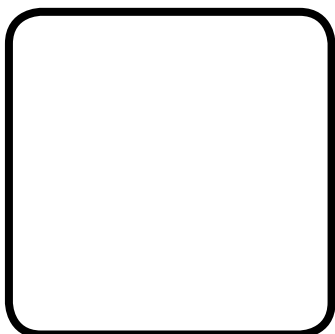
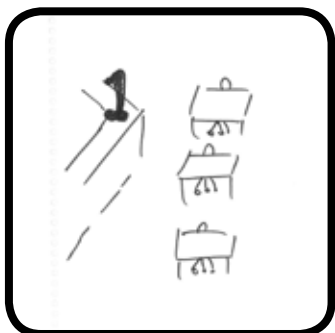
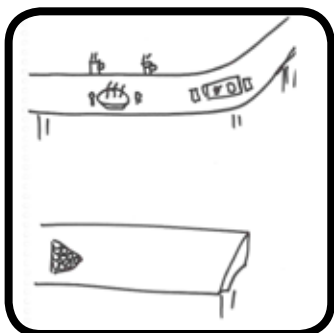
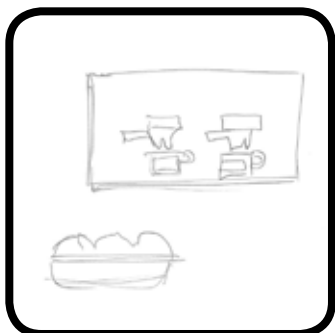
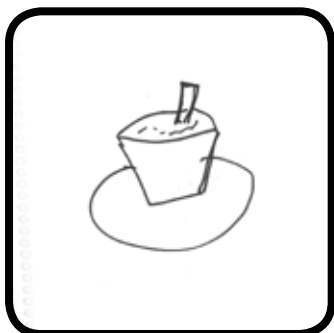
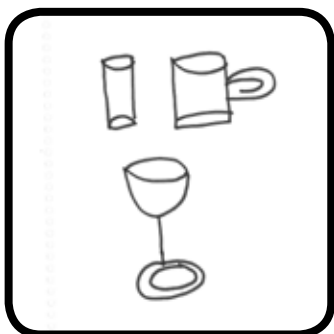
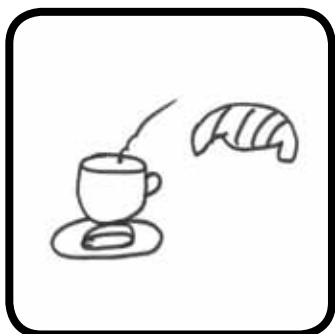
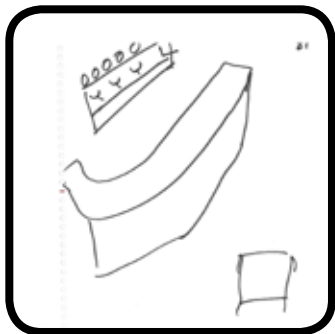
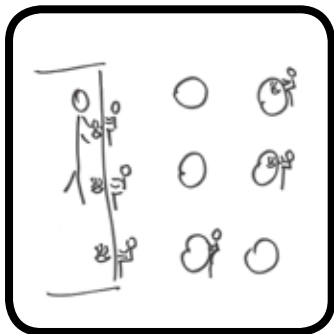

CONCLUSIONES:

CENTRO DE PROMOCIÓN DE AUTONOMÍA PERSONAL - BERGONDO

REFERENTE: **DIRECTOR**

GRUPO: PROFESIONALES

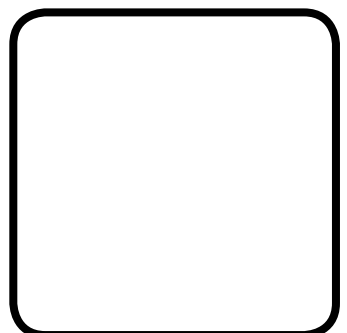
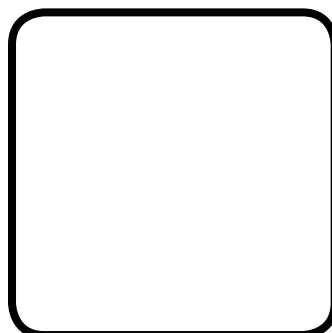
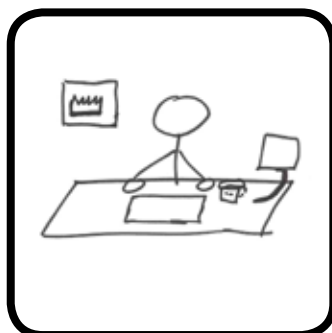
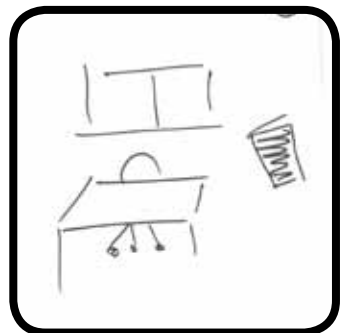
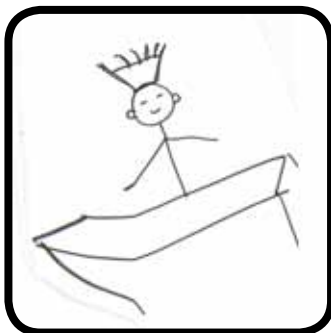
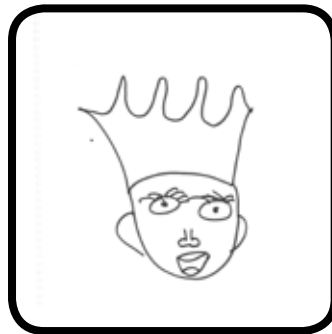
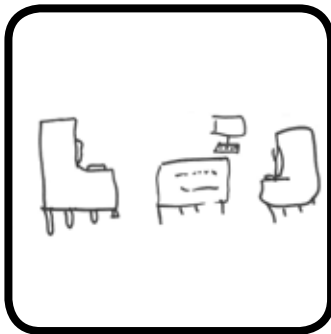
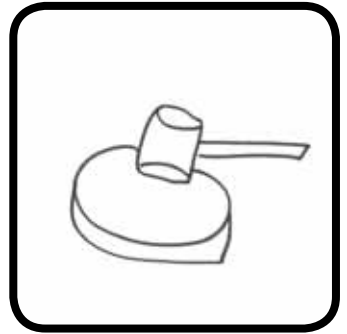
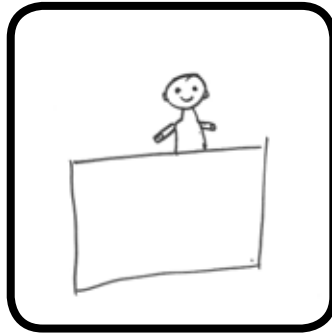

CONCLUSIONES:

CENTRO DE PROMOCIÓN DE AUTONOMÍA PERSONAL - BERGONDO

REFERENTE: DORMITORIO

GRUPO: PROFESIONALES

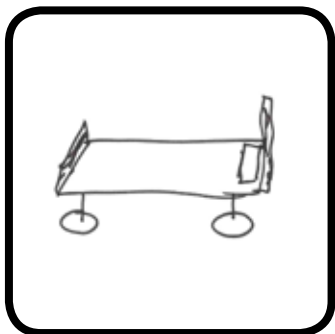
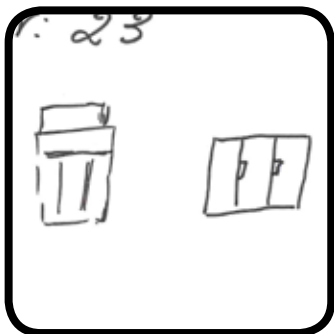
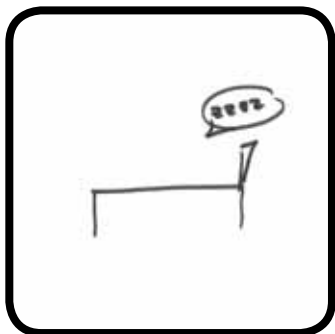
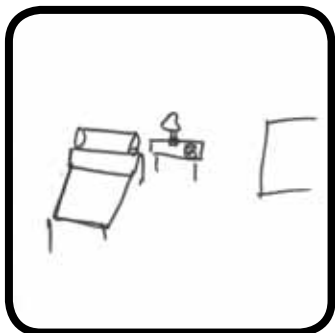
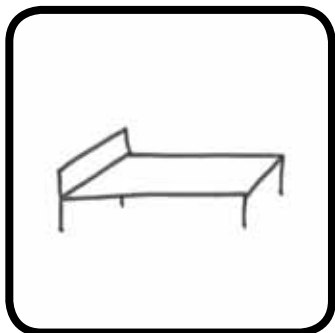
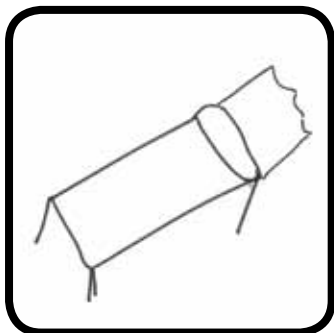
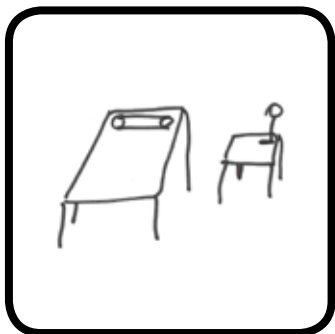
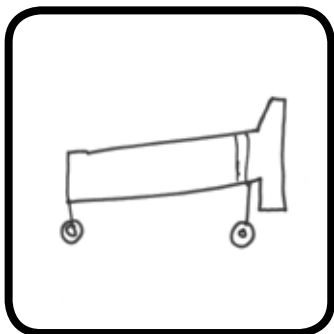
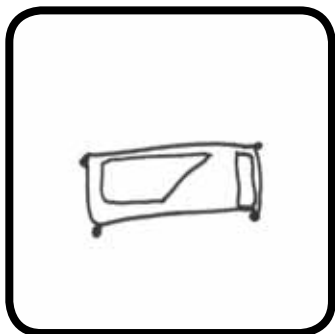
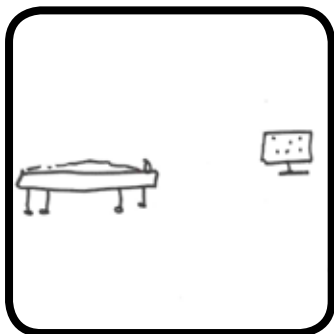
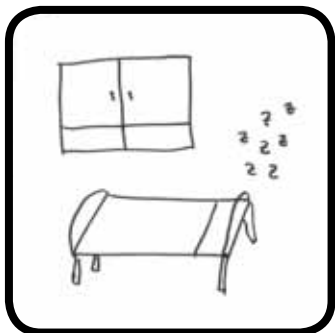
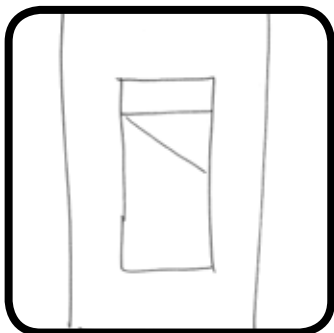
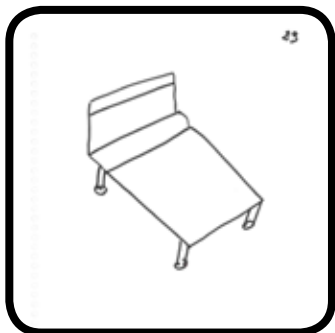
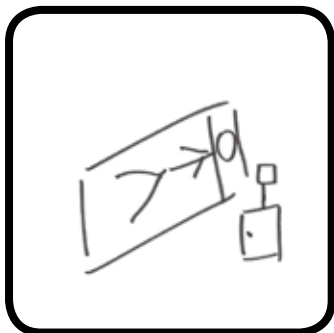

CONCLUSIONES:

CENTRO DE PROMOCIÓN DE AUTONOMÍA PERSONAL - BERGONDO

REFERENTE: **DESPACHO MÉDICO**

GRUPO: PROFESIONALES

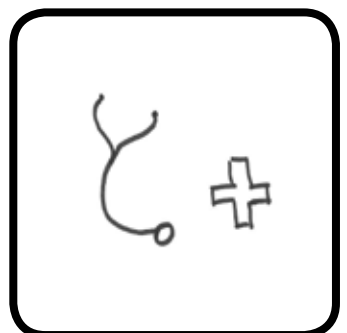
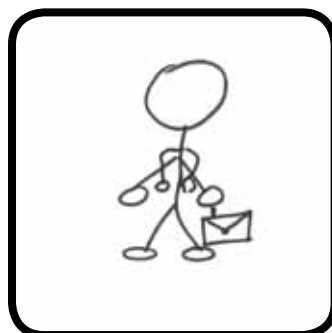
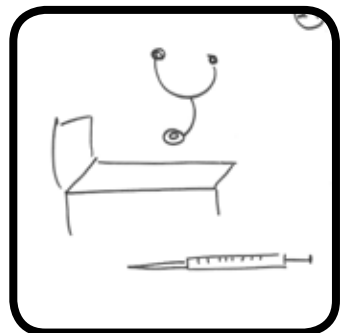
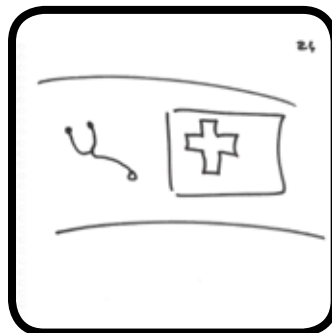
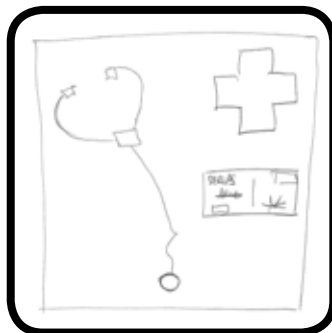
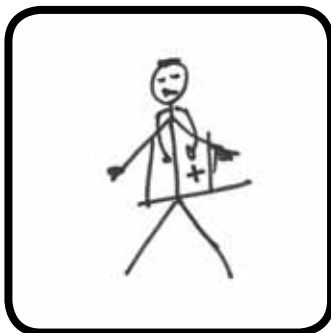
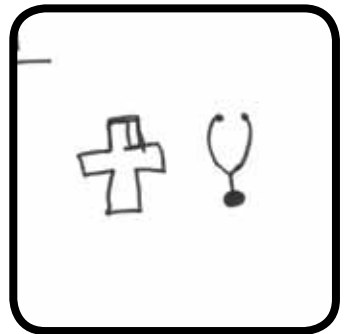
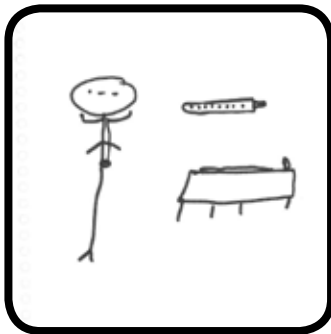
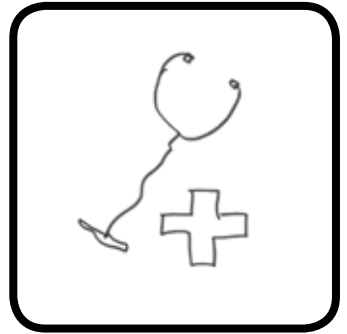
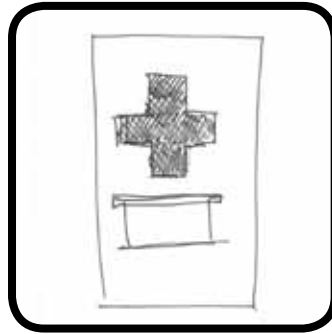
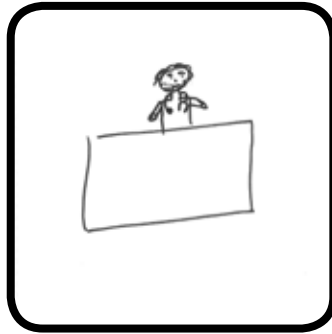

CONCLUSIONES:

CENTRO DE PROMOCIÓN DE AUTONOMÍA PERSONAL - BERGONDO

REFERENTE: RESPONSABLE ÁREA TÉCNICA

GRUPO: PROFESIONALES

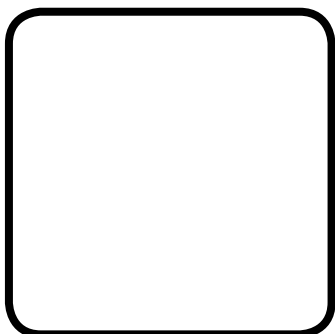
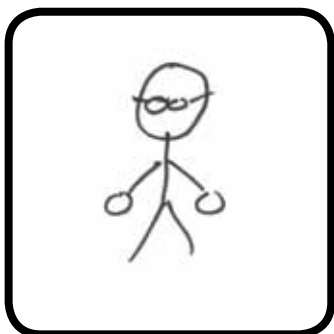
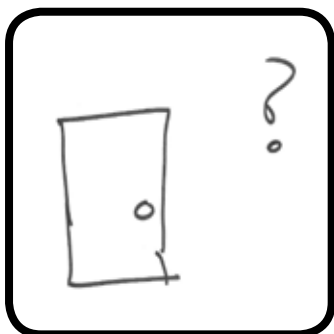
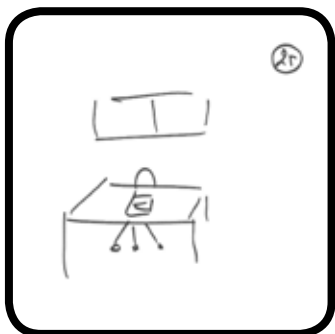
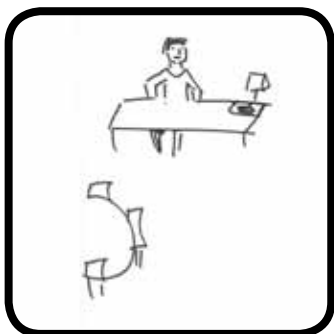
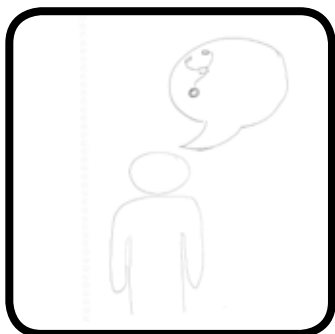
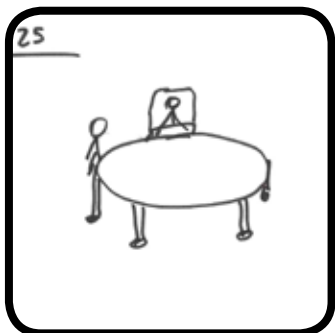
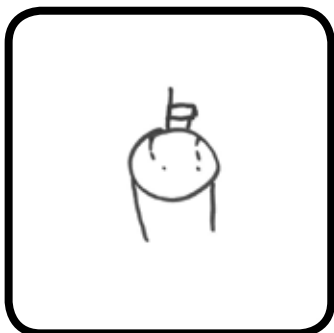
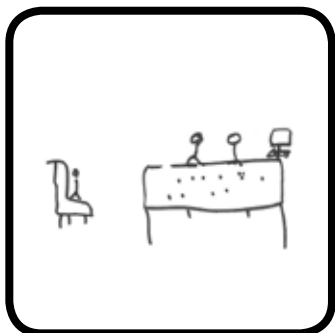
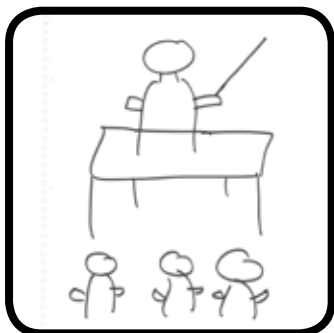
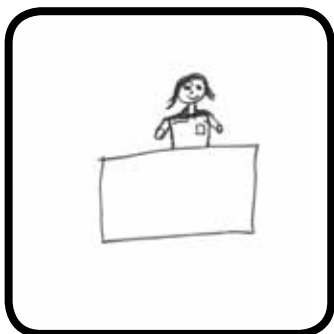
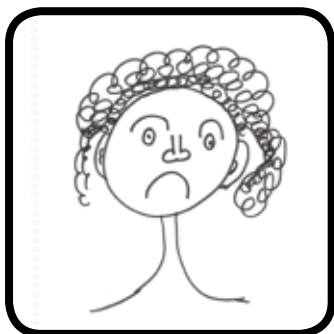

CONCLUSIONES:

CENTRO DE PROMOCIÓN DE AUTONOMÍA PERSONAL - BERGONDO

REFERENTE: DESPACHO DE NEUROPSICÓLOGA

GRUPO: PROFESIONALES

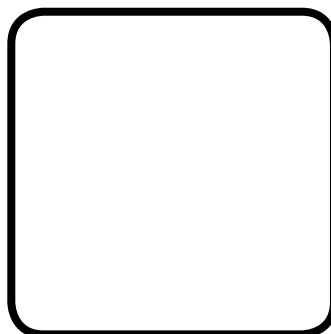
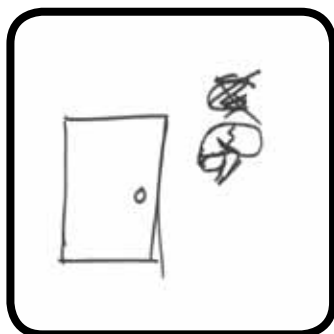
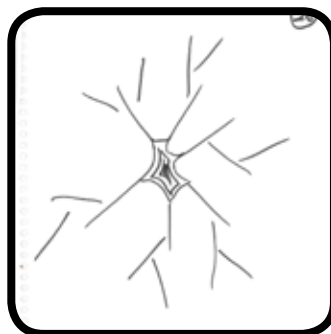
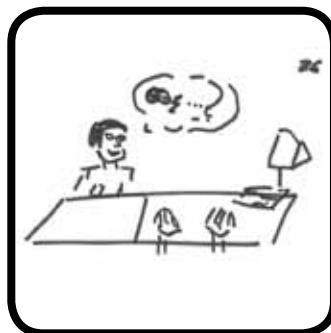
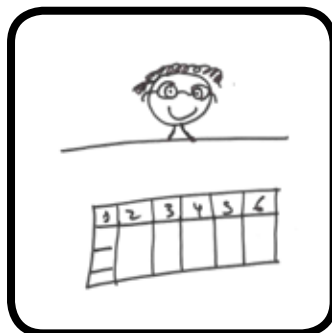
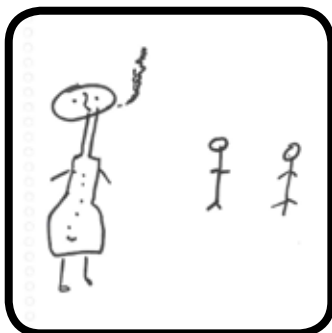
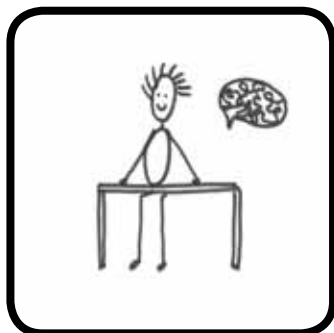
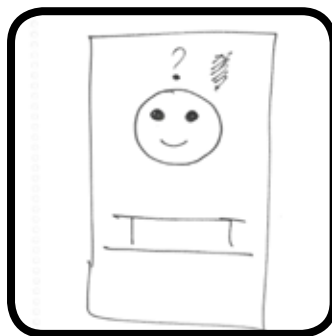
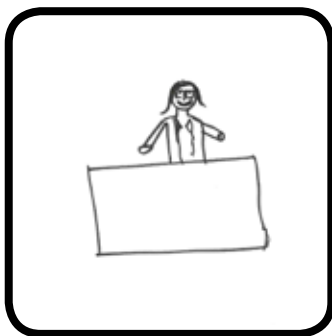

CONCLUSIONES:

CENTRO DE PROMOCIÓN DE AUTONOMÍA PERSONAL - BERGONDO

REFERENTE: DESPACHO MÉDICO REHABILITADOR

GRUPO: PROFESIONALES

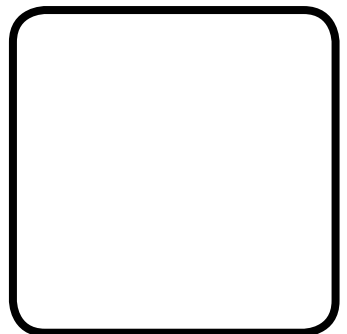
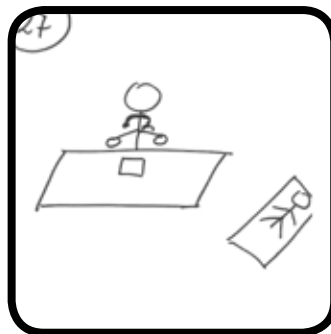
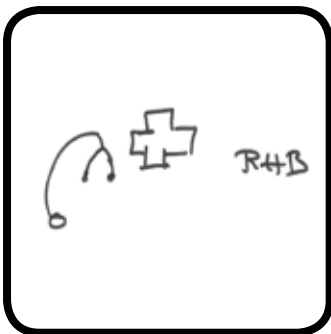
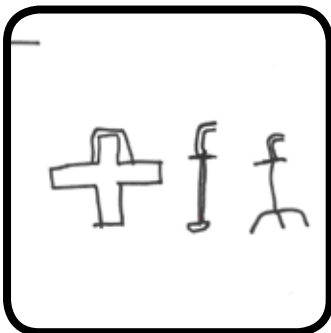
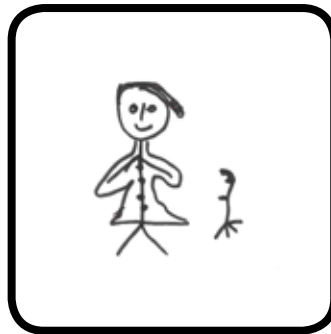
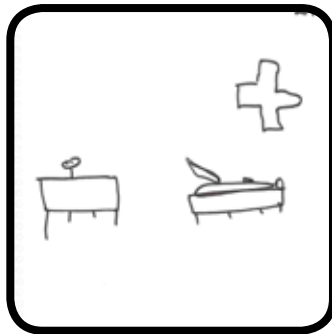
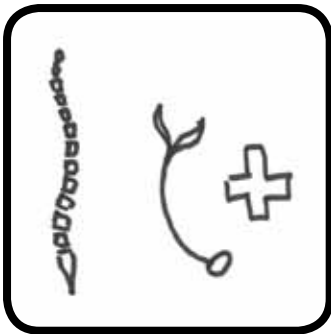
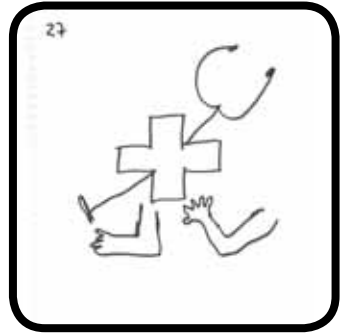
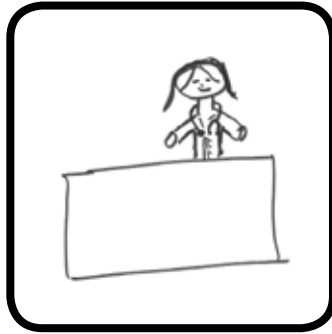

CONCLUSIONES:

CENTRO DE PROMOCIÓN DE AUTONOMÍA PERSONAL - BERGONDO

REFERENTE: VIVIENDA ADAPTADA

GRUPO: PROFESIONALES

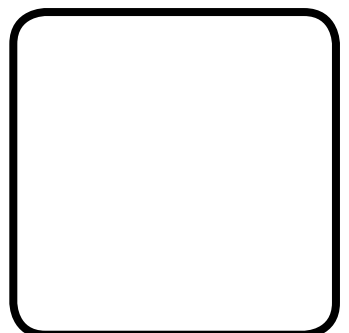
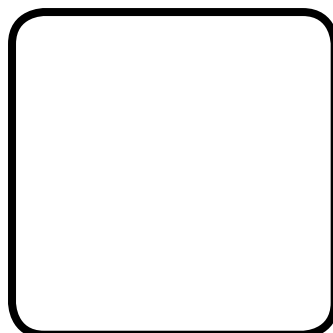
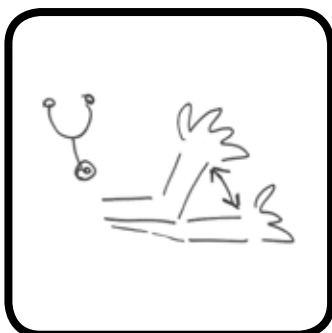
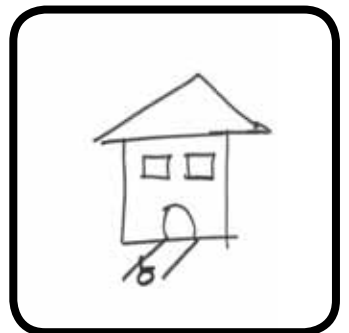
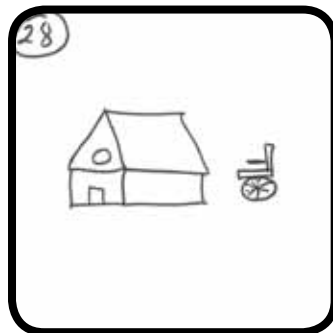
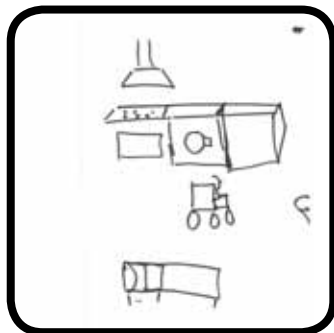
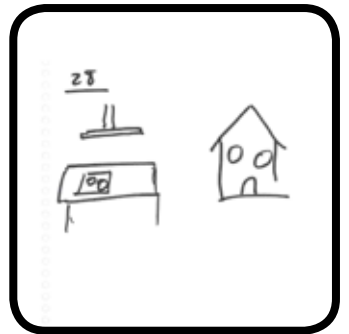
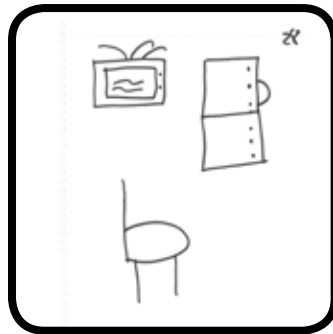
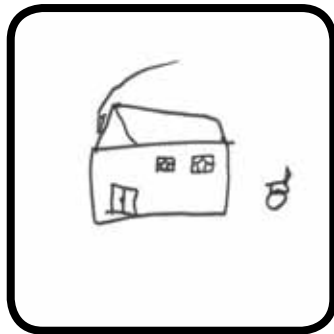
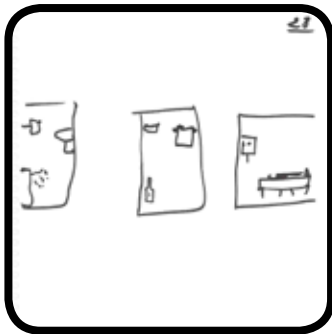
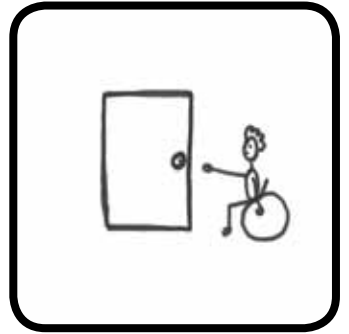
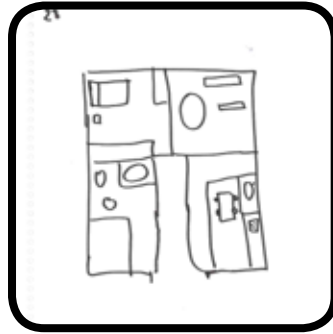
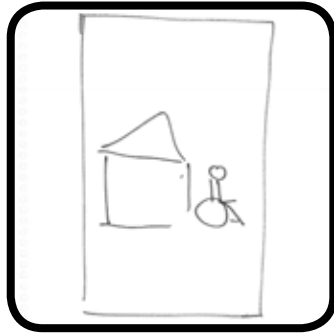
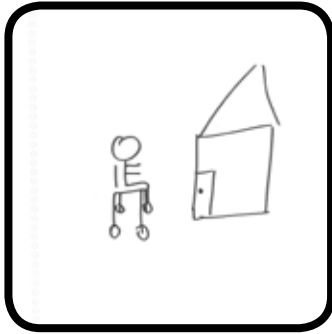

CONCLUSIONES:

CENTRO DE PROMOCIÓN DE AUTONOMÍA PERSONAL - BERGONDO

REFERENTE: TALLER ACTIVIDADES VIDA DIARIA

GRUPO: PROFESIONALES

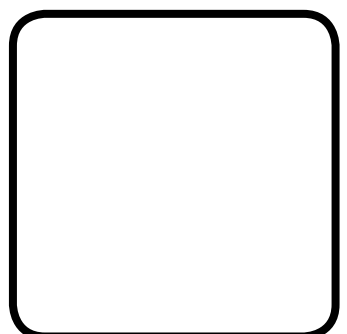
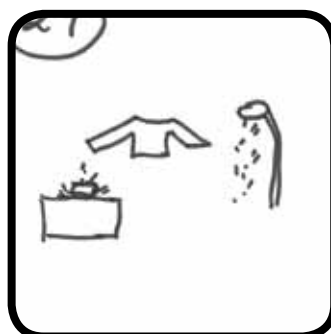
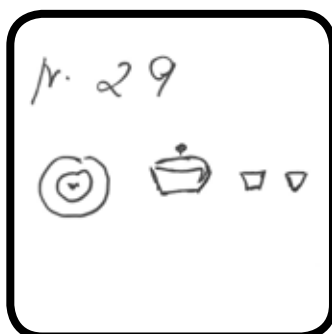
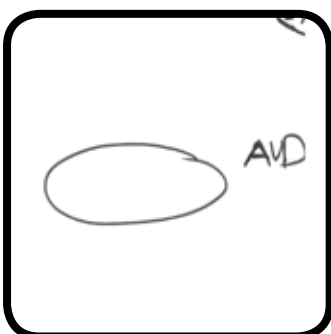
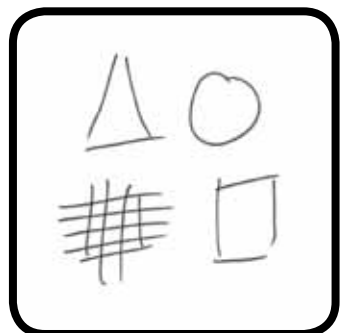
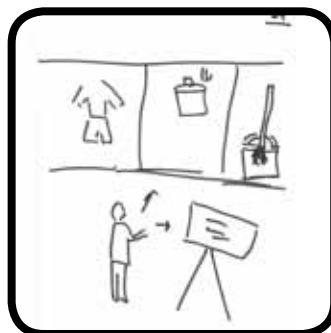
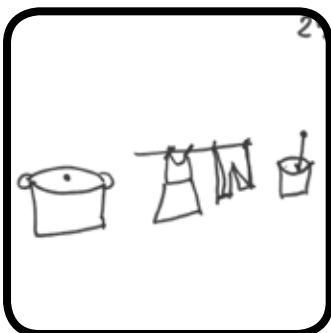
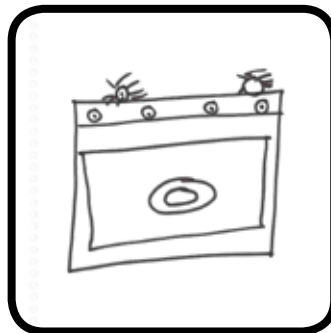
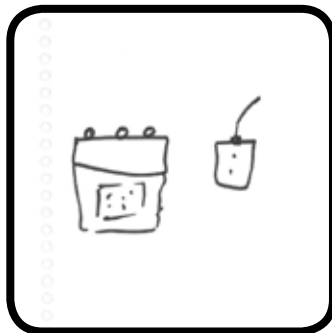
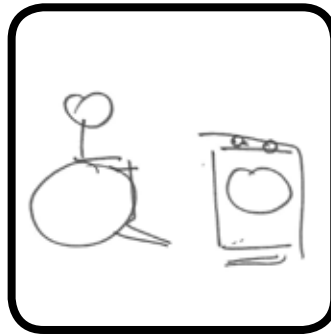
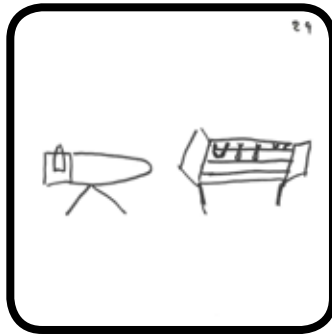
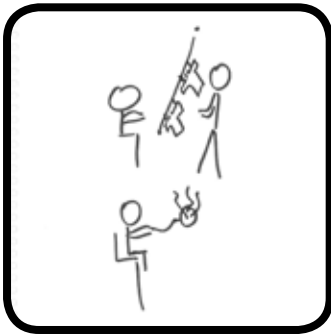

CONCLUSIONES:

CENTRO DE PROMOCIÓN DE AUTONOMÍA PERSONAL - BERGONDO

REFERENTE:
SALA DE EXPOSICIÓN DE PRODUCTOS DE APOYO

GRUPO: PROFESIONALES

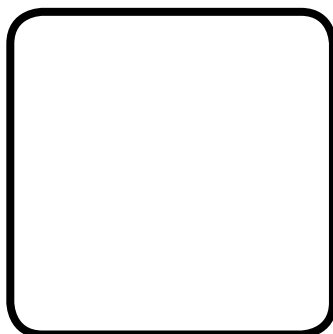
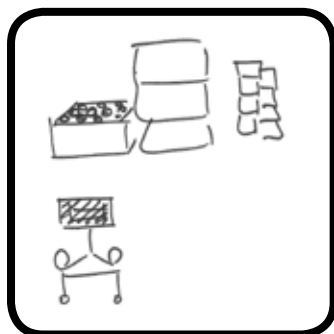
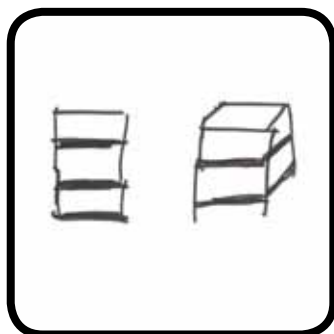
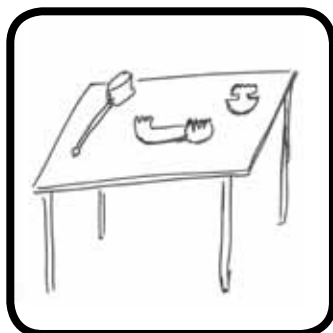
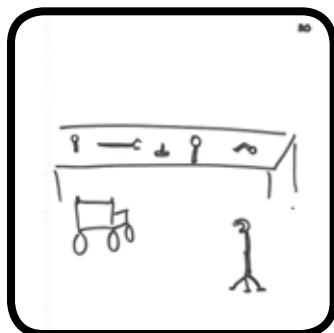
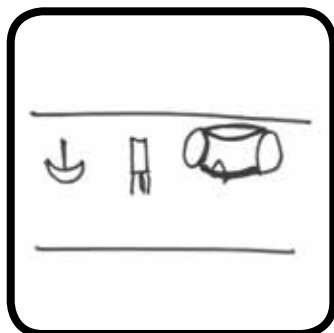
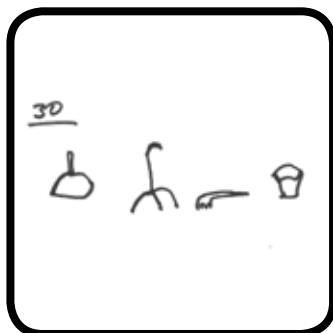
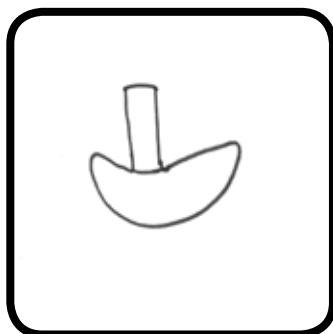
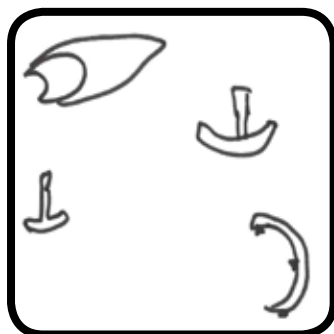
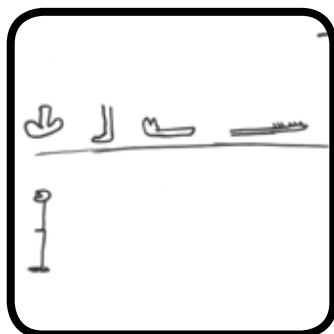
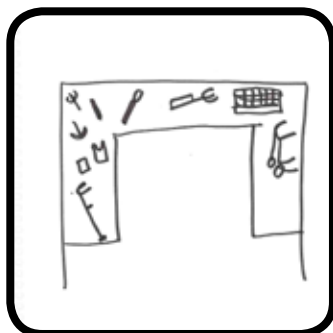
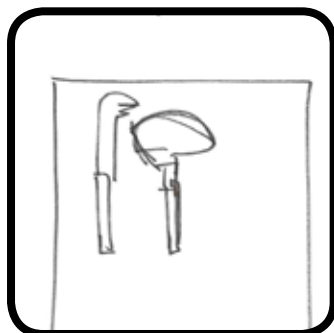
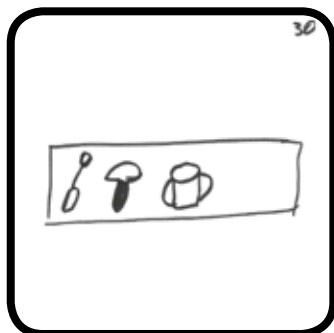
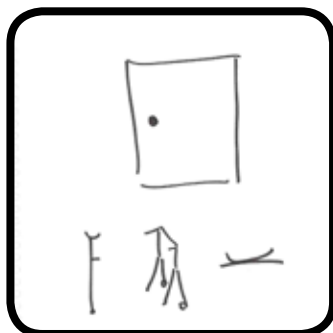

CONCLUSIONES:

CENTRO DE PROMOCIÓN DE AUTONOMÍA PERSONAL - BERGONDO

REFERENTE: ALMACÉN

GRUPO: PROFESIONALES

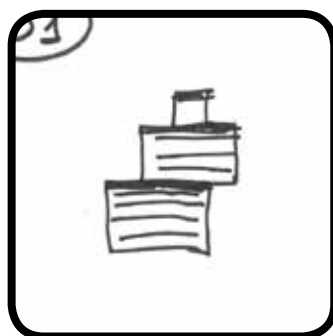
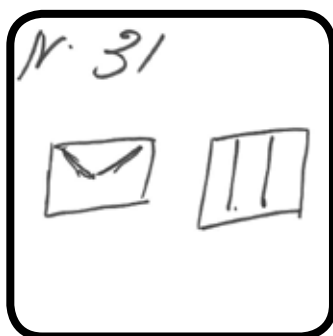
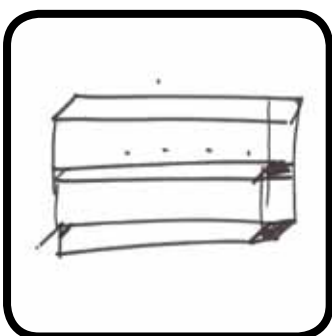
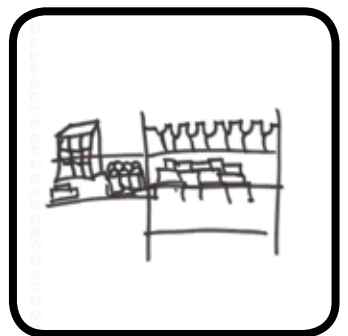
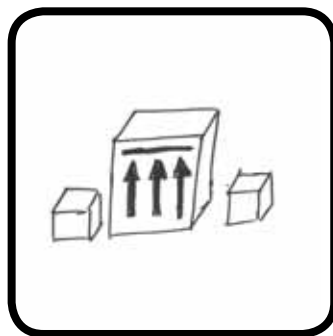
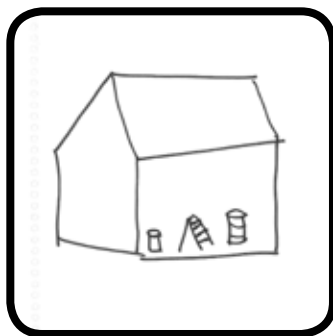
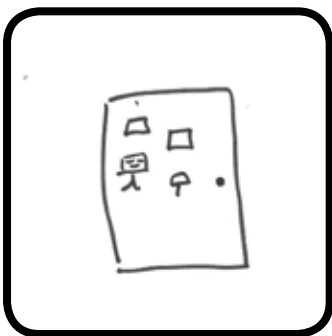
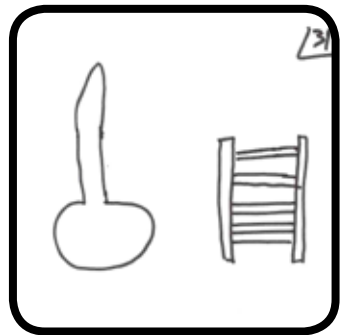
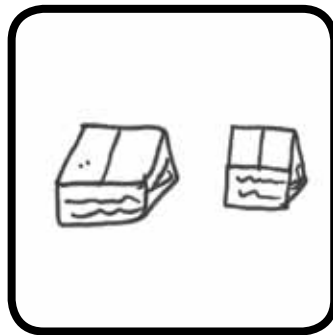
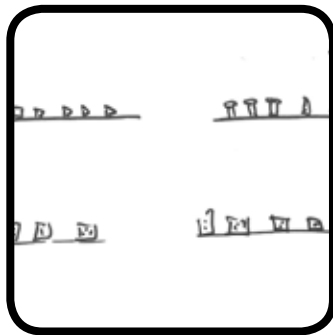
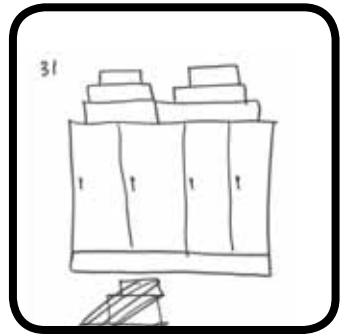
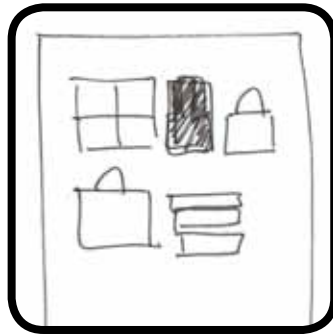
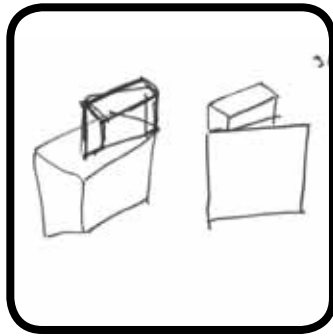

CONCLUSIONES:

CENTRO DE PROMOCIÓN DE AUTONOMÍA PERSONAL - BERGONDO

REFERENTE: COMEDOR EMPLEADOS

GRUPO: PROFESIONALES

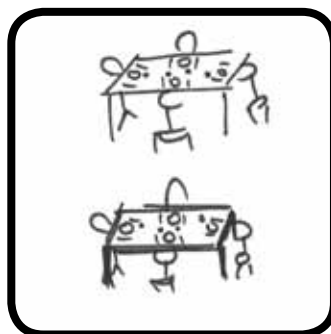
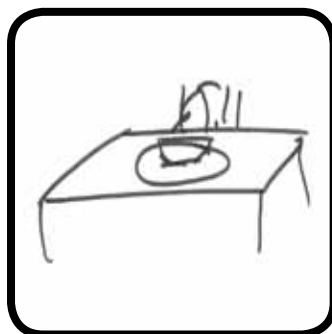
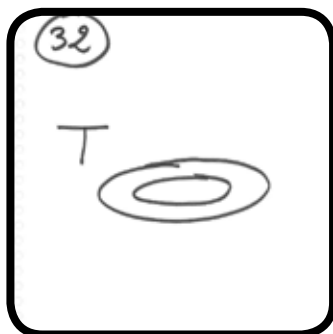
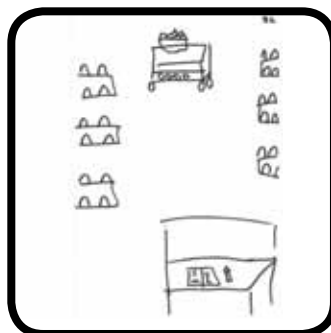
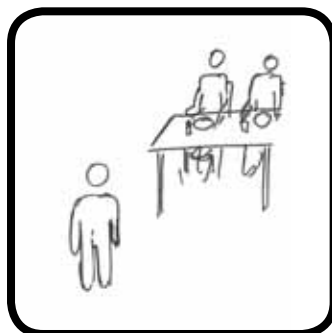
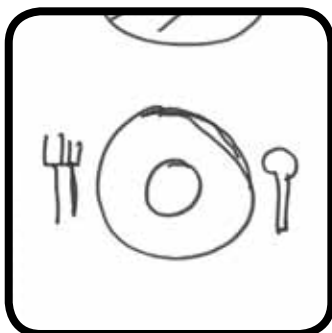
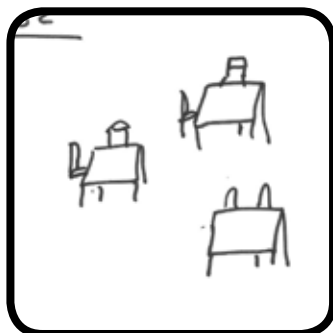
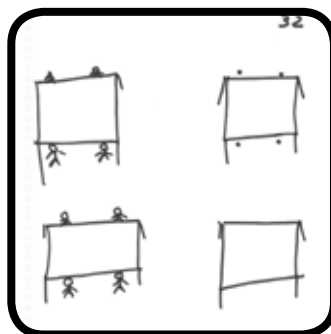
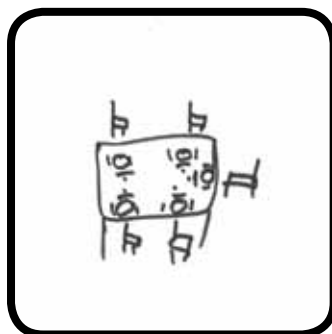
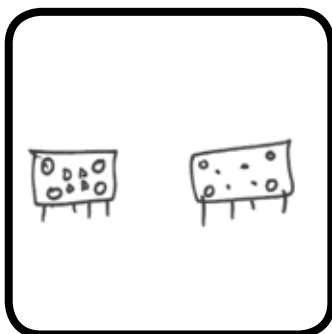
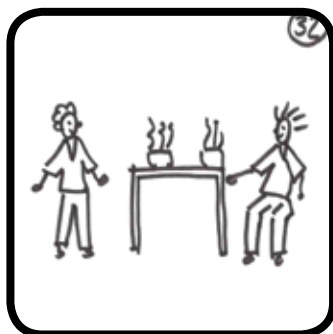
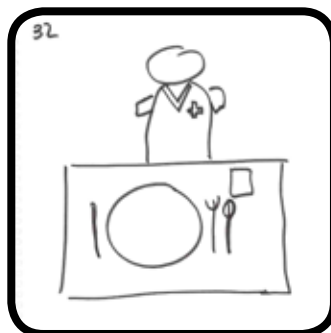
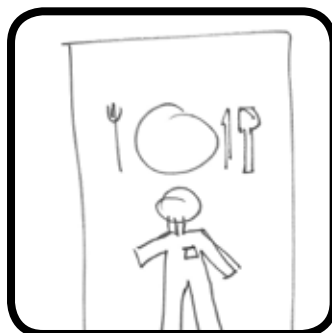
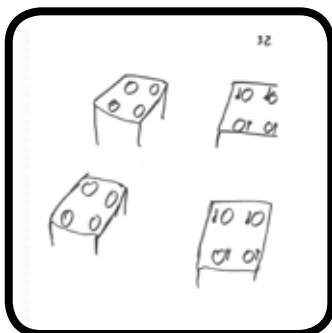
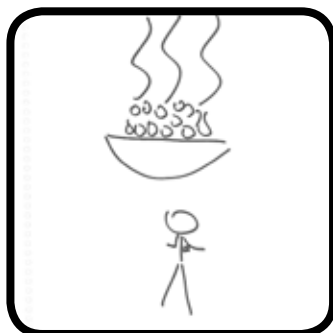

CONCLUSIONES:

CENTRO DE PROMOCIÓN DE AUTONOMÍA PERSONAL - BERGONDO

REFERENTE: DESPACHO DE ADMINISTRACIÓN

GRUPO: PROFESIONALES

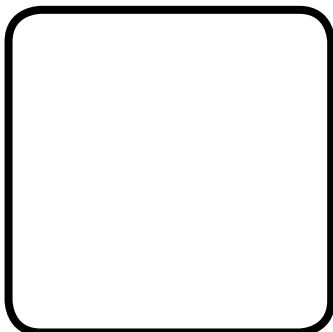
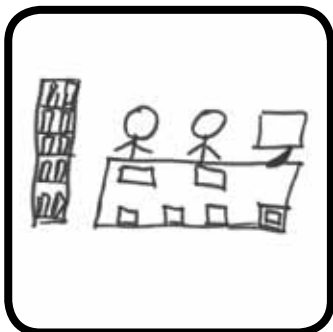
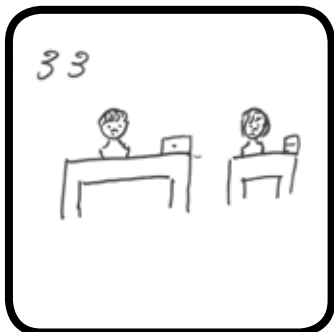
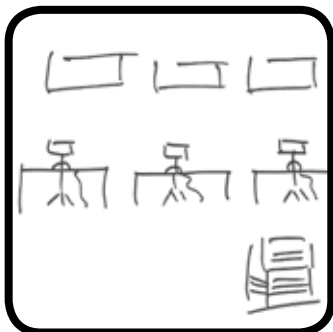
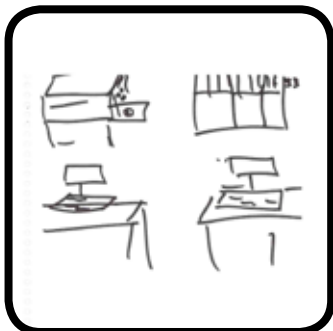
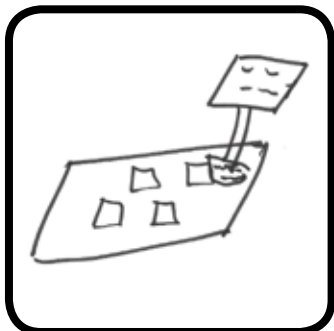
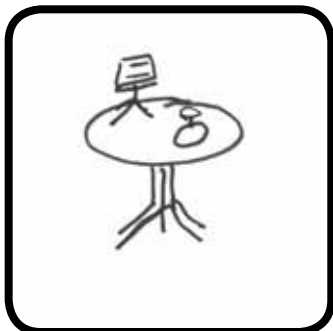
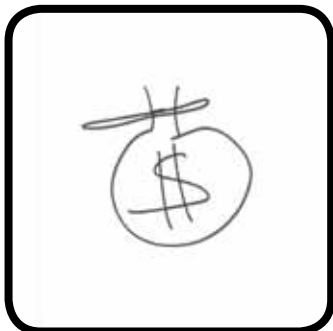
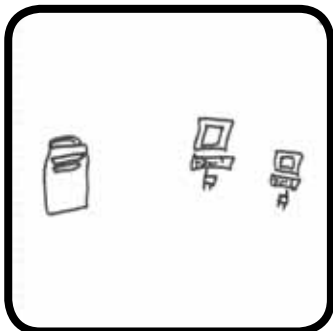
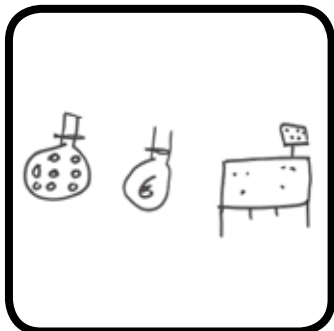
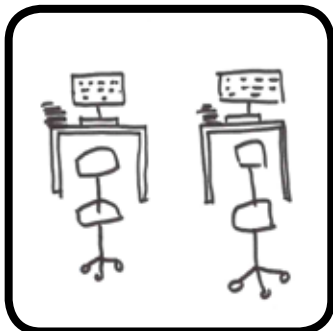
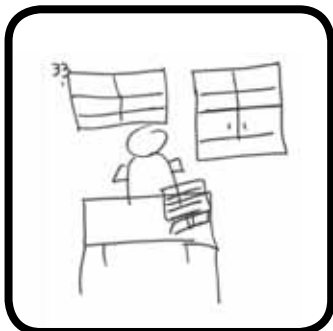
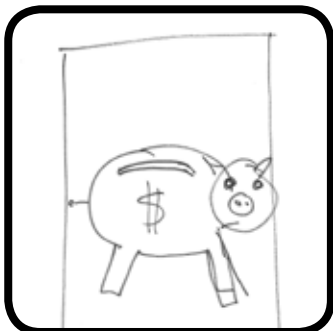
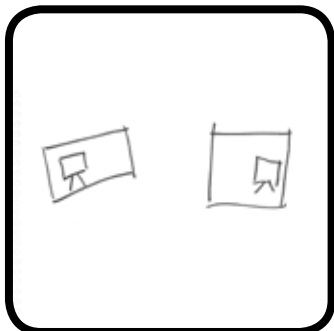
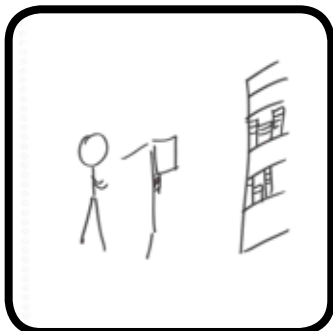

CONCLUSIONES:

CENTRO DE PROMOCIÓN DE AUTONOMÍA PERSONAL - BERGONDO

REFERENTE: **DESPACHO GOBERNANTÍA**

GRUPO: PROFESIONALES

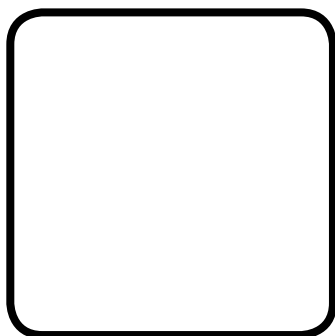
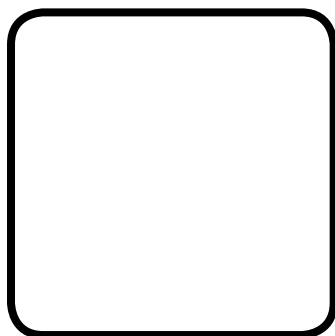
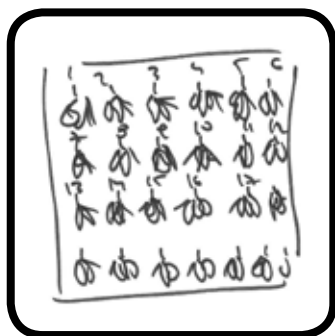
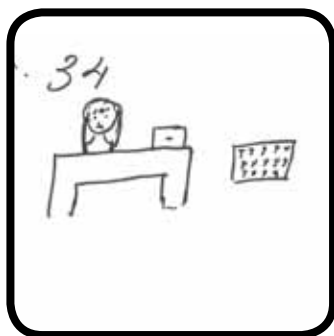
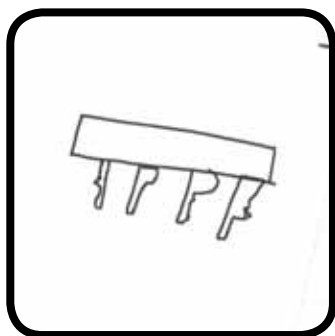
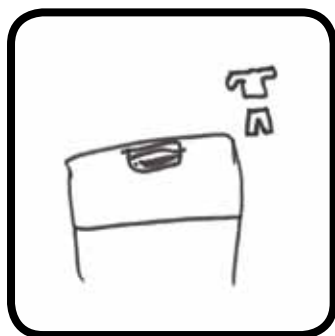
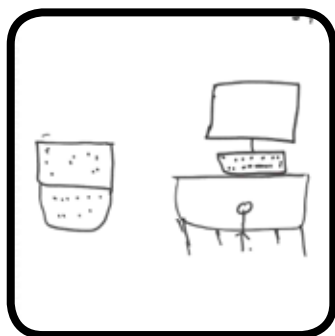
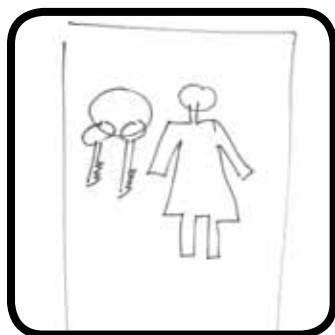
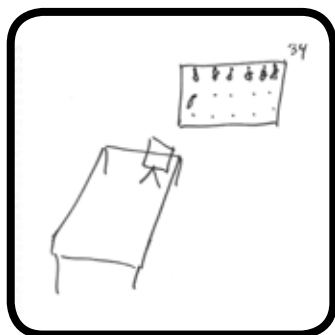
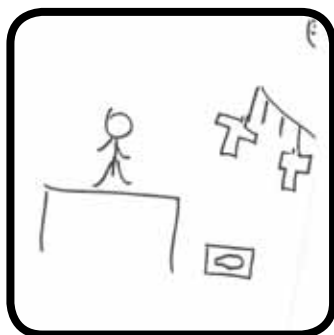

CONCLUSIONES:

CENTRO DE PROMOCIÓN DE AUTONOMÍA PERSONAL - BERGONDO

REFERENTE: DESPACHO JEFE DE ALMACÉN

GRUPO: PROFESIONALES

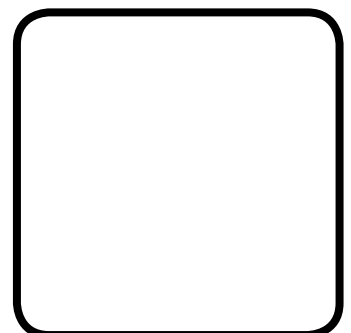
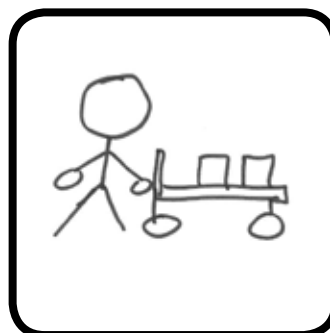
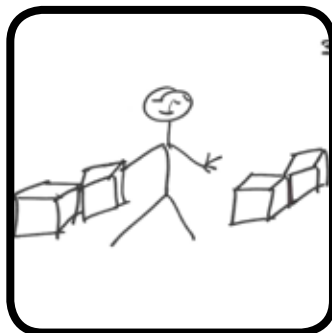
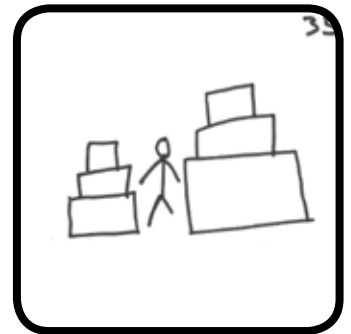
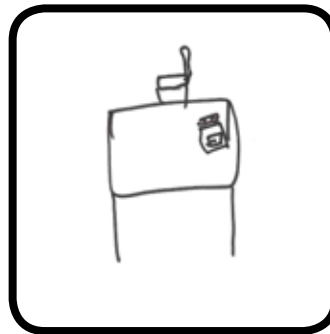
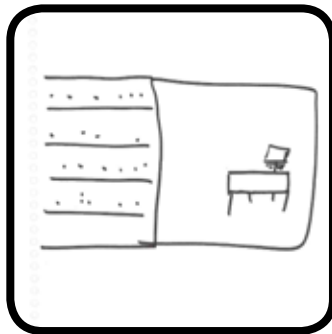
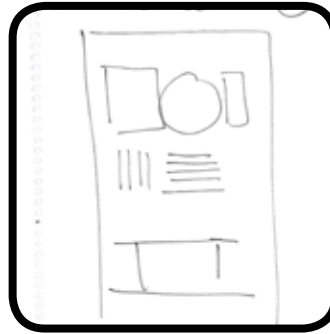
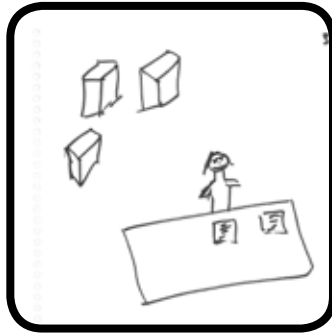

CONCLUSIONES:

CENTRO DE PROMOCIÓN DE AUTONOMÍA PERSONAL - BERGONDO

REFERENTE: **LAVANDERÍA**

GRUPO: PROFESIONALES

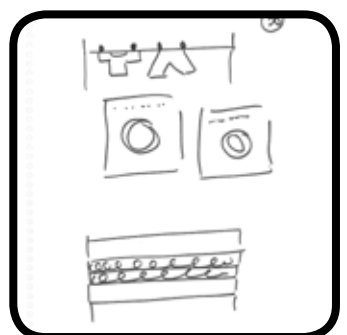
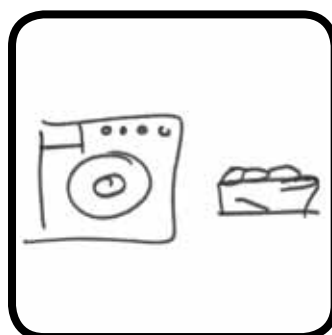
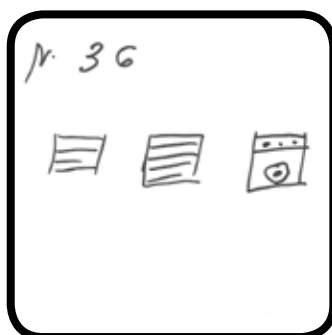
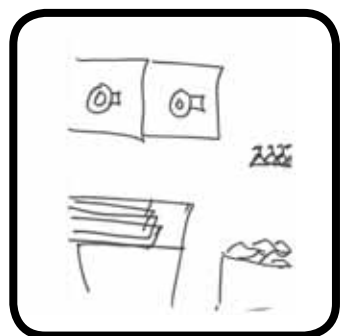
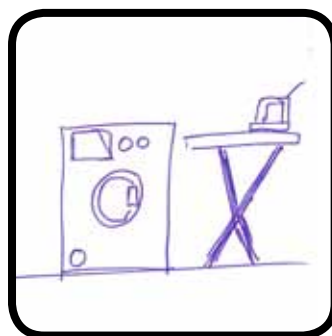
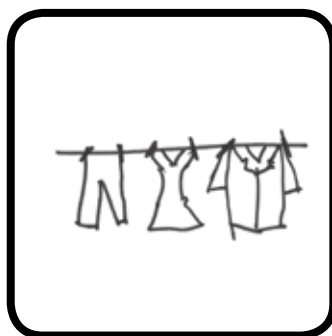
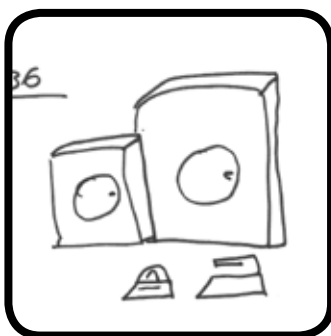
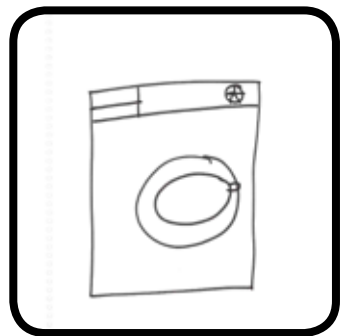
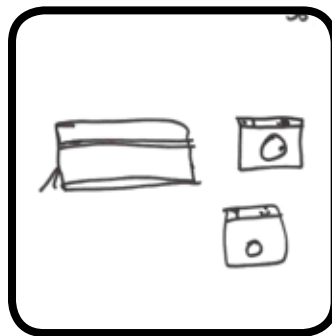
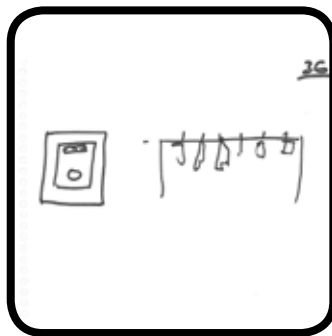
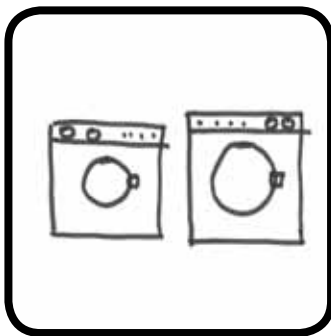
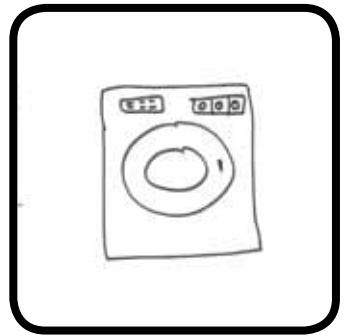
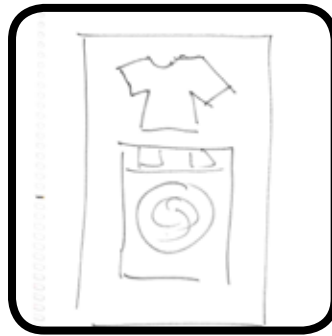
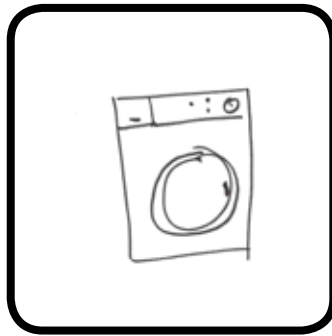
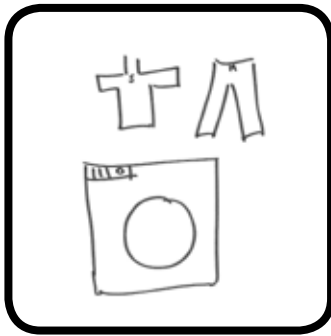

CONCLUSIONES:

CENTRO DE PROMOCIÓN DE AUTONOMÍA PERSONAL - BERGONDO

REFERENTE: MANTENIMIENTO

GRUPO: PROFESIONALES

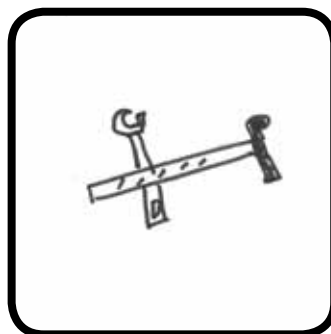
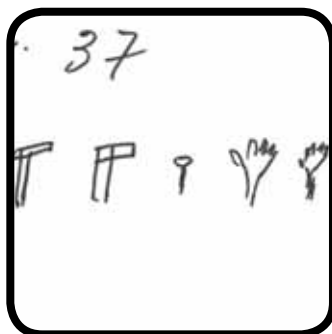
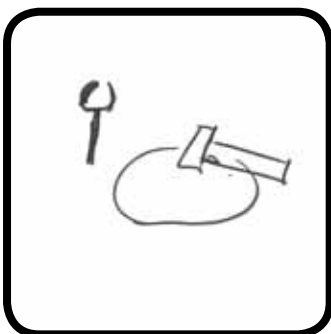
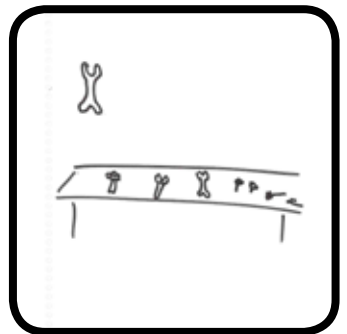
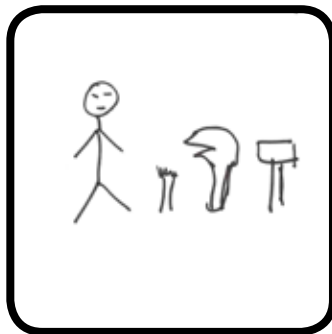
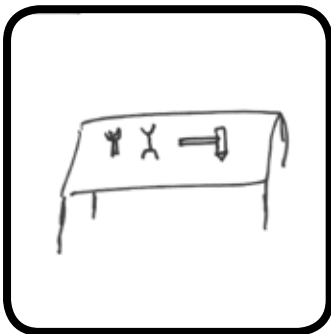
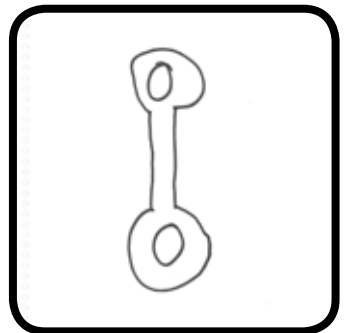
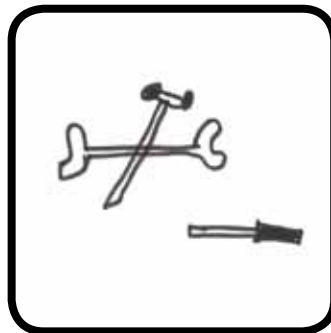
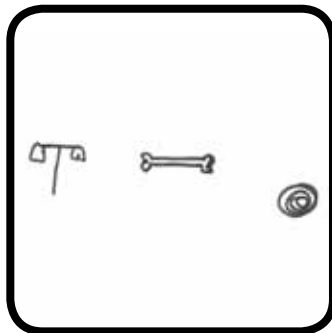
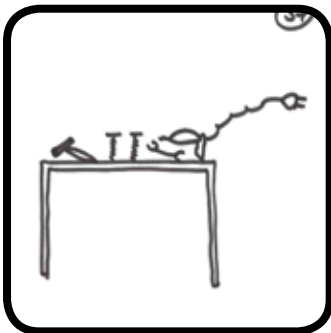
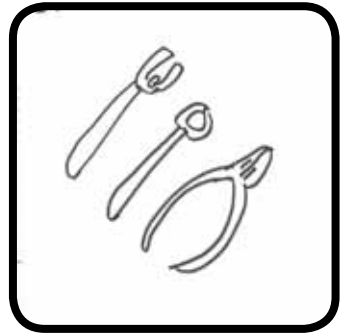
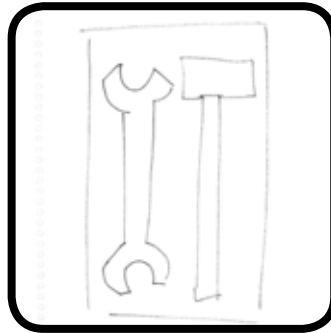
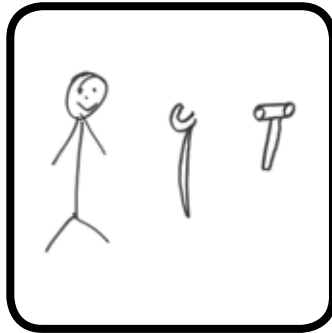
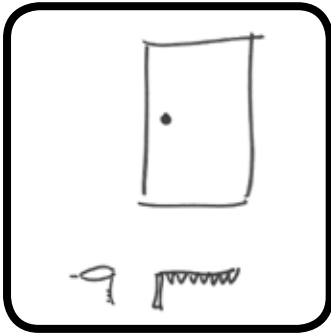

CONCLUSIONES:

CENTRO DE PROMOCIÓN DE AUTONOMÍA PERSONAL - BERGONDO

REFERENTE: **COCINA**

GRUPO: PROFESIONALES

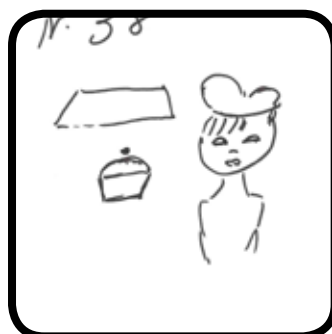
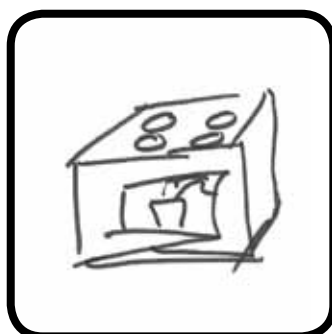
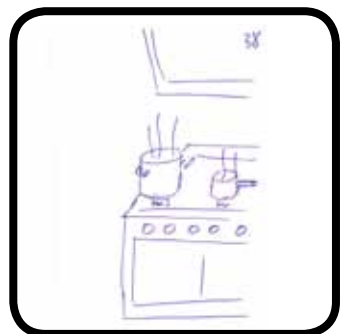
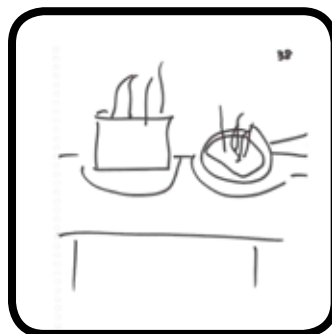
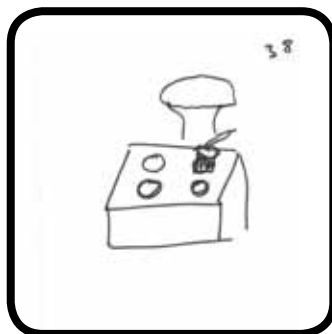
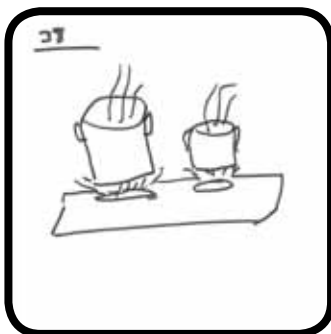
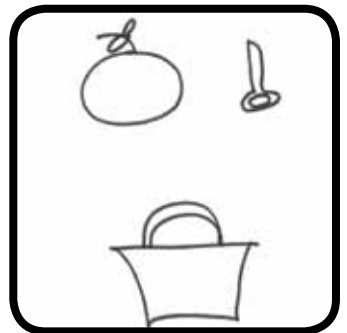
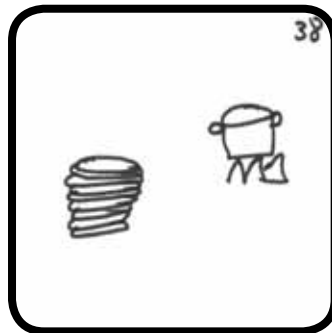
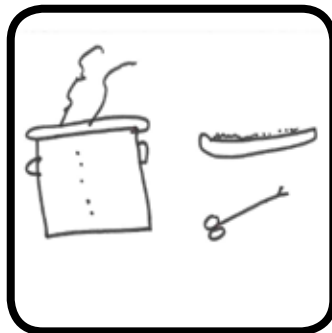
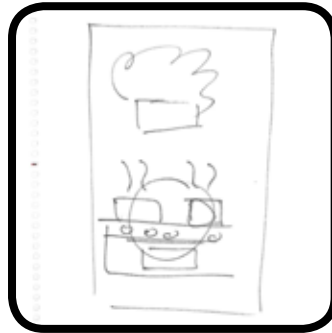
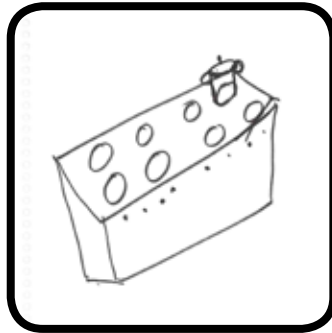

CONCLUSIONES:

CENTRO DE PROMOCIÓN DE AUTONOMÍA PERSONAL - BERGONDO

REFERENTE: VESTUARIO FEMENINO

GRUPO: PROFESIONALES

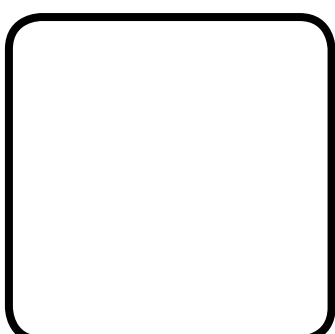
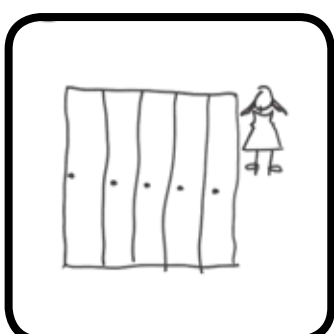
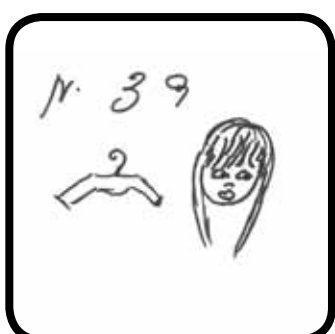
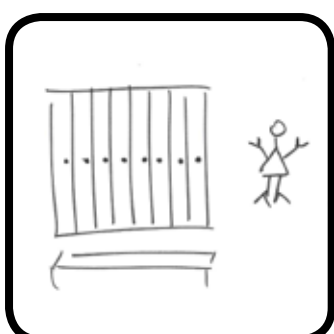
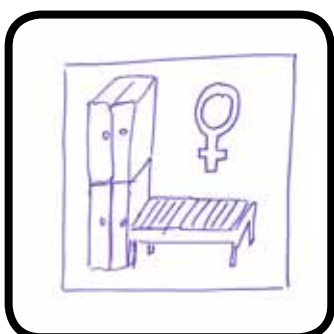
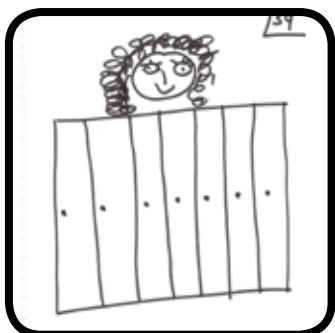
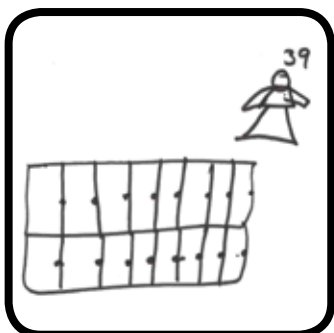
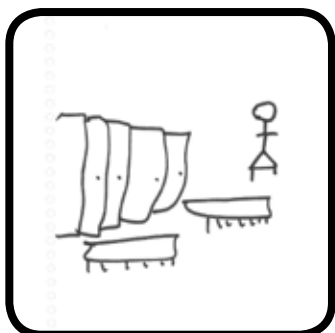
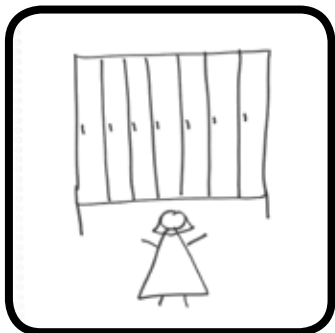
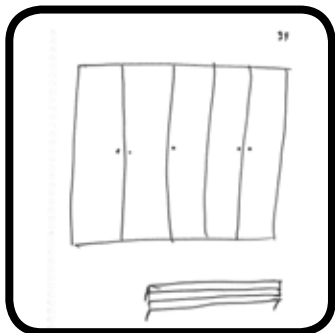
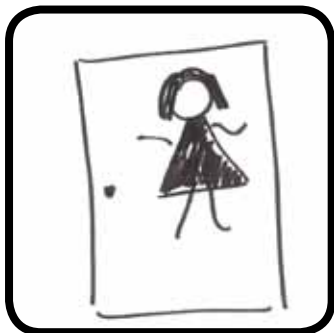

CONCLUSIONES:

CENTRO DE PROMOCIÓN DE AUTONOMÍA PERSONAL - BERGONDO

REFERENTE: VESTUARIO MASCULINO

GRUPO: PROFESIONALES

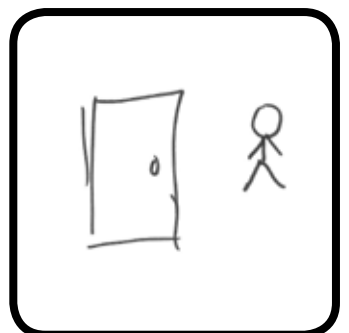
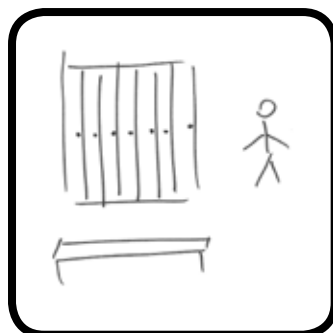
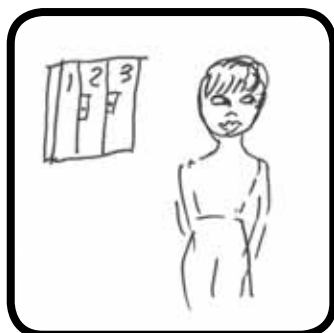
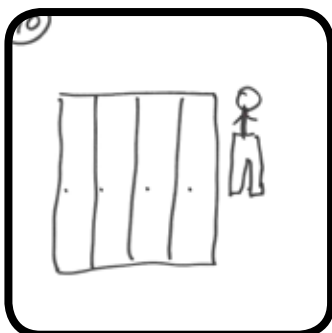
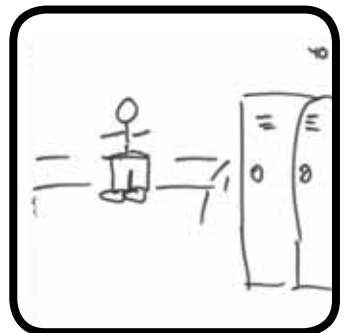
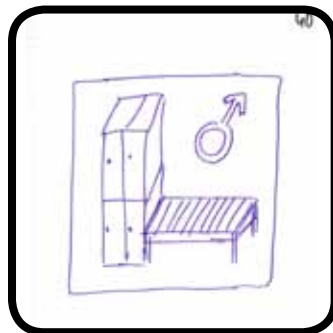
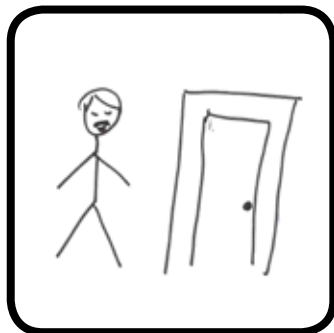
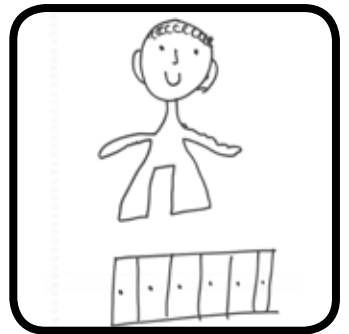
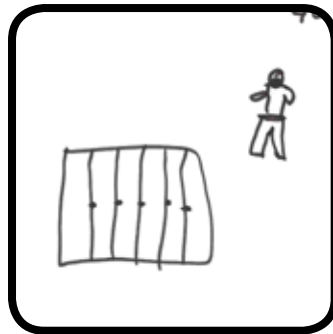
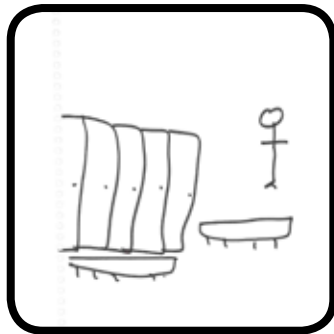
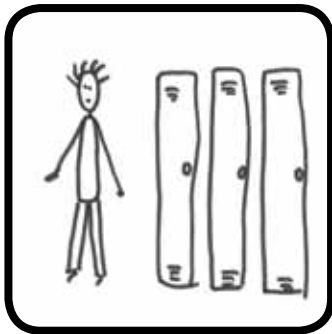
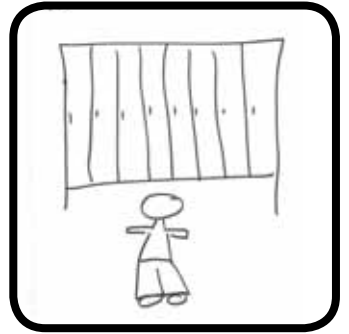
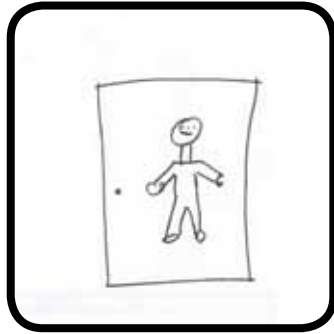
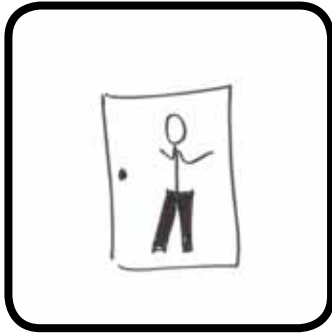

CONCLUSIONES:

CENTRO DE PROMOCIÓN DE AUTONOMÍA PERSONAL

LOCALIDAD: BERGONDO

GRUPO: USUARIOS

CENTRO DE PROMOCIÓN DE AUTONOMÍA PERSONAL - BERGONDO

REFERENTE: AULA DE FORMACIÓN

GRUPO: USUARIOS

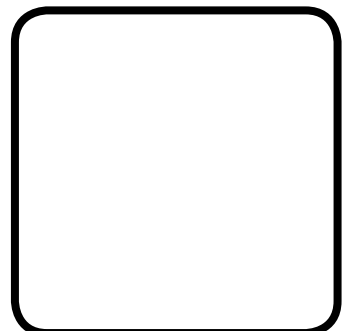
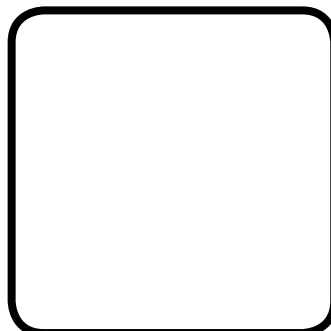
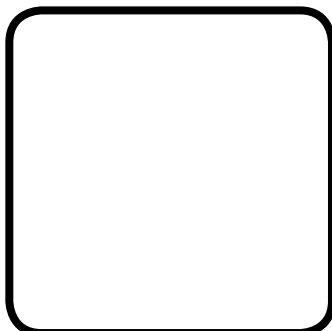
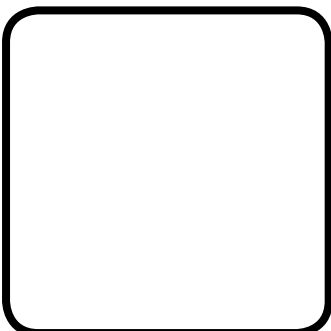
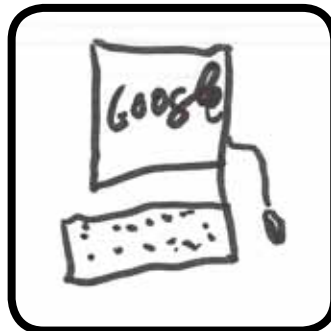
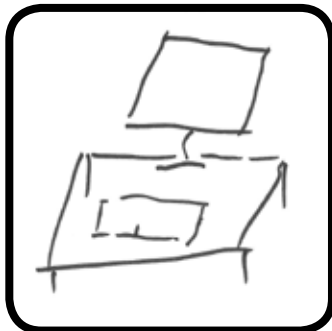
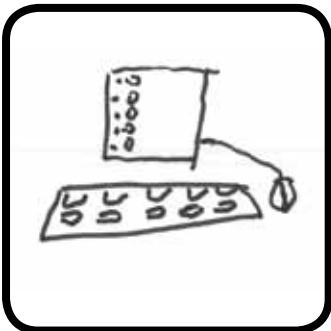
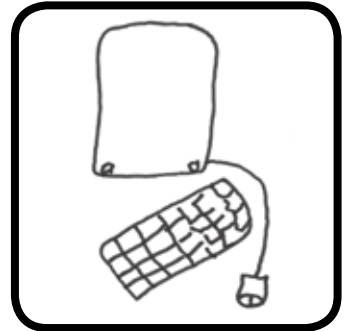
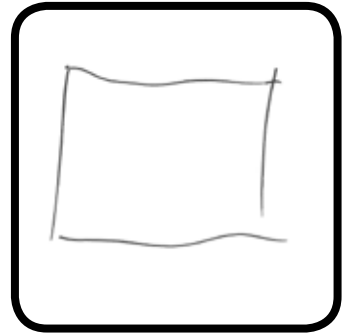
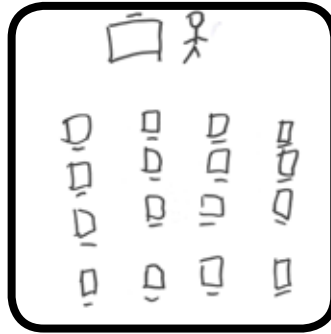
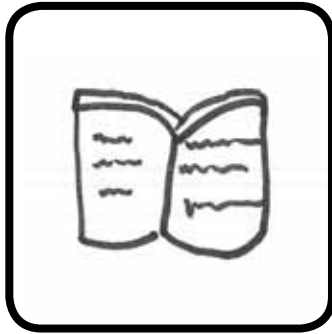
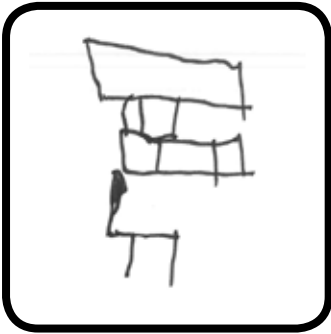

CONCLUSIONES:

CENTRO DE PROMOCIÓN DE AUTONOMÍA PERSONAL - BERGONDO

REFERENTE: **COMEDOR RESIDENTES**

GRUPO: **USUARIOS**

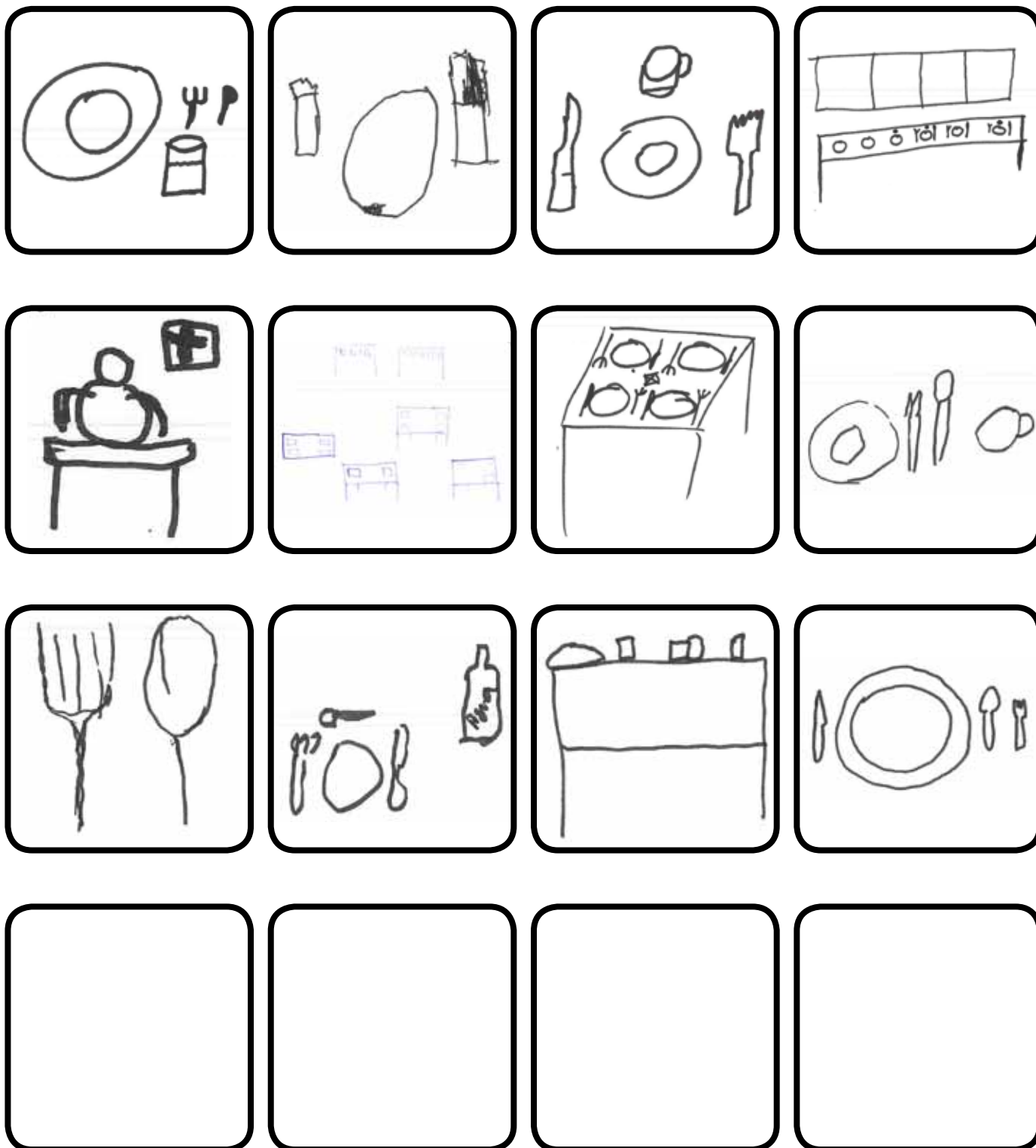

CONCLUSIONES:

CENTRO DE PROMOCIÓN DE AUTONOMÍA PERSONAL - BERGONDO

REFERENTE: CONSEJERÍA

GRUPO: USUARIOS

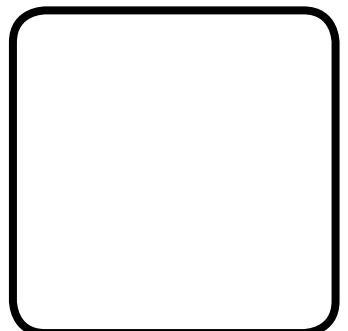
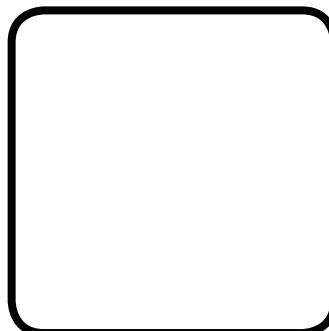
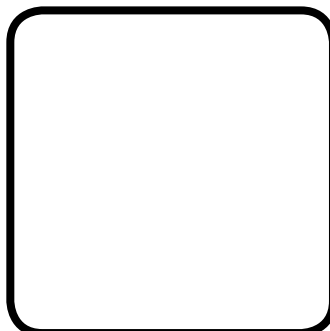
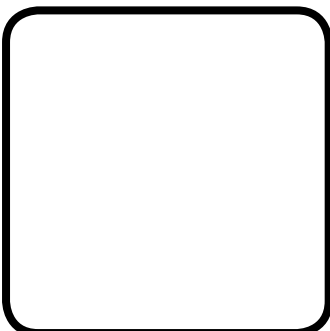
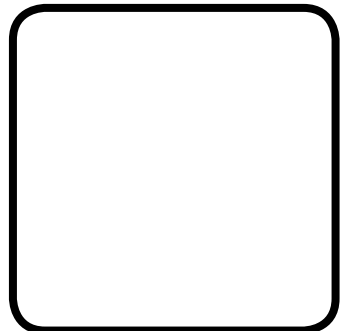
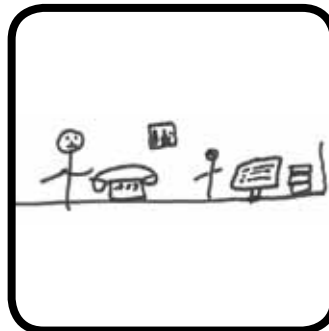
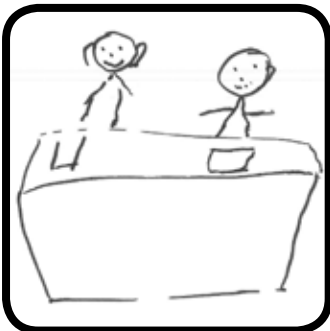
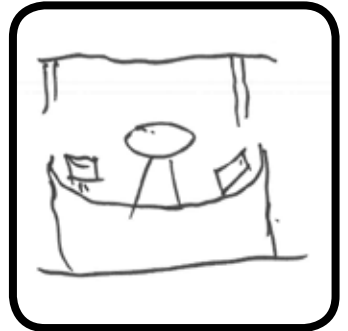
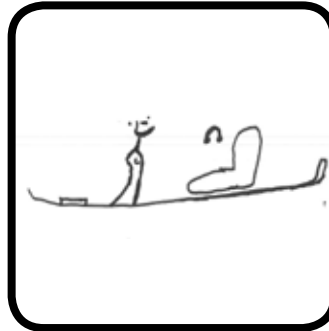
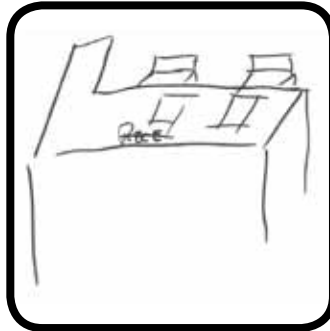
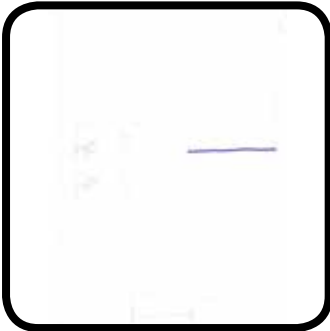
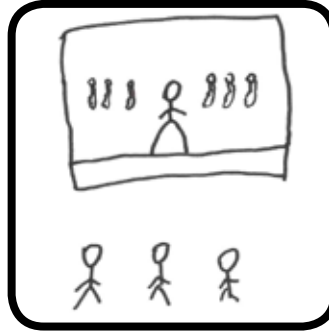
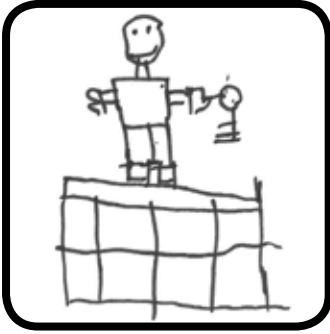

CONCLUSIONES:

CENTRO DE PROMOCIÓN DE AUTONOMÍA PERSONAL - BERGONDO

REFERENTE: DESPACHO JEFE ESTUDIOS

GRUPO: USUARIOS

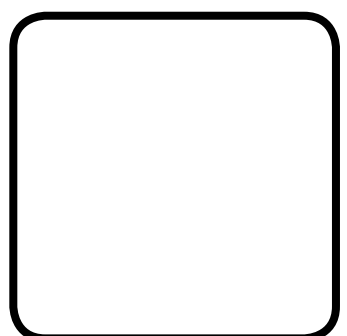
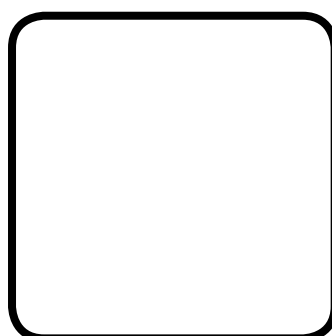
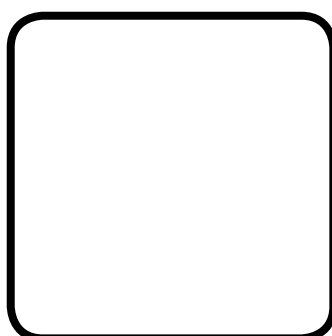
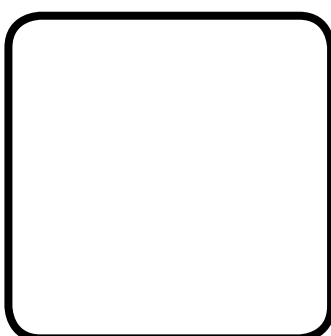
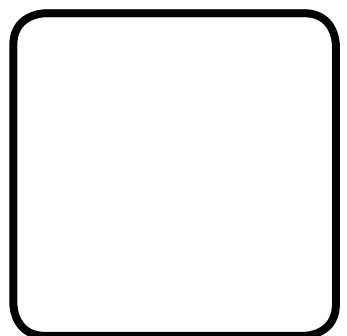
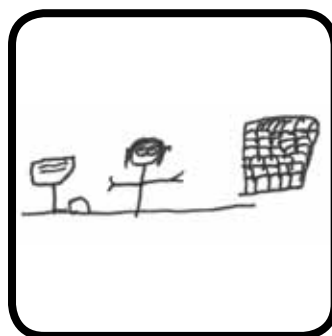
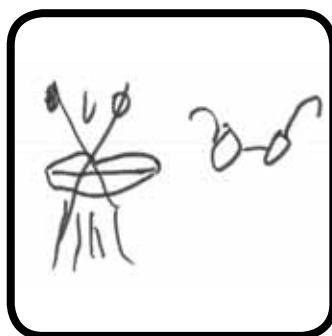
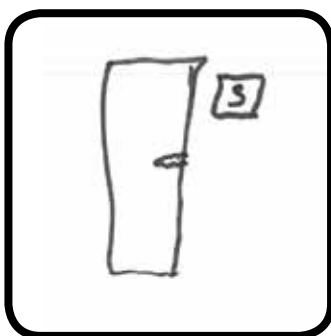
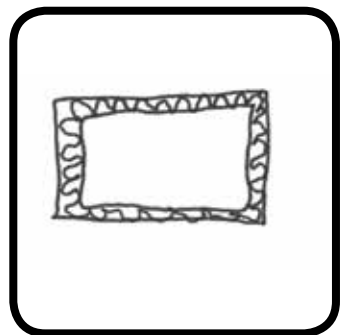
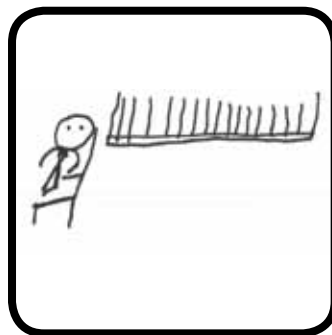
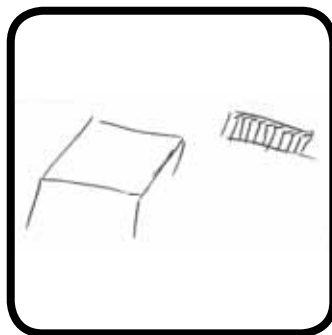
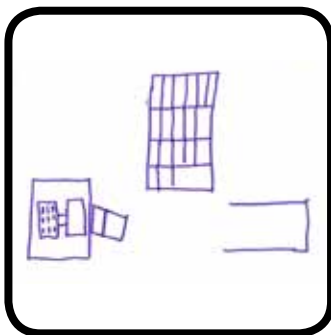
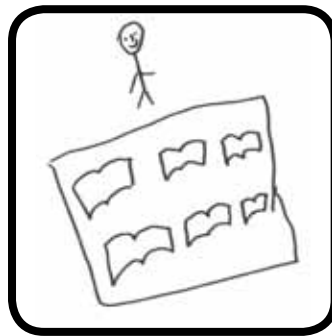
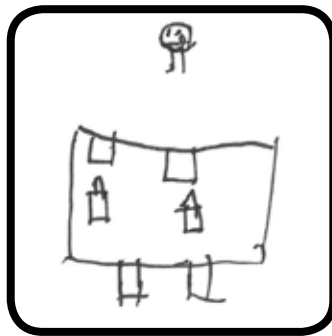
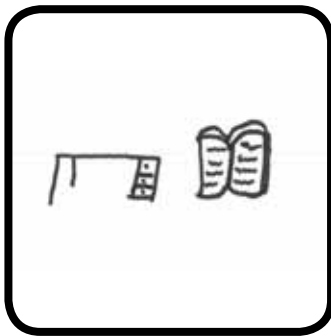

CONCLUSIONES:

CENTRO DE PROMOCIÓN DE AUTONOMÍA PERSONAL - BERGONDO

REFERENTE: **DESPACHO LOGOPEDA**

GRUPO: **USUARIOS**

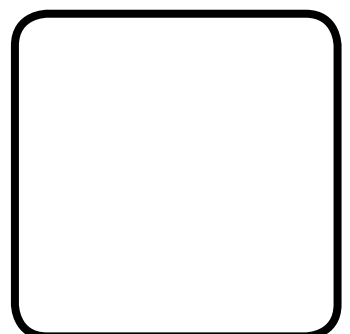
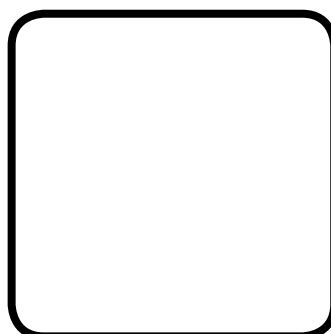
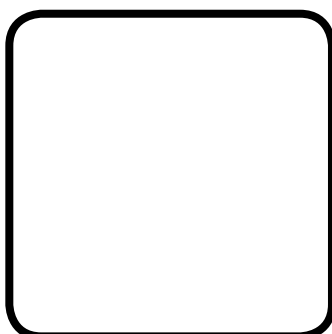
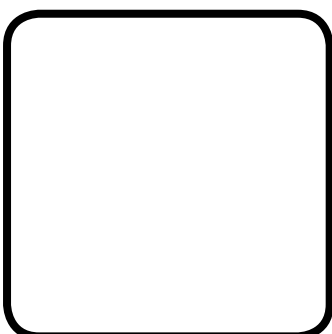
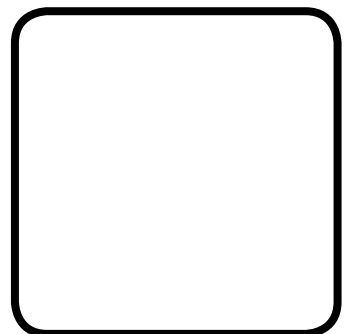
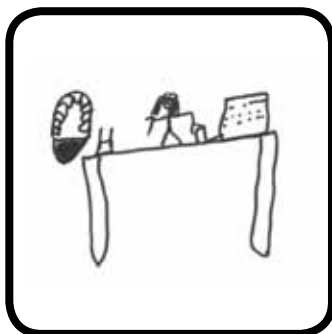
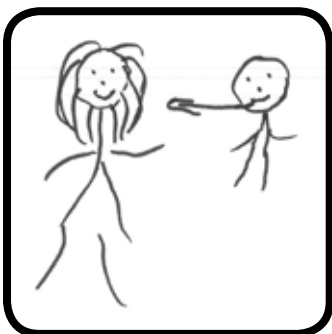
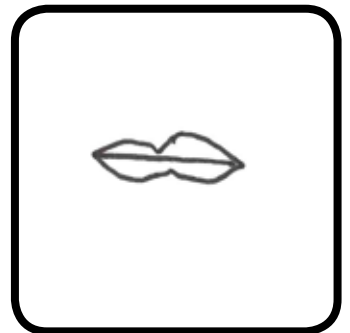
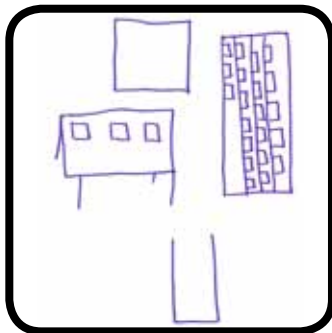
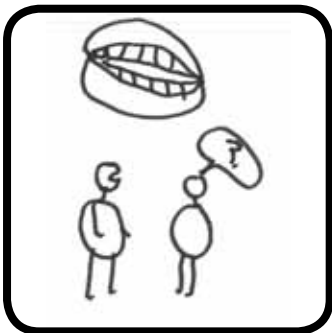
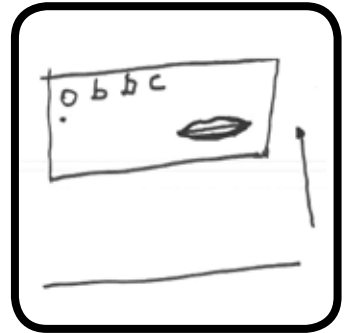
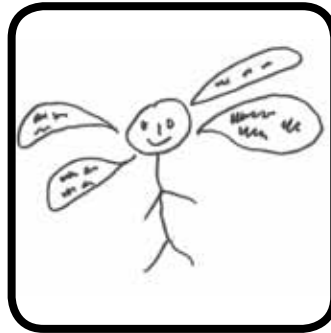
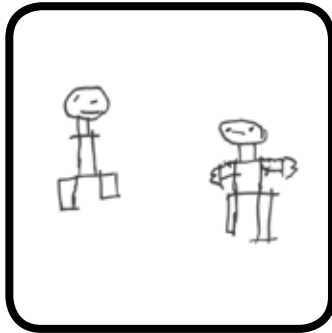
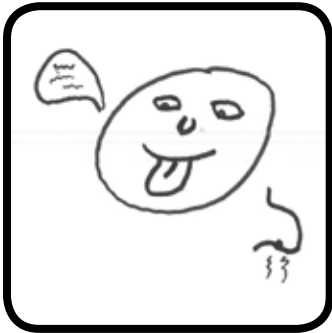

CONCLUSIONES:

CENTRO DE PROMOCIÓN DE AUTONOMÍA PERSONAL - BERGONDO

REFERENTE: **DESPACHO PSICÓLOGO**

GRUPO: **USUARIOS**

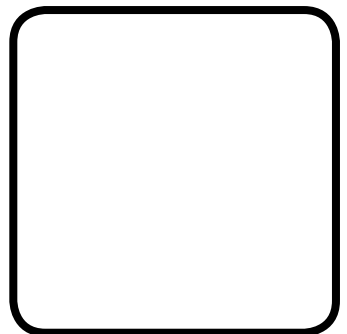
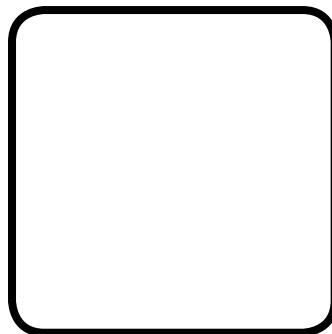
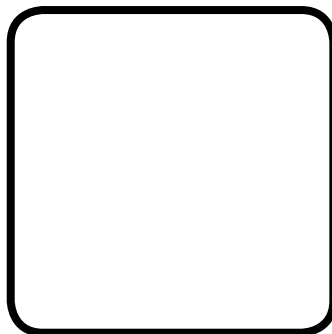
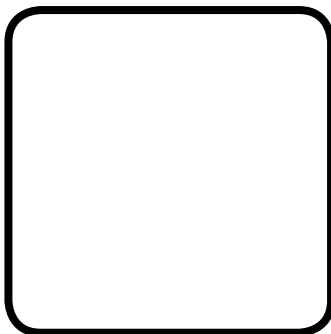
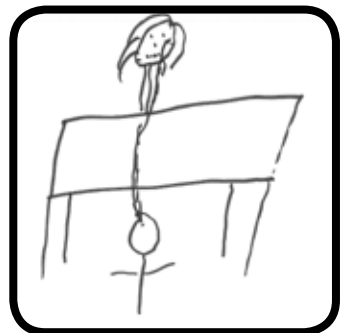
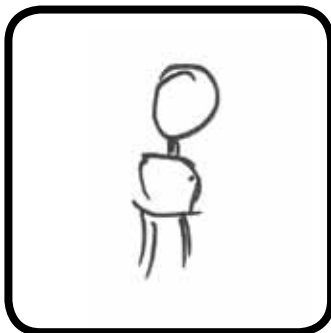
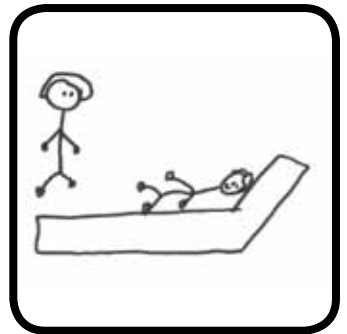
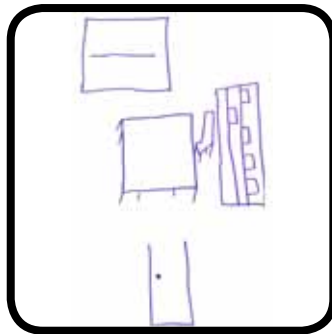
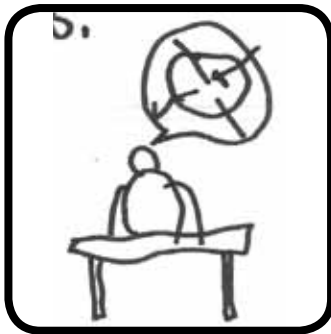
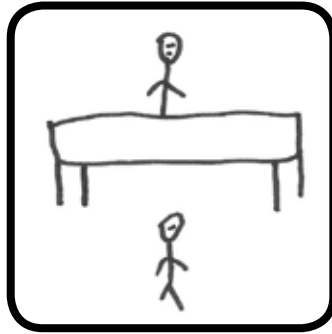
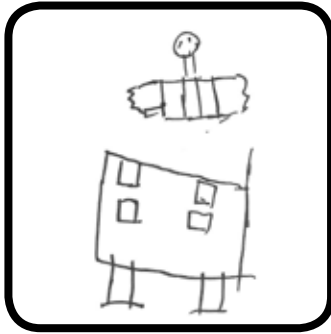

CONCLUSIONES:

CENTRO DE PROMOCIÓN DE AUTONOMÍA PERSONAL - BERGONDO

REFERENTE: RESPONSABLE ÁREA ASISTENCIAL

GRUPO: USUARIOS

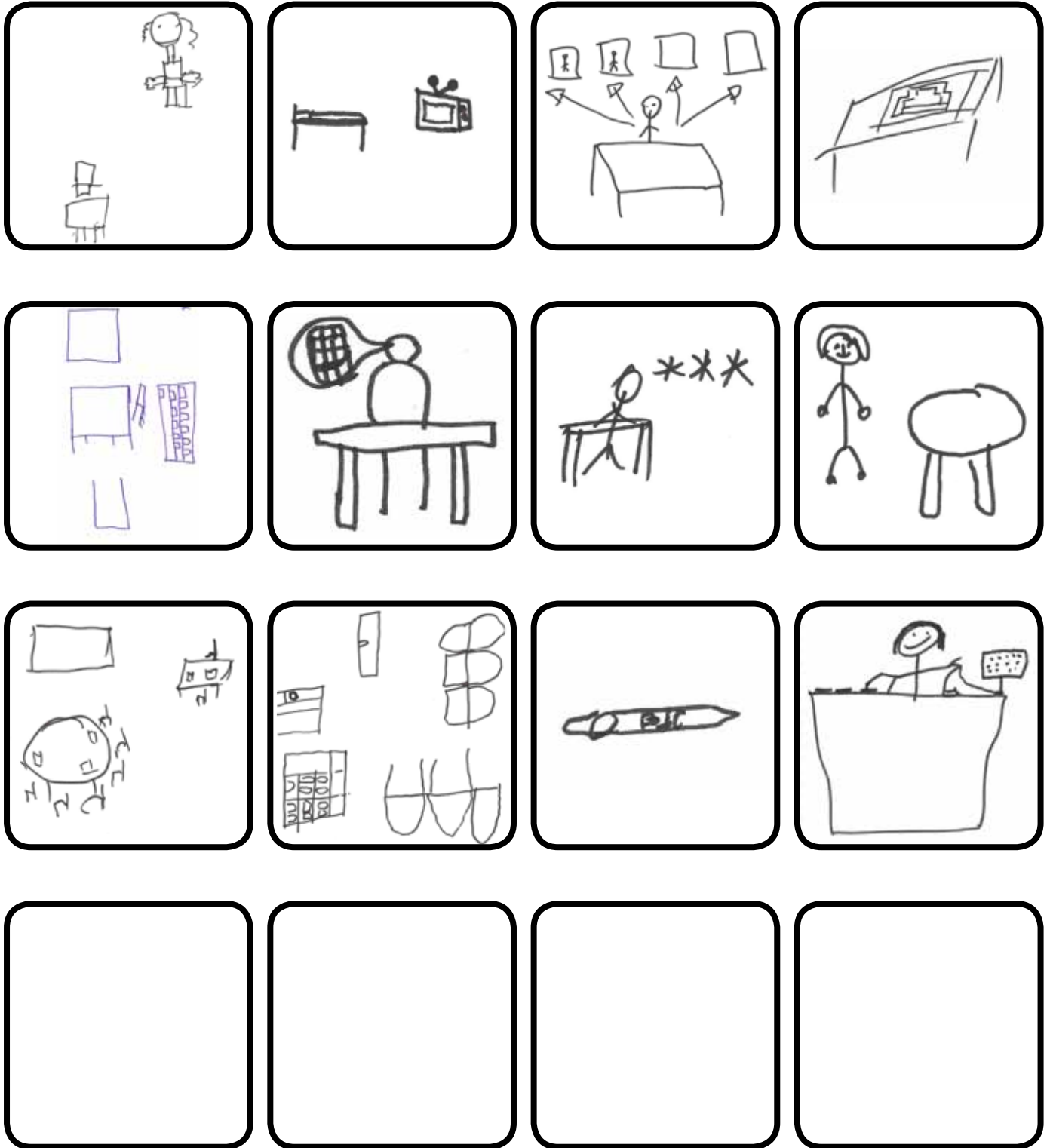

CONCLUSIONES:

CENTRO DE PROMOCIÓN DE AUTONOMÍA PERSONAL - BERGONDO

REFERENTE: TÉCNICO ORIENTACIÓN PROFESIONAL

GRUPO: USUARIOS

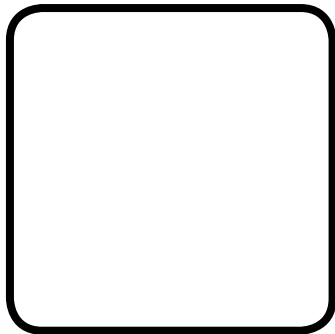
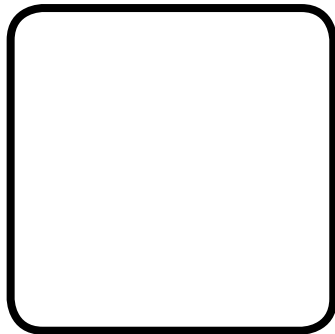
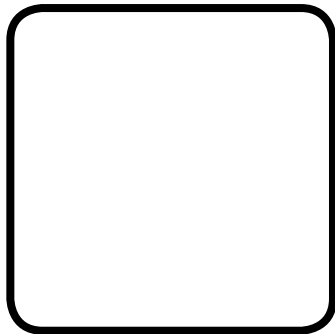
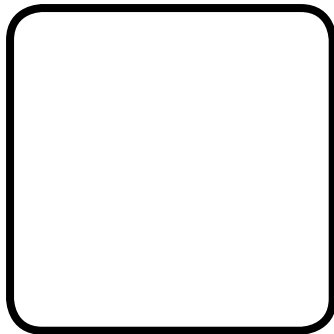
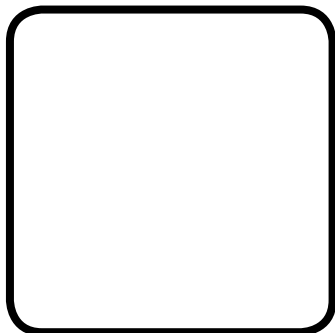
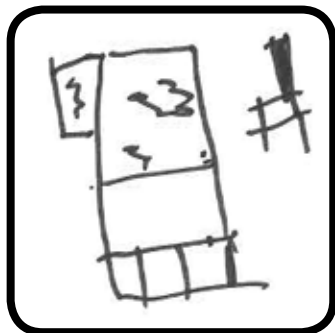
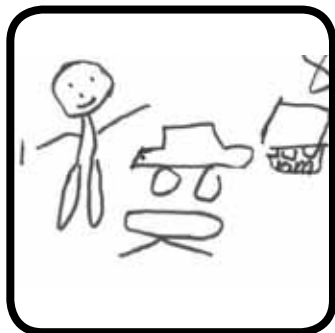
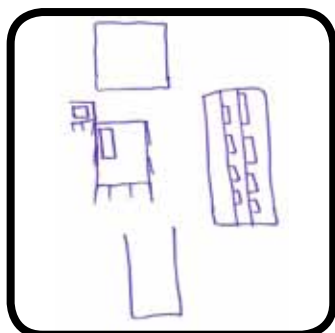
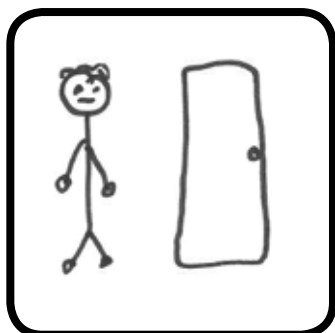
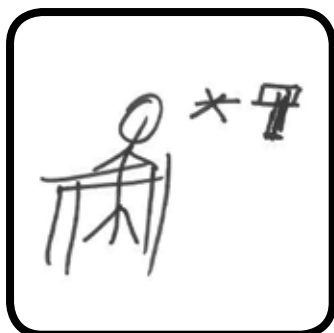
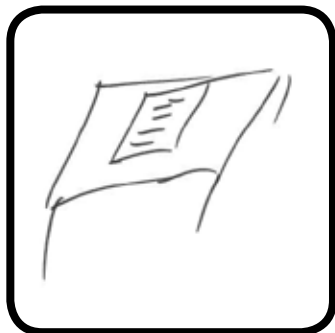
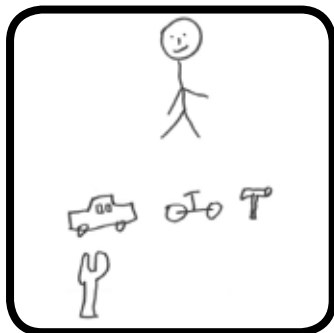

CONCLUSIONES:

CENTRO DE PROMOCIÓN DE AUTONOMÍA PERSONAL - BERGONDO

REFERENTE: TRABAJADOR SOCIAL

GRUPO: USUARIOS

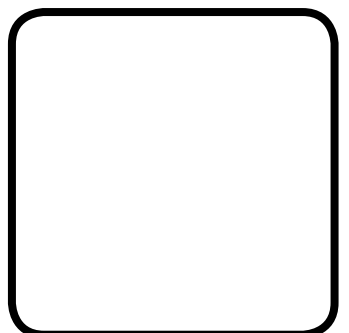
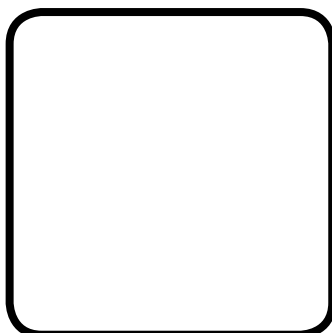
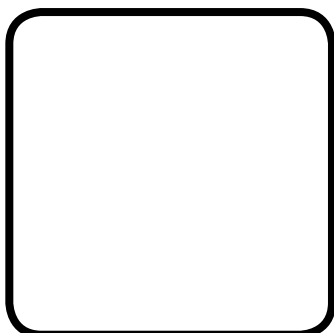
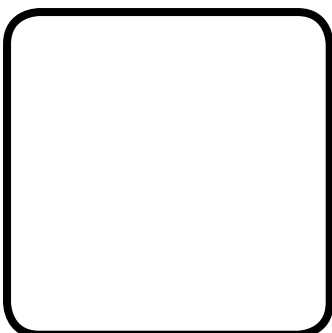
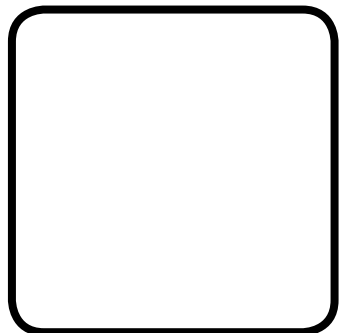
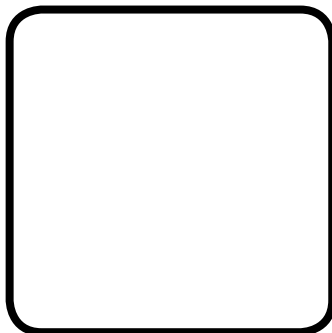
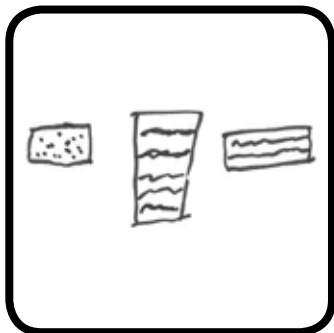
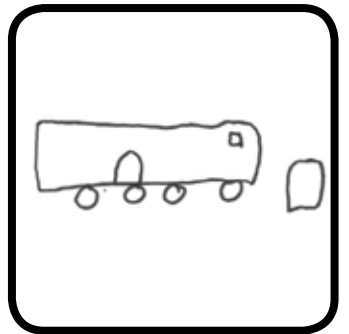
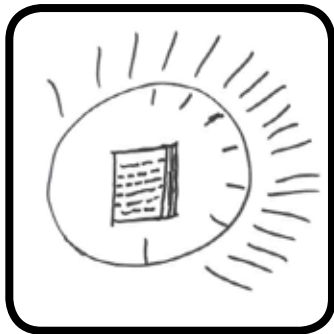
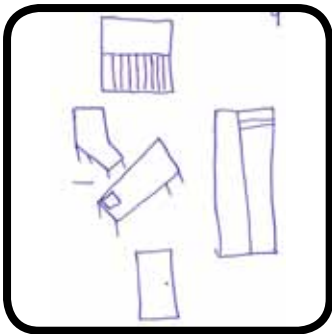
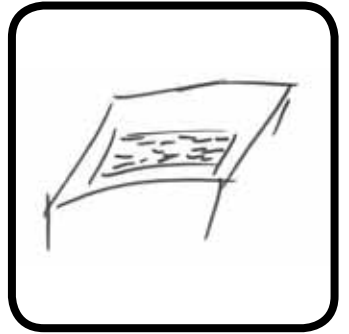
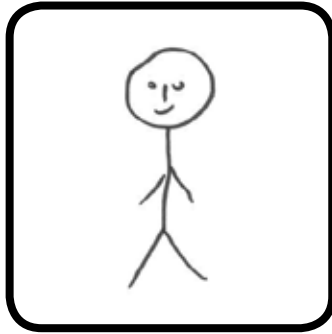
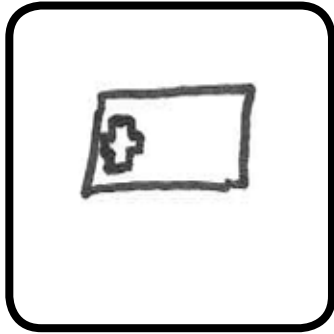
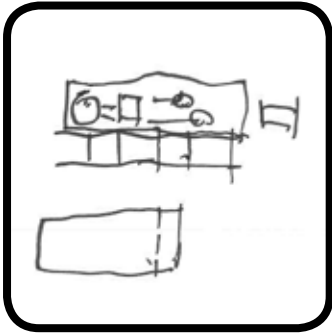

CONCLUSIONES:

CENTRO DE PROMOCIÓN DE AUTONOMÍA PERSONAL - BERGONDO

REFERENTE: GIMNASIO

GRUPO: USUARIOS

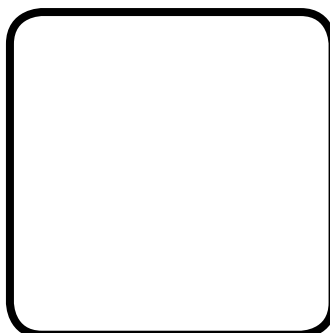
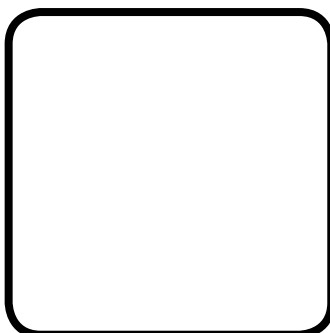
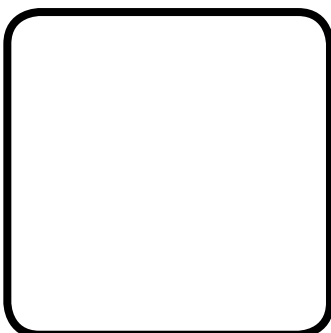
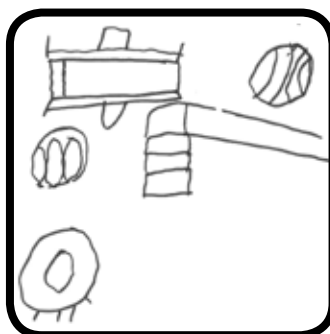
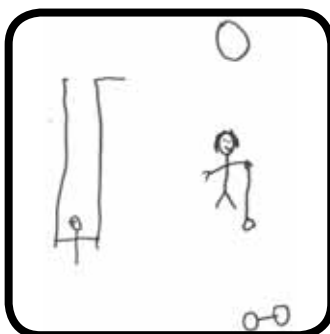
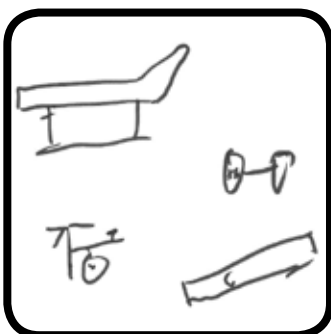
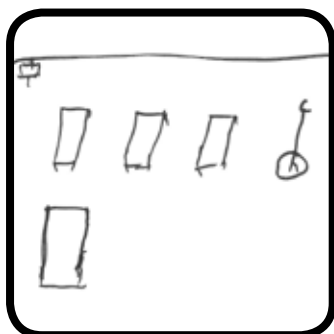
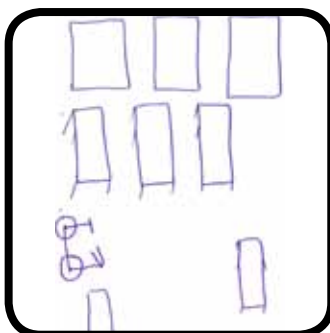
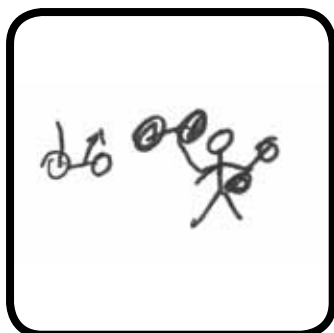
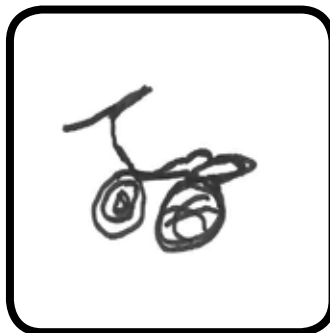
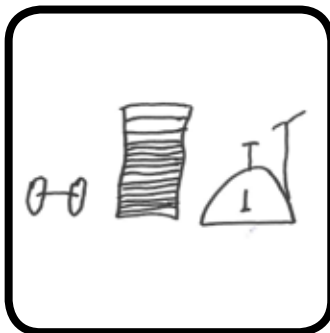
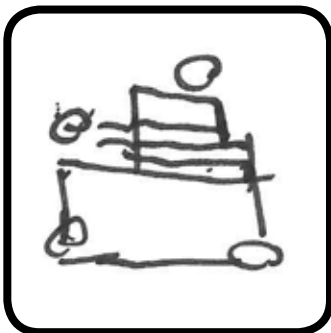
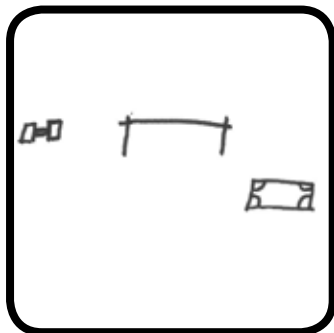

CONCLUSIONES:

CENTRO DE PROMOCIÓN DE AUTONOMÍA PERSONAL - BERGONDO

REFERENTE: SALA DE CUIDADORES

GRUPO: USUARIOS

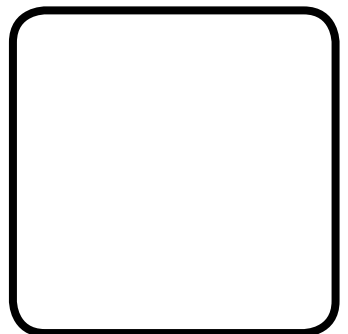
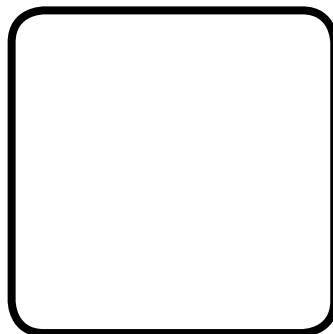
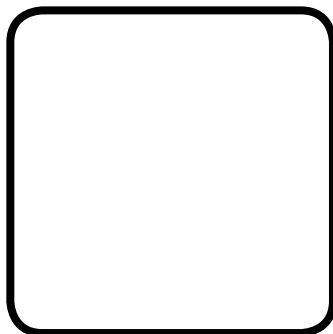
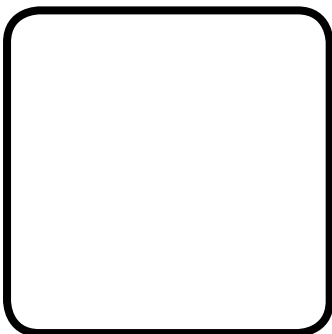
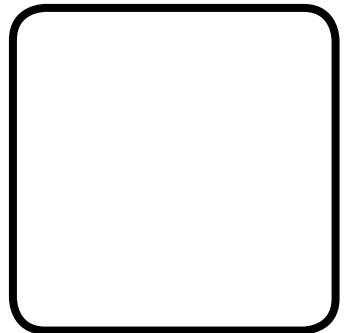
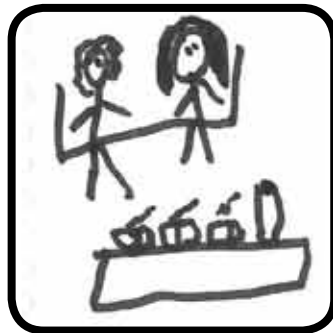
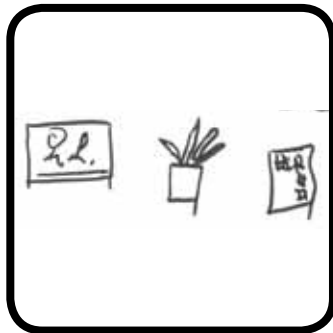
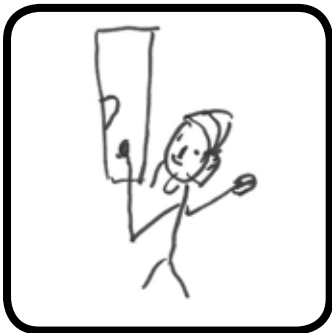
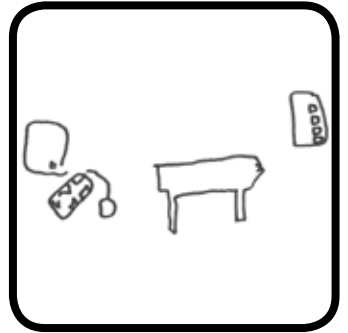
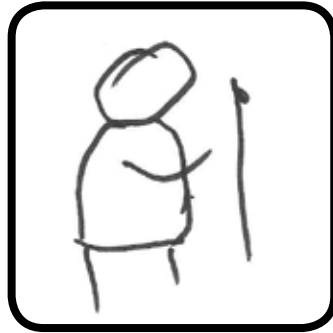
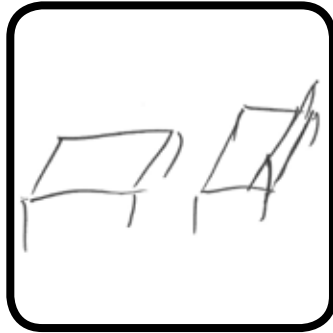
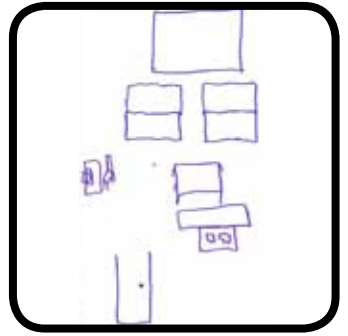
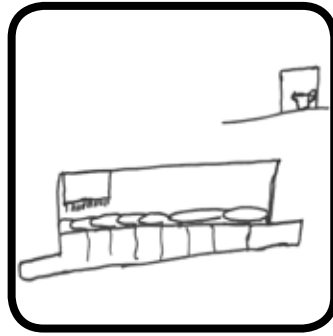
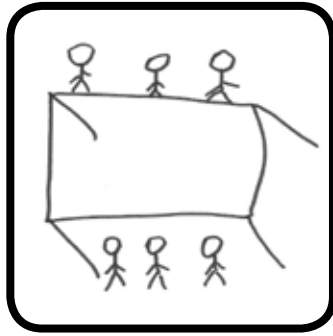
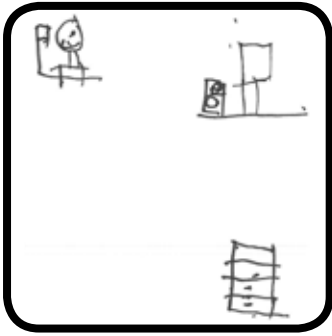

CONCLUSIONES:

CENTRO DE PROMOCIÓN DE AUTONOMÍA PERSONAL - BERGONDO

REFERENTE: SALA DE ATENCIÓN GRUPAL

GRUPO: USUARIOS

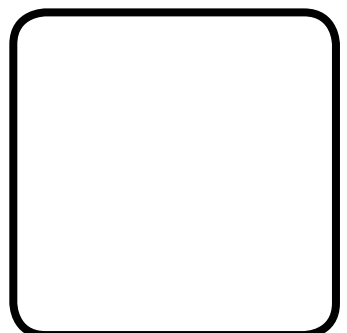
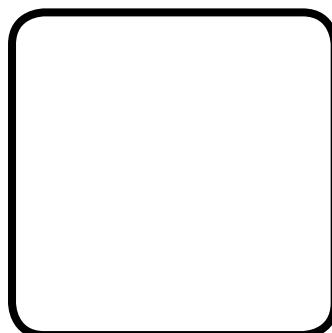
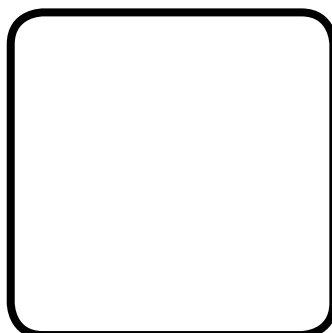
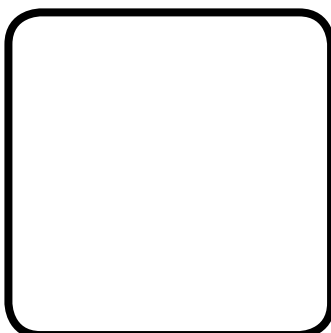
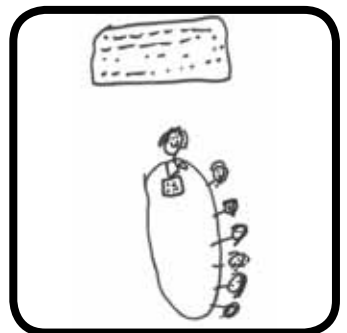
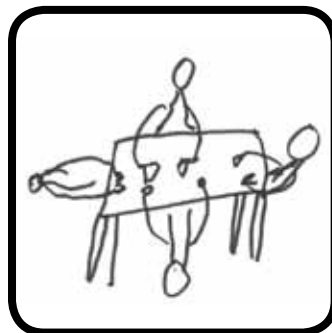
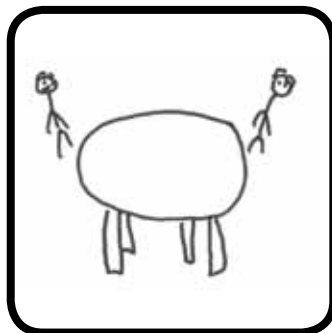
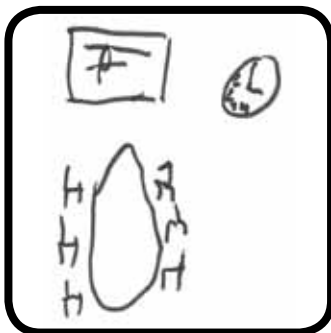
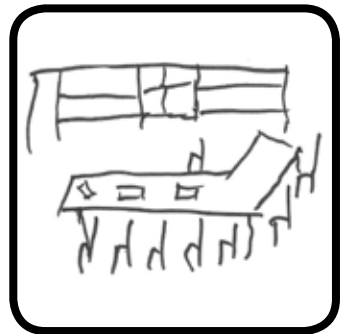
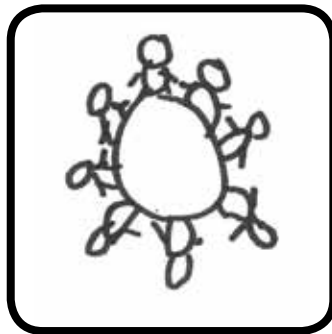
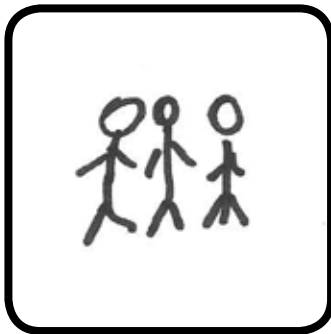
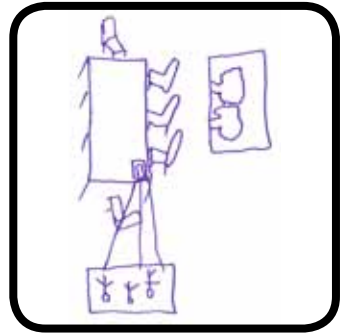
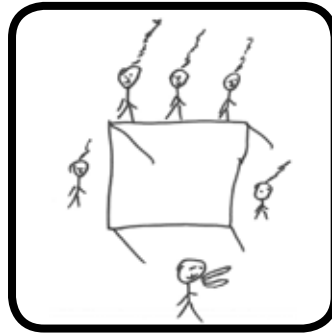
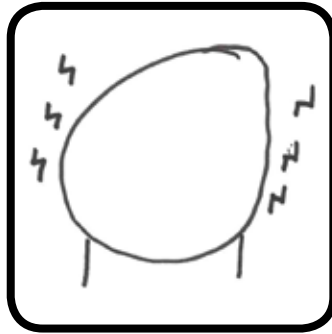
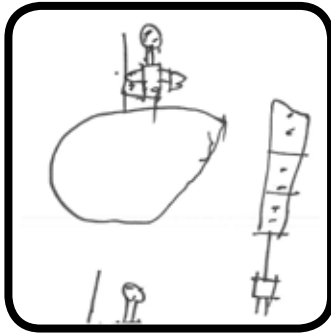

CONCLUSIONES:

CENTRO DE PROMOCIÓN DE AUTONOMÍA PERSONAL - BERGONDO

REFERENTE: SALA DE ENFERMERÍA

GRUPO: USUARIOS

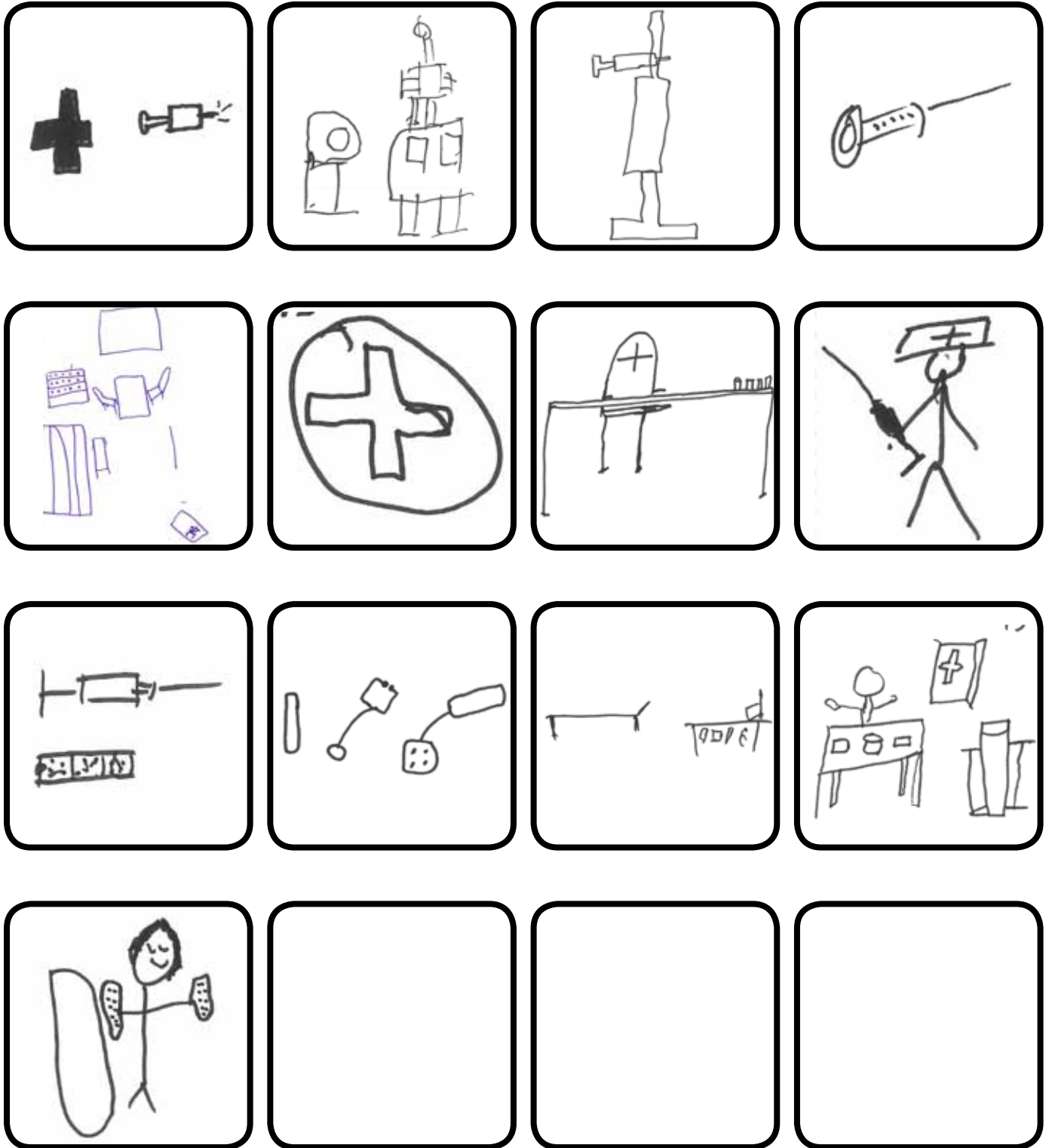

CONCLUSIONES:

CENTRO DE PROMOCIÓN DE AUTONOMÍA PERSONAL - BERGONDO

REFERENTE: SALA DE ESTAR

GRUPO: USUARIOS

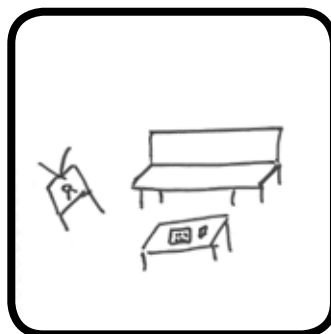
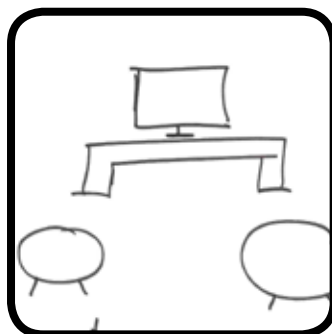
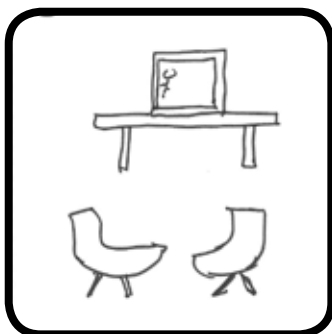
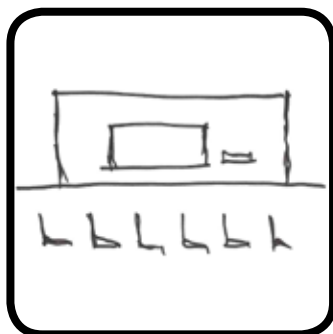
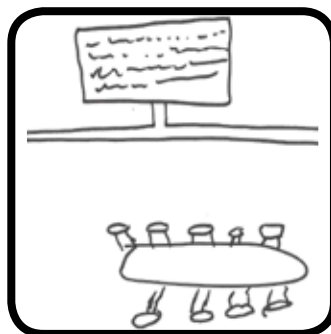
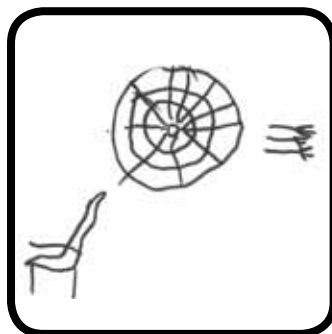
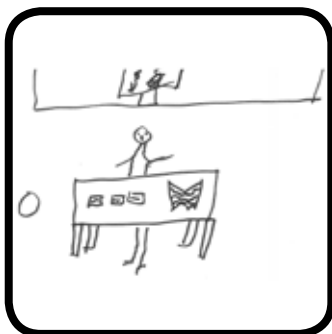
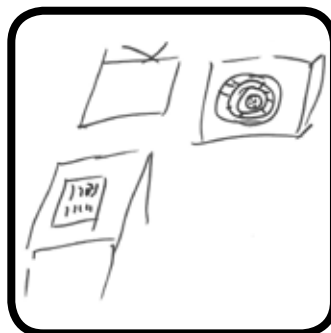
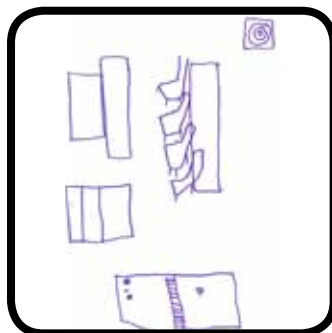
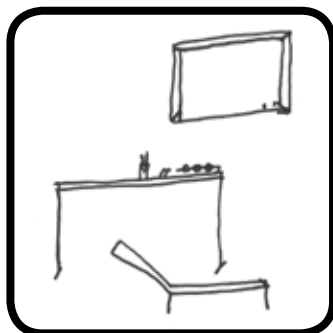
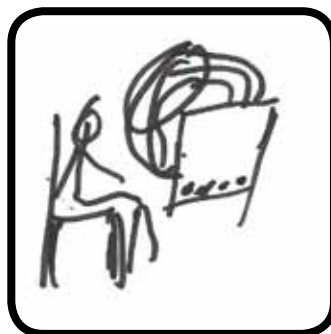
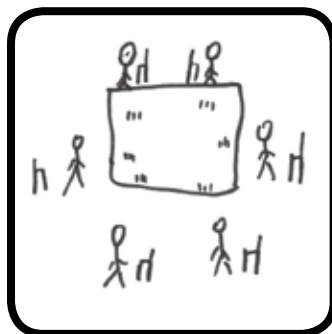
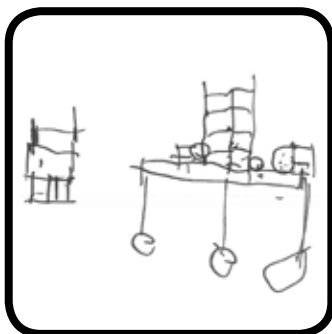

CONCLUSIONES:

CENTRO DE PROMOCIÓN DE AUTONOMÍA PERSONAL - BERGONDO

REFERENTE: SALA DE FISIOTERAPIA

GRUPO: USUARIOS

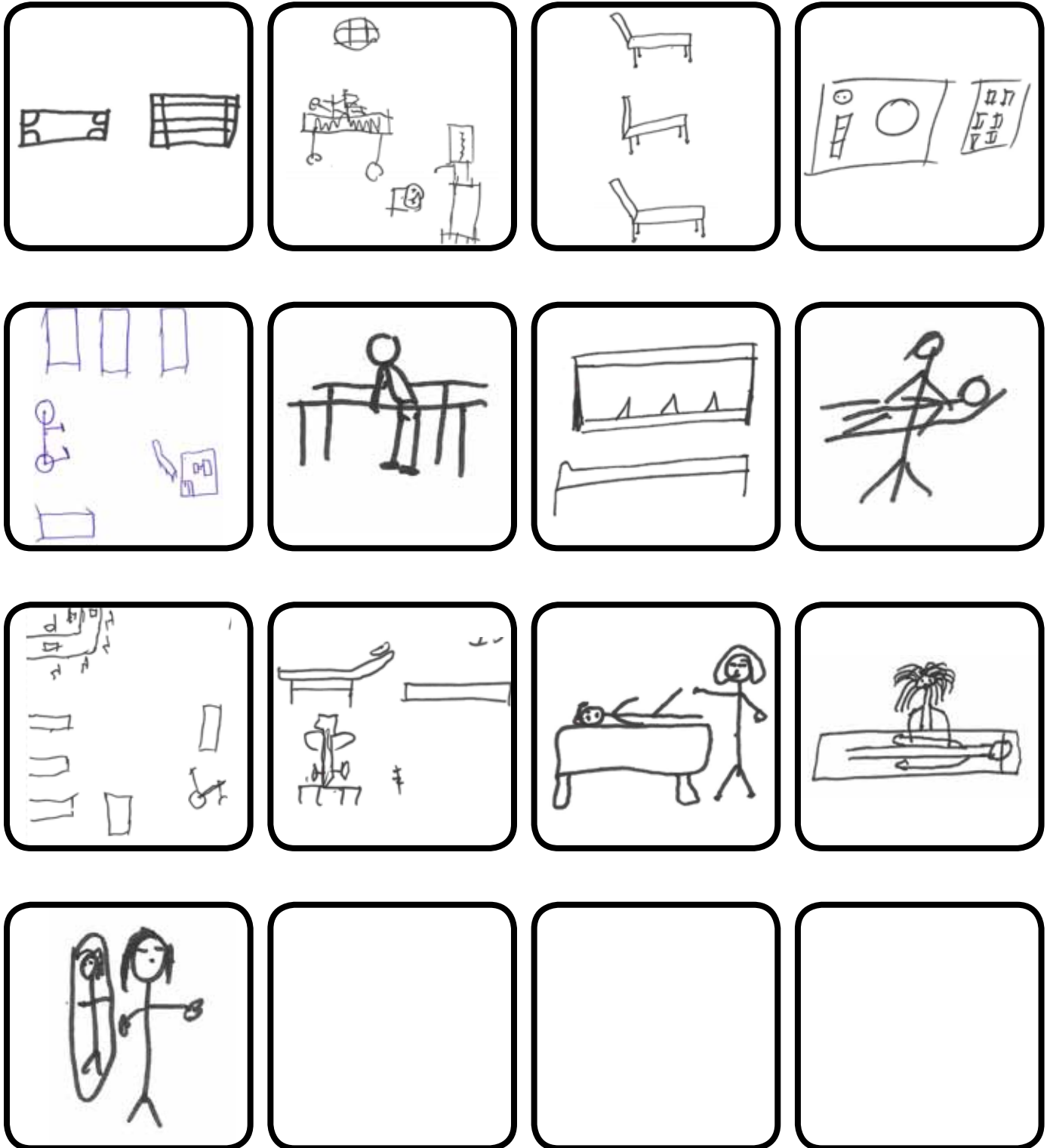

CONCLUSIONES:

CENTRO DE PROMOCIÓN DE AUTONOMÍA PERSONAL - BERGONDO

REFERENTE: **SALA DE JUNTAS**

GRUPO: **USUARIOS**

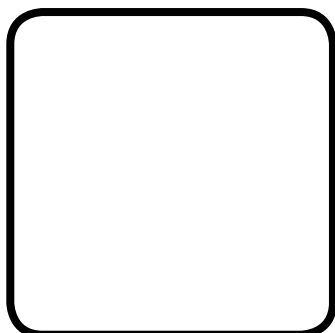
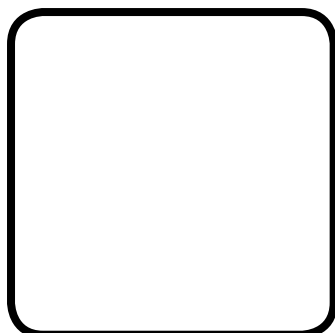
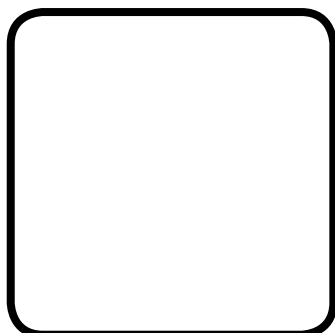
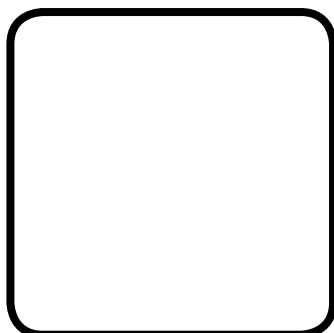
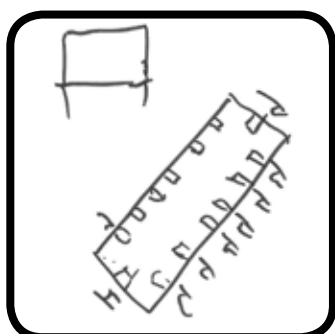
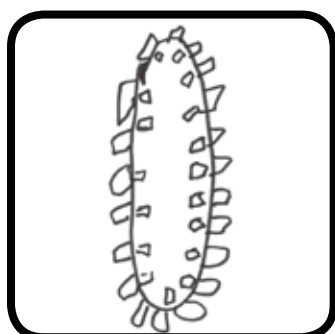
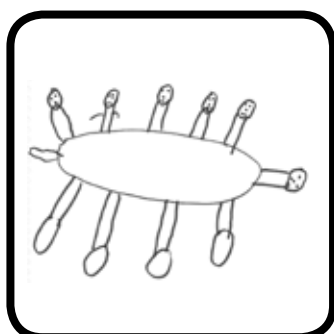
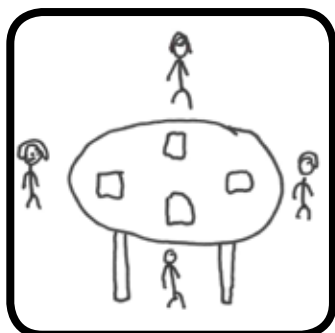
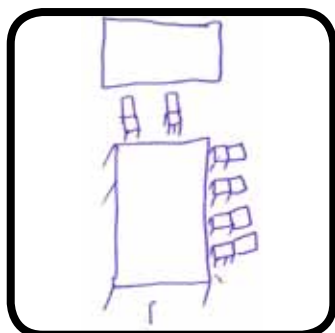
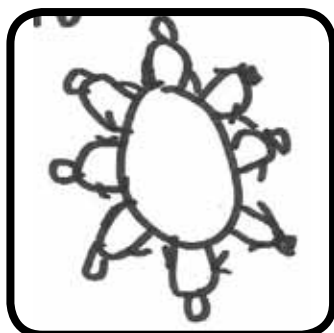
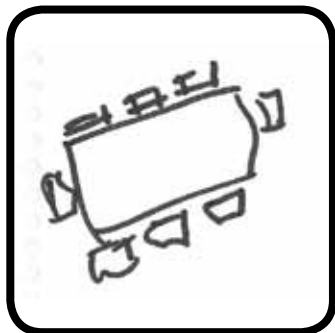
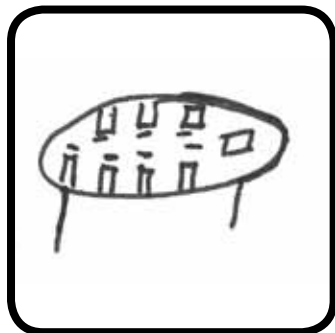
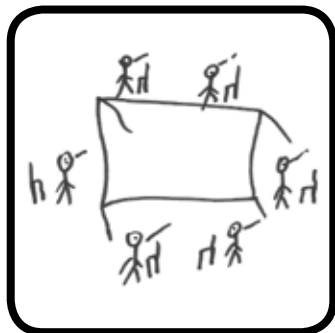
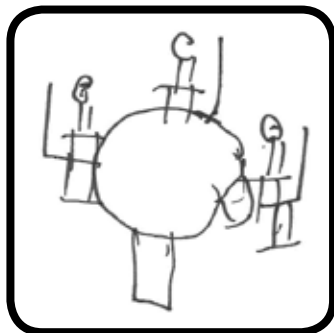

CONCLUSIONES:

CENTRO DE PROMOCIÓN DE AUTONOMÍA PERSONAL - BERGONDO

REFERENTE: **SALA POLIVALENTE**

GRUPO: USUARIOS

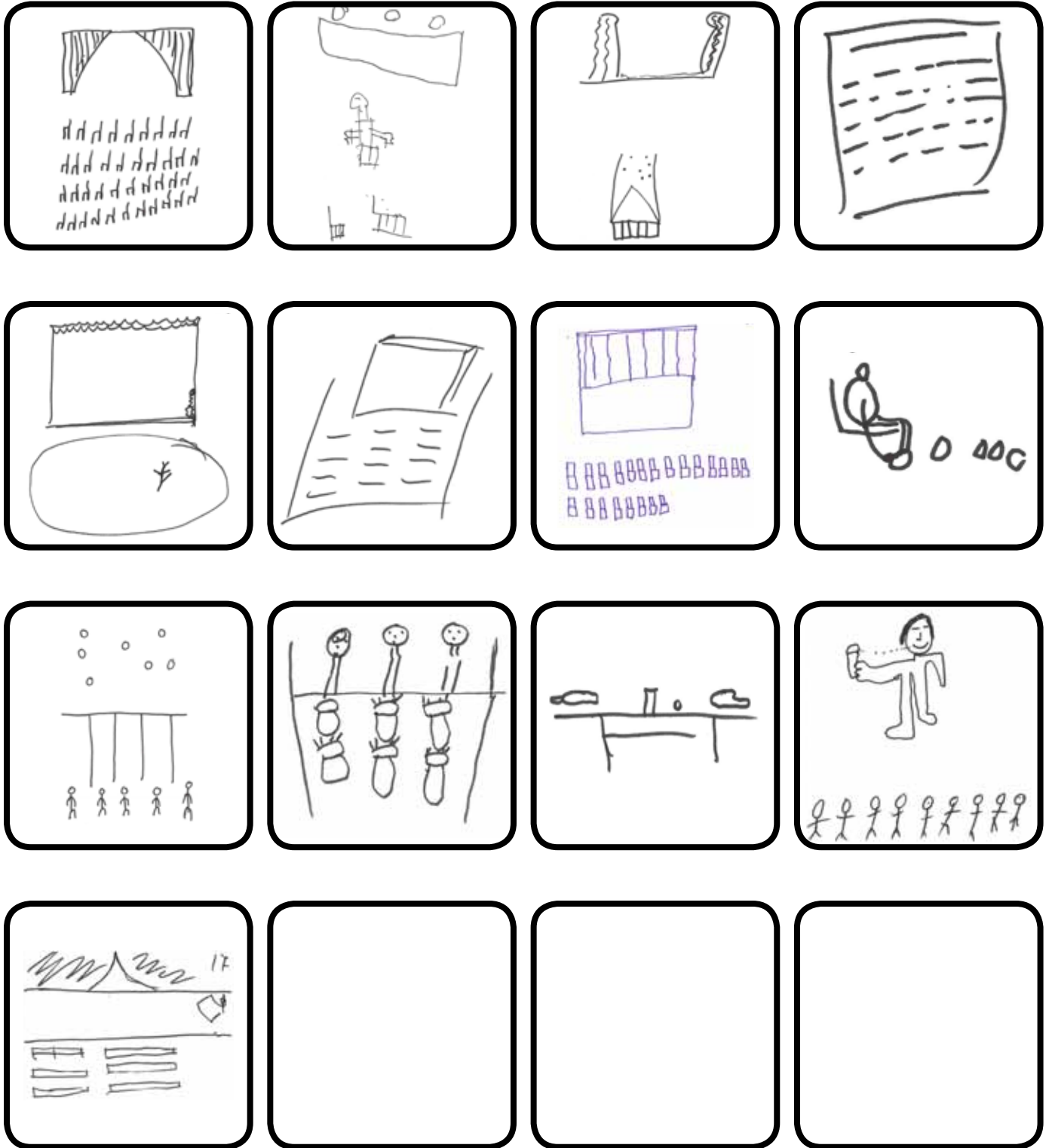

CONCLUSIONES:

CENTRO DE PROMOCIÓN DE AUTONOMÍA PERSONAL - BERGONDO

REFERENTE: SALA DE TERAPIA OCUPACIONAL

GRUPO: USUARIOS

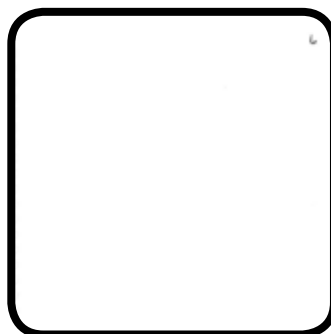
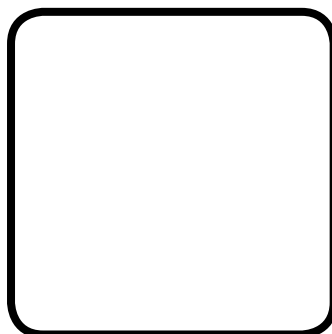
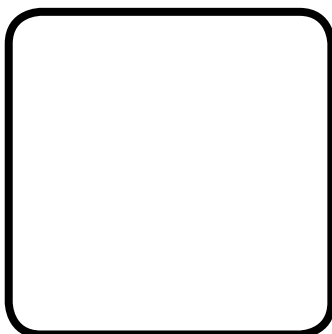
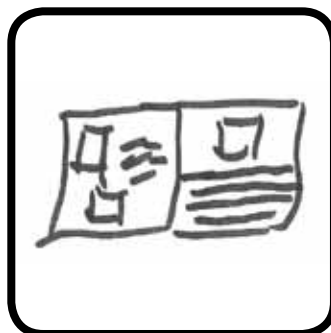
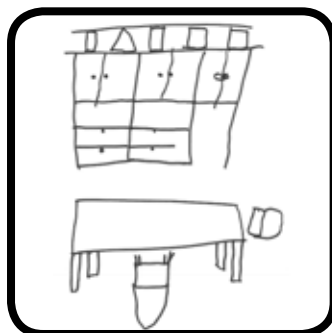
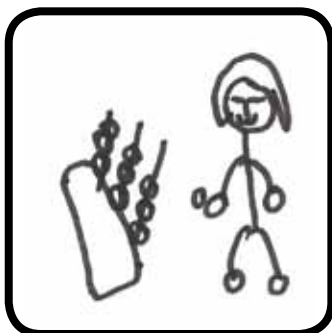
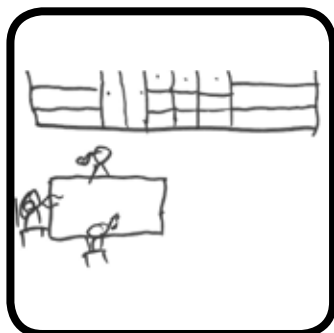
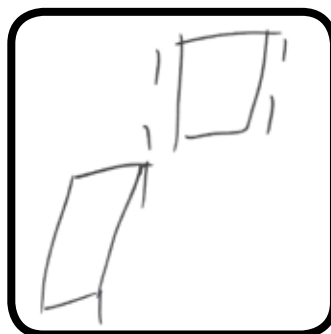
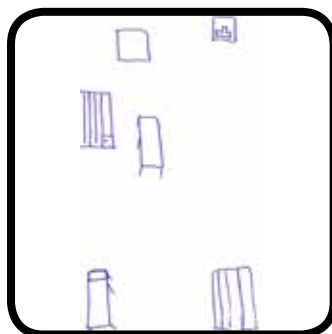
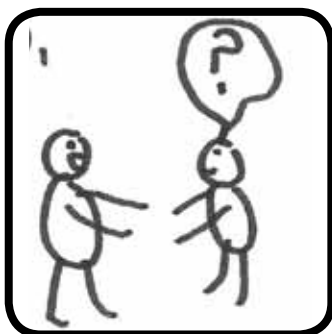
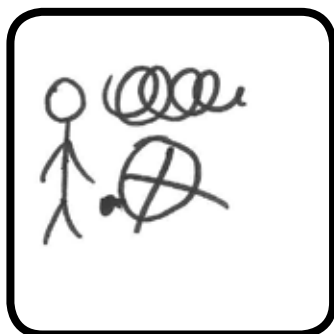
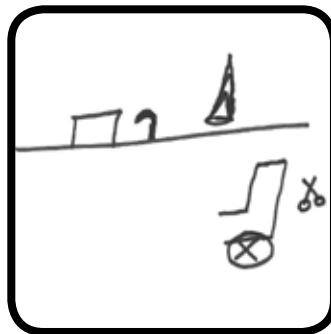
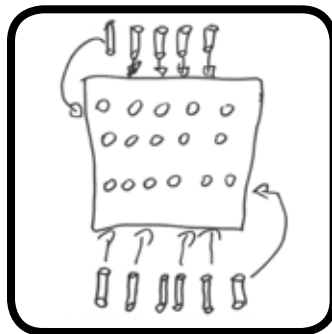
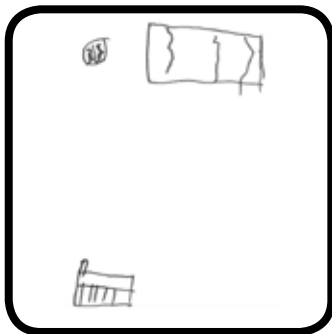
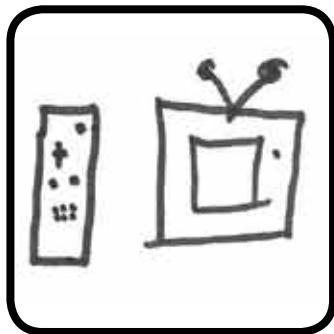

CONCLUSIONES:

CENTRO DE PROMOCIÓN DE AUTONOMÍA PERSONAL - BERGONDO

REFERENTE: TALLER CREATIVO

GRUPO: USUARIOS

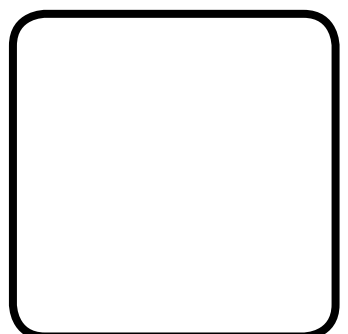
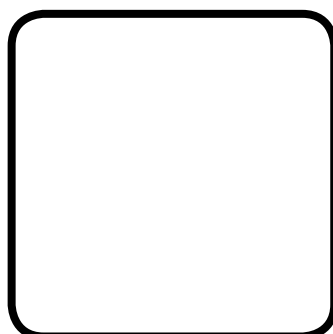
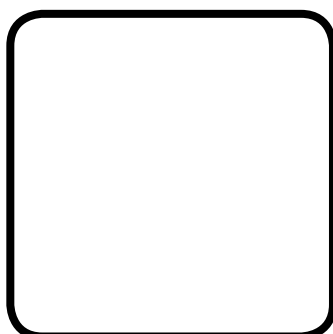
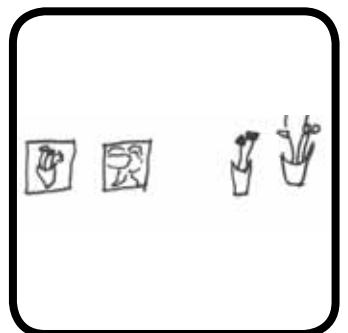
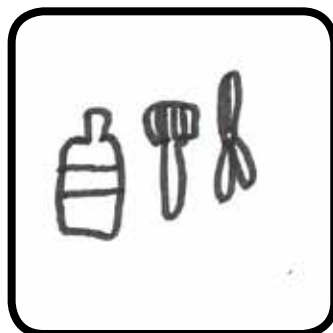
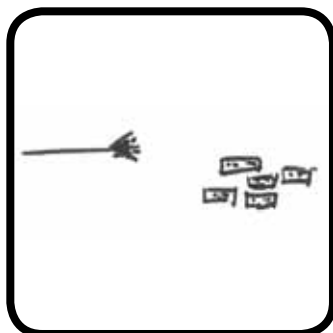
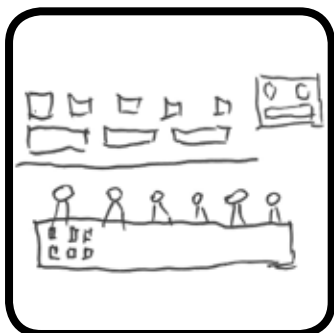
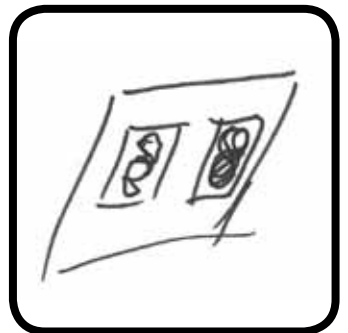
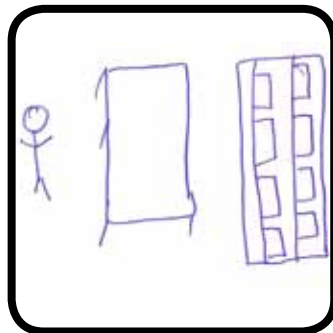
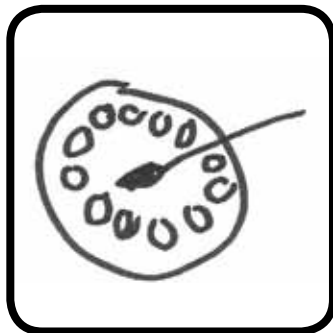
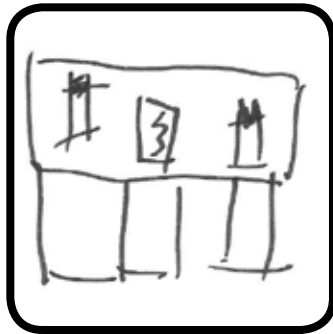
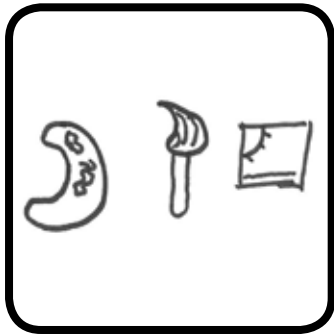

CONCLUSIONES:

CENTRO DE PROMOCIÓN DE AUTONOMÍA PERSONAL - BERGONDO

REFERENTE: BIBLIOTECA

GRUPO: USUARIOS

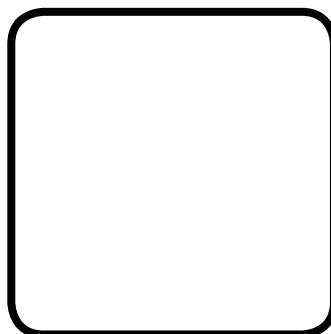
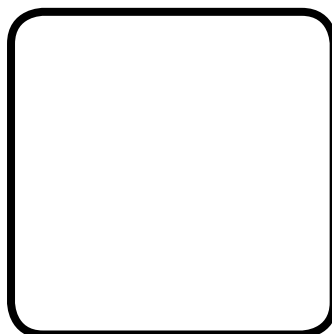
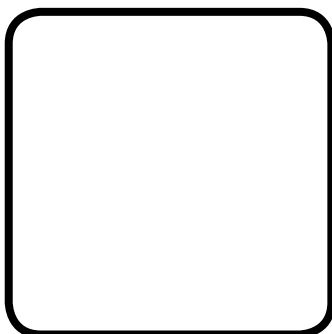
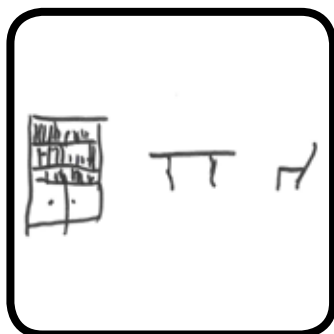
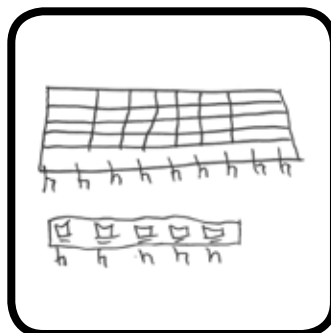
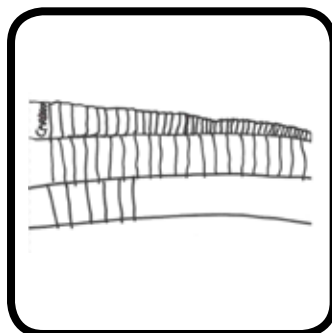
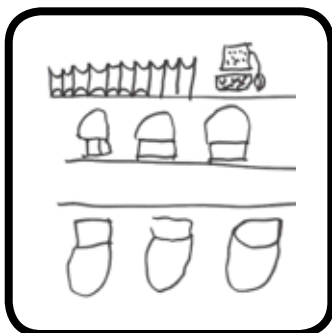
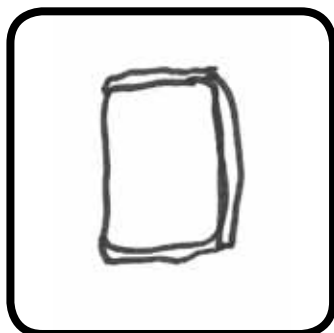
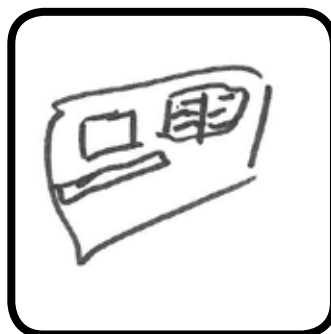
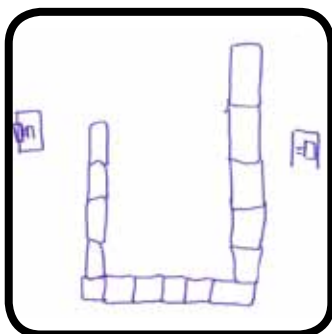
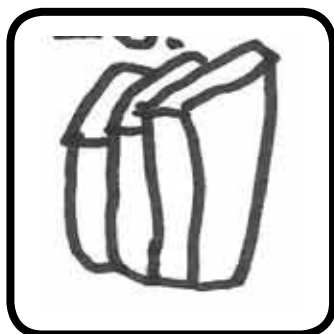
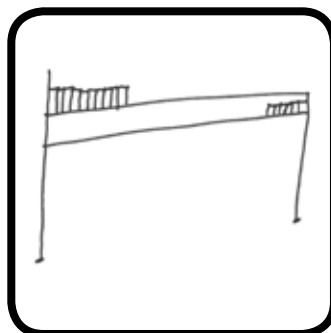
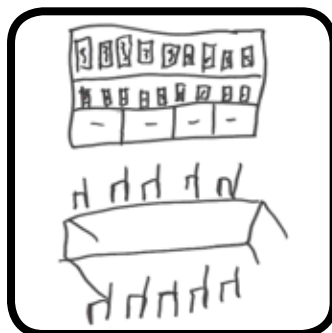
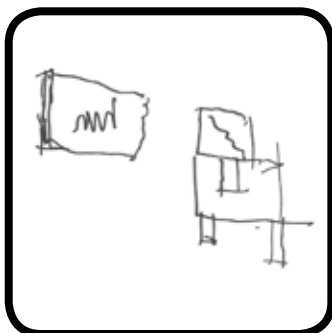
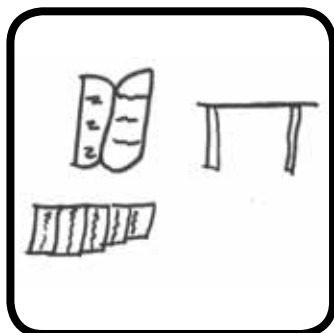

CONCLUSIONES:

CENTRO DE PROMOCIÓN DE AUTONOMÍA PERSONAL - BERGONDO

REFERENTE: CAFETERÍA

GRUPO: USUARIOS

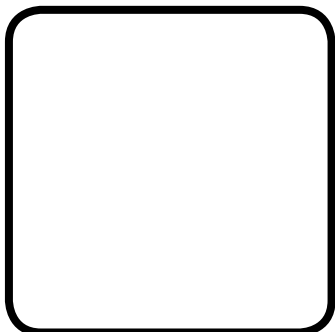
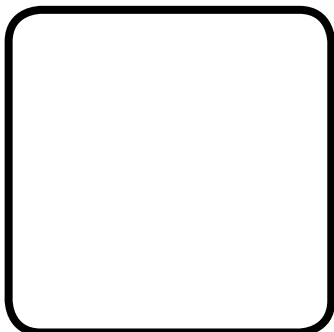
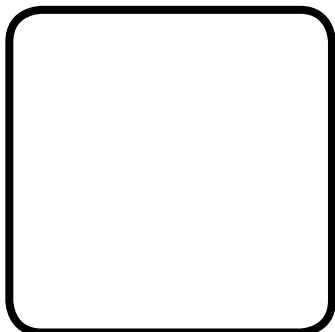
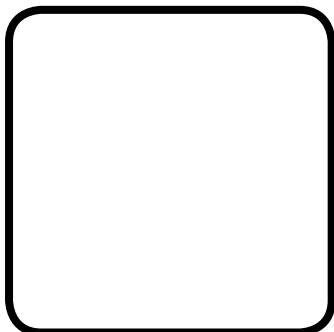
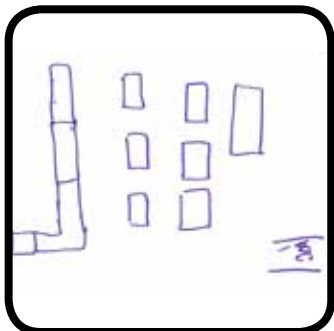
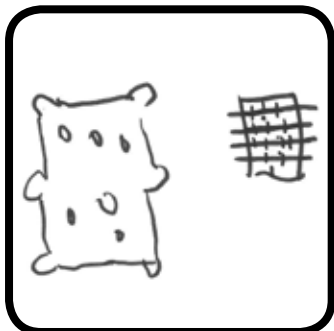
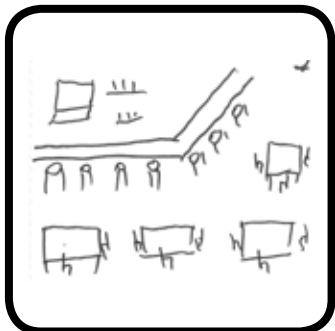
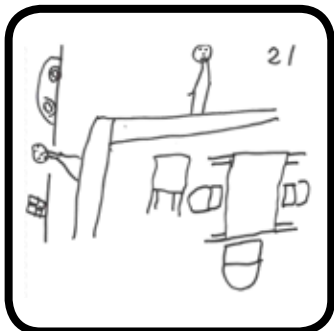
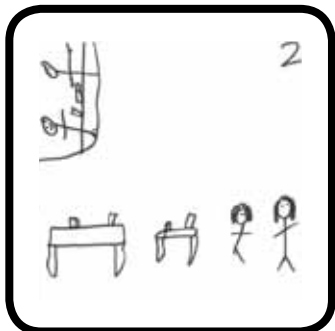
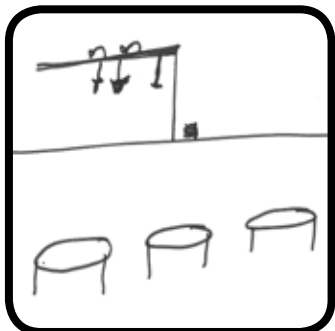
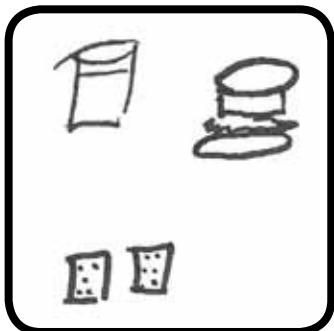
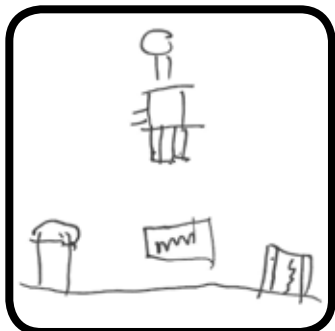
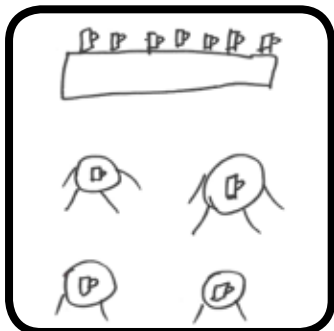

CONCLUSIONES:

CENTRO DE PROMOCIÓN DE AUTONOMÍA PERSONAL - BERGONDO

REFERENTE: **DIRECTOR**

GRUPO: **USUARIOS**

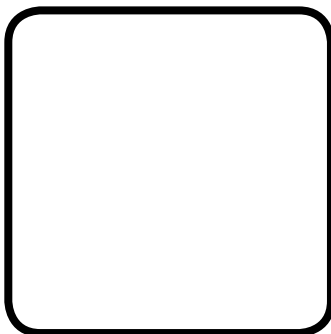
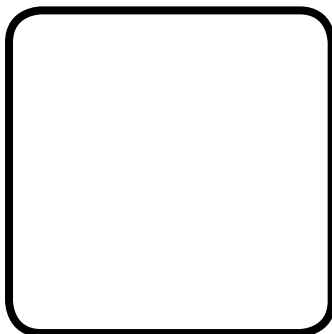
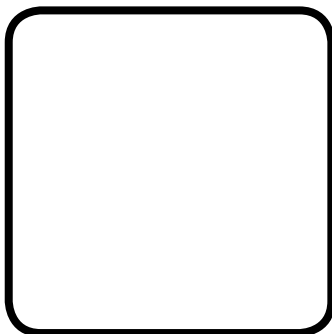
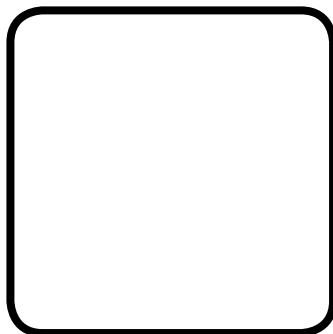
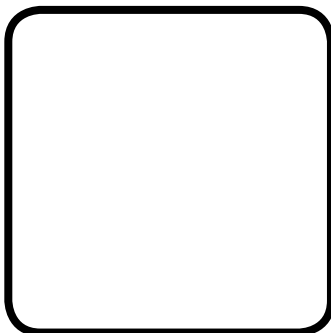
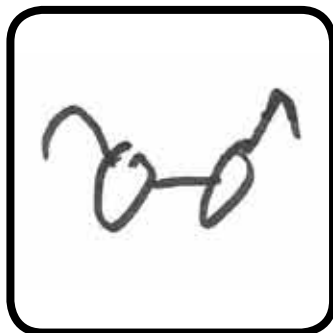
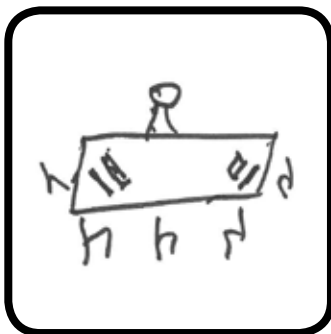
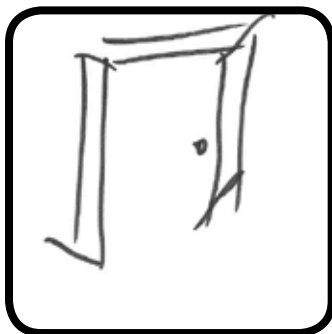
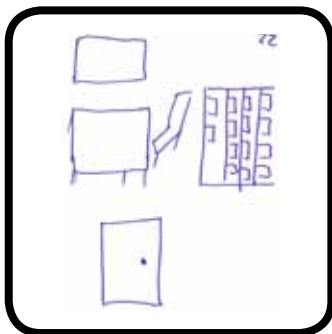
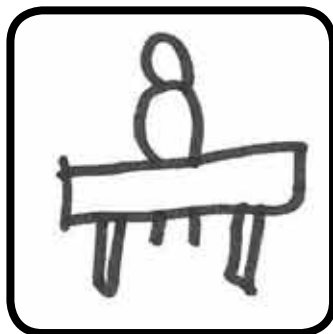
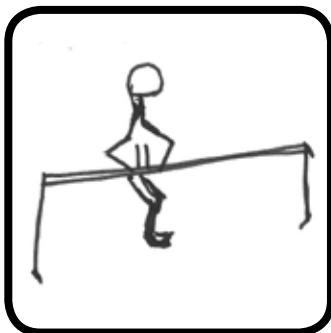
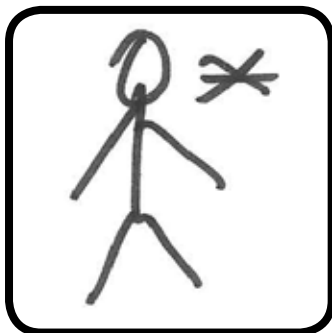
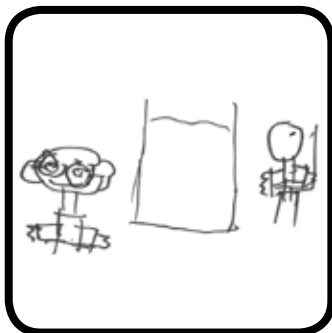
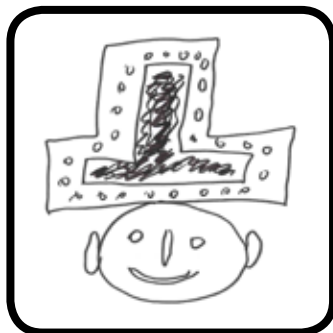

CONCLUSIONES:

CENTRO DE PROMOCIÓN DE AUTONOMÍA PERSONAL - BERGONDO

REFERENTE: DORMITORIO

GRUPO: USUARIOS

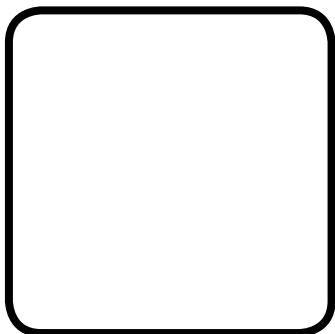
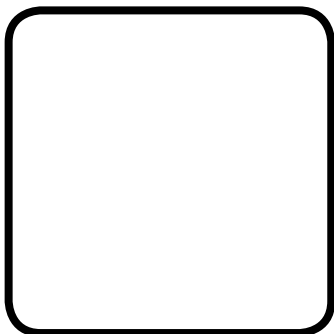
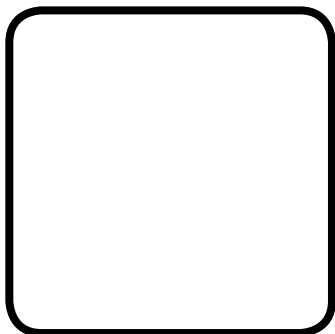
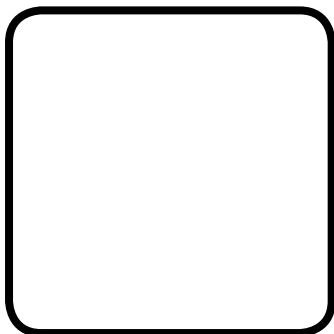
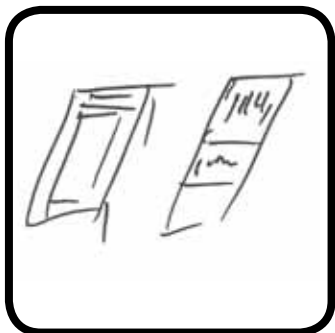
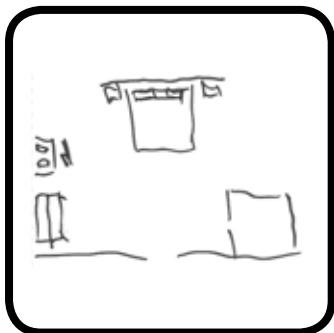
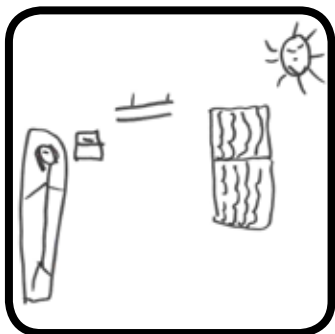
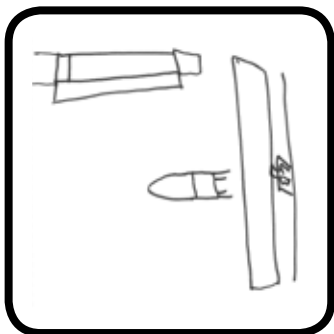
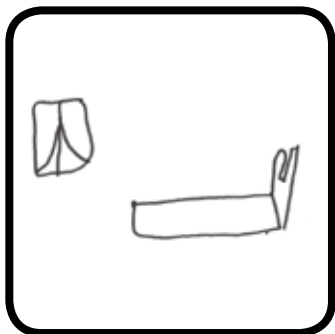
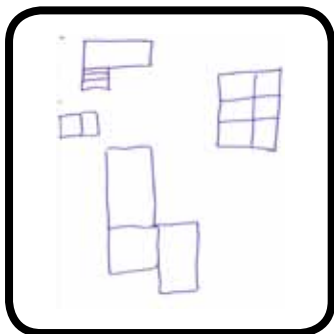
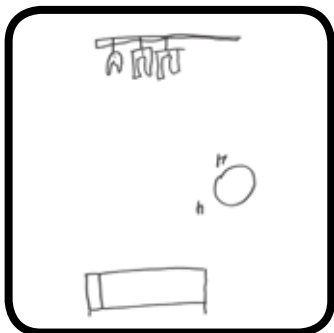
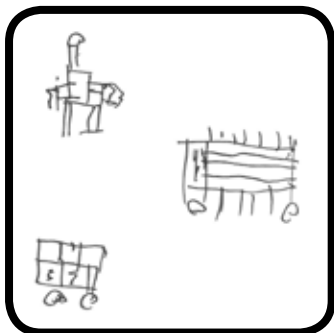

CONCLUSIONES:

CENTRO DE PROMOCIÓN DE AUTONOMÍA PERSONAL - BERGONDO

REFERENTE: DESPACHO MÉDICO

GRUPO: USUARIOS

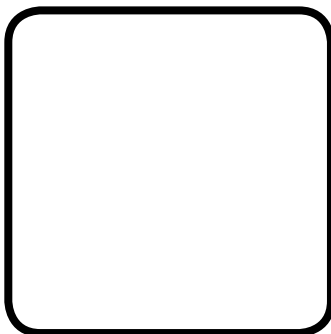
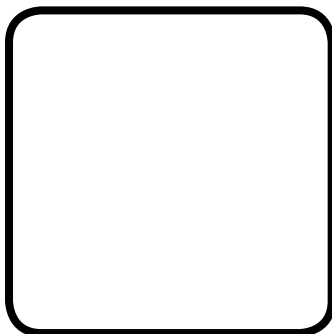
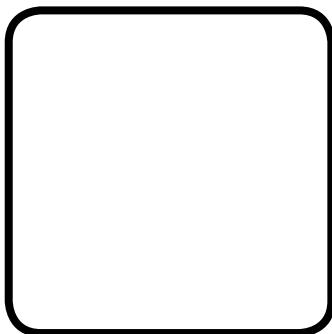
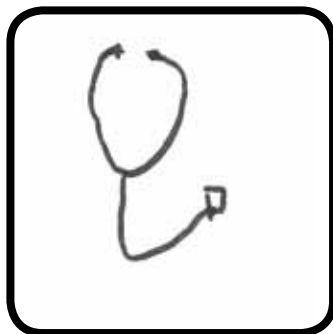
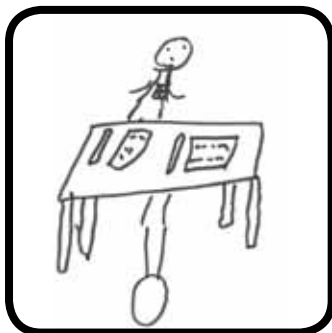
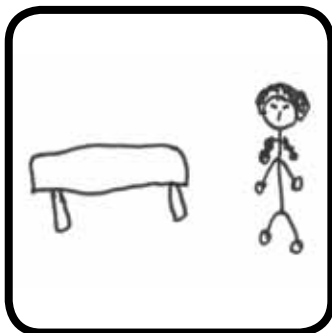
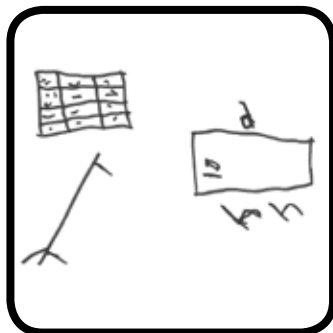
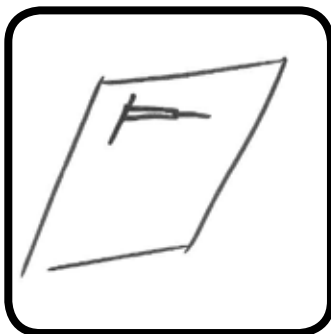
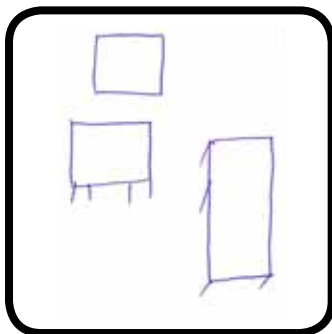
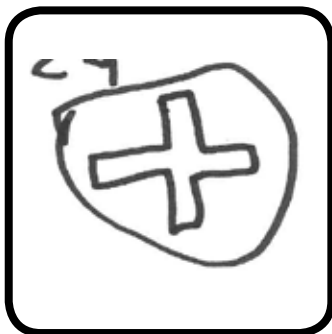
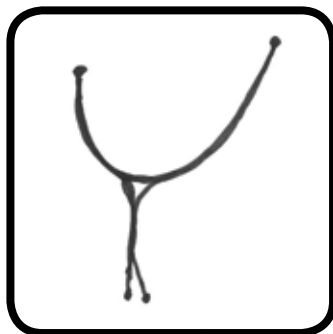
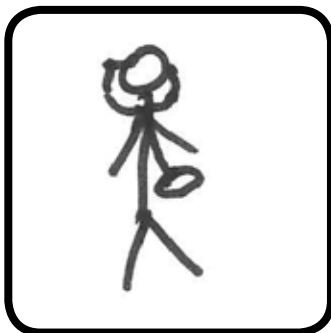
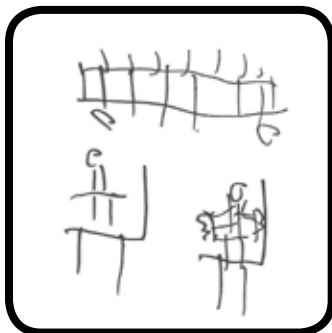
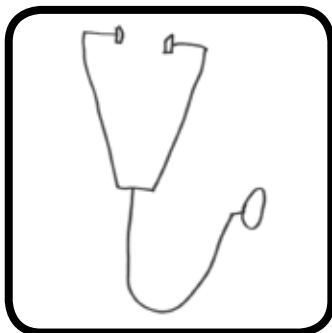
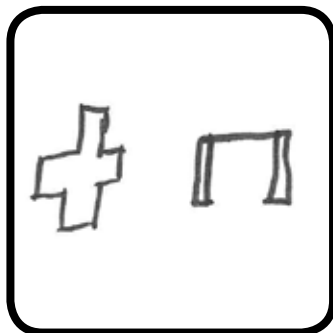

CONCLUSIONES:

CENTRO DE PROMOCIÓN DE AUTONOMÍA PERSONAL - BERGONDO

REFERENTE: RESPONSABLE ÁREA TÉCNICA

GRUPO: USUARIOS

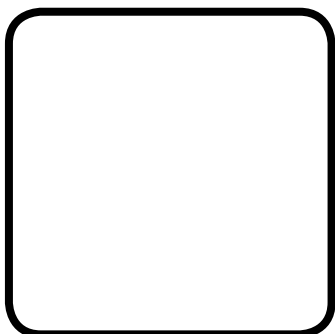
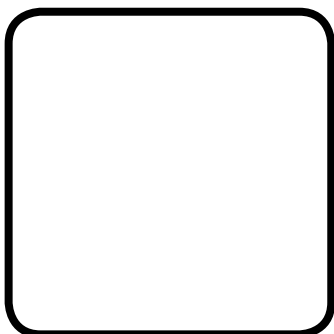
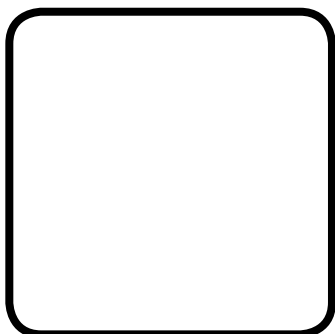
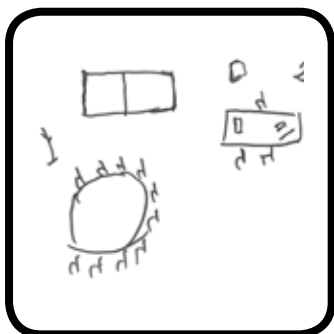
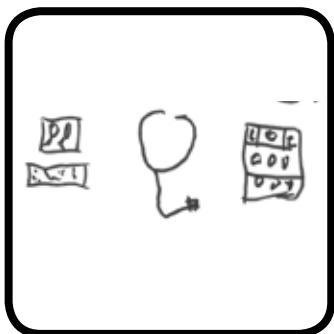
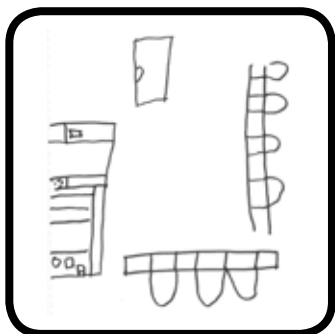
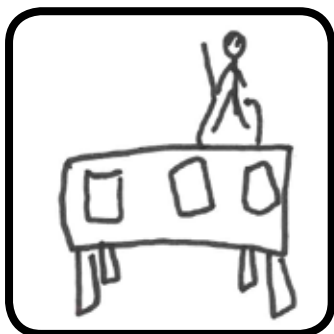
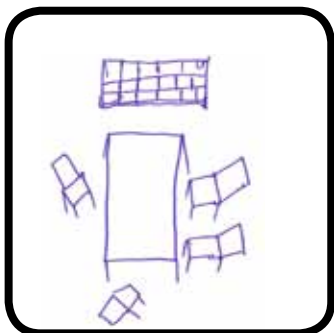
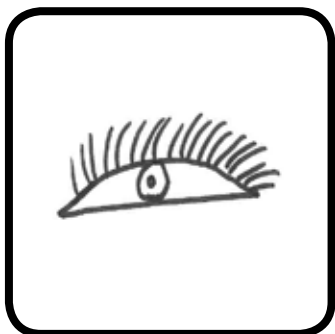
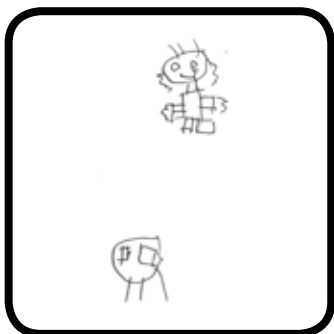

CONCLUSIONES:

CENTRO DE PROMOCIÓN DE AUTONOMÍA PERSONAL - BERGONDO

REFERENTE: DESPACHO DE NEUROPSICÓLOGA

GRUPO: USUARIOS

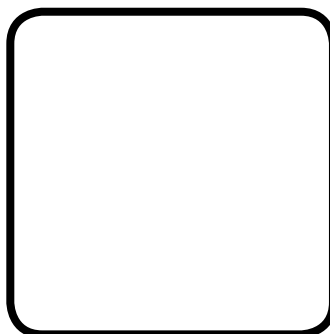
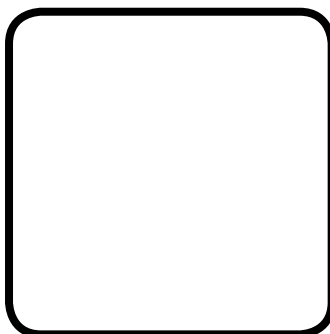
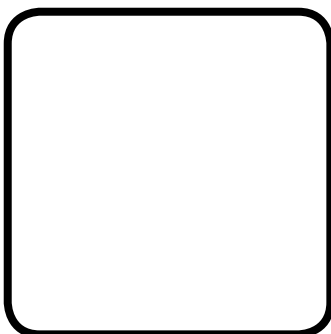
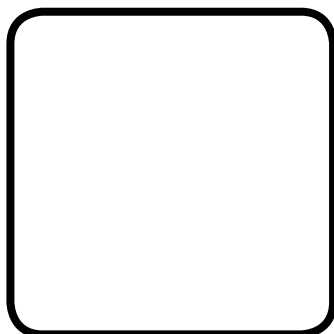
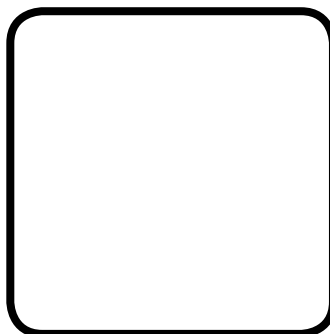
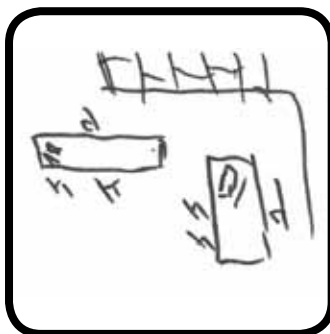
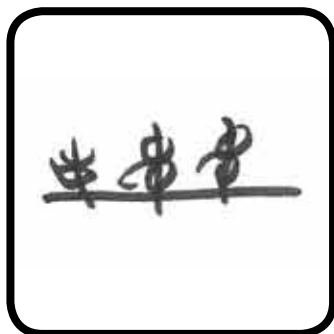
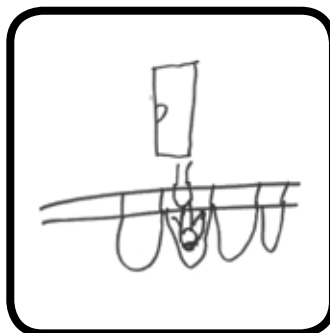
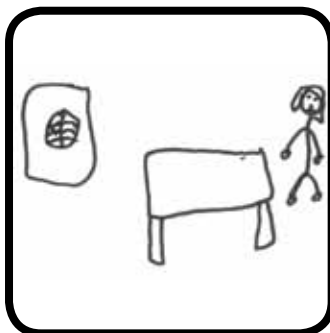
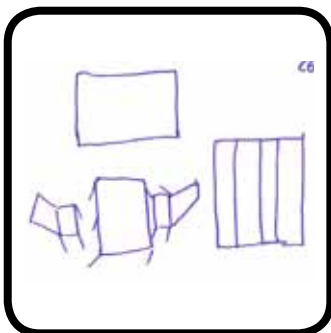
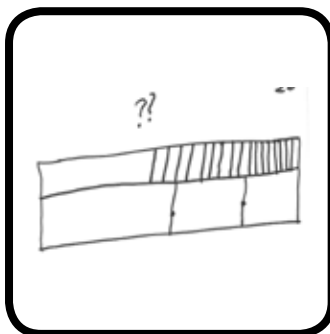
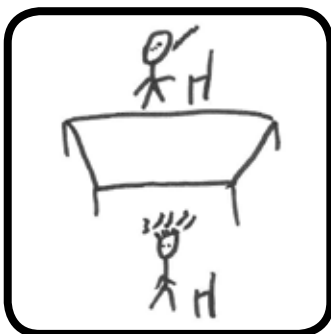
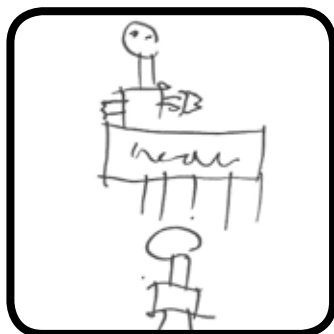

CONCLUSIONES:

CENTRO DE PROMOCIÓN DE AUTONOMÍA PERSONAL - BERGONDO

REFERENTE: DESPACHO MÉDICO REHABILITADOR

GRUPO: USUARIOS

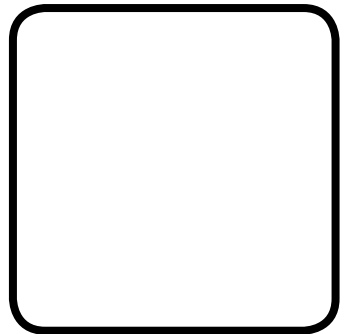
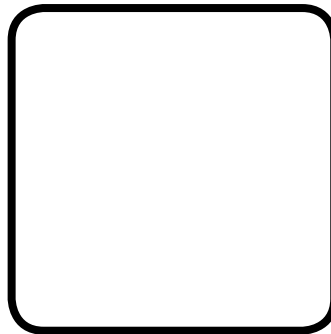
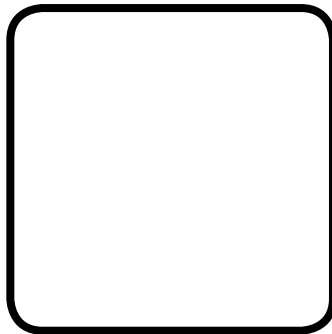
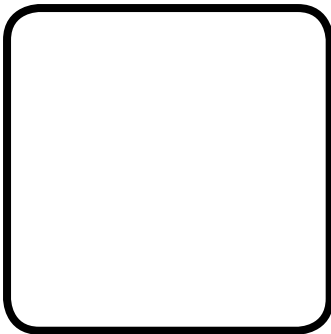
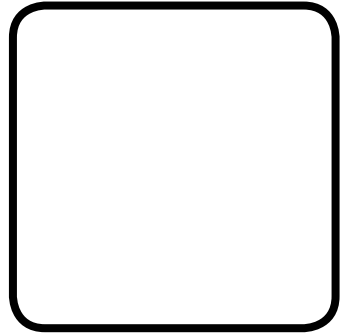
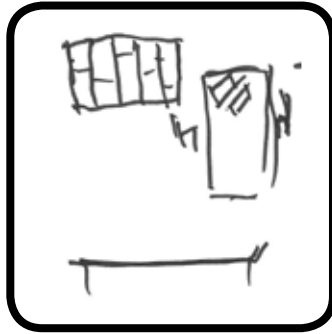
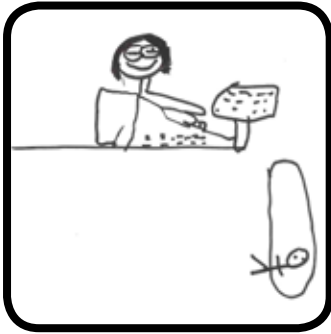
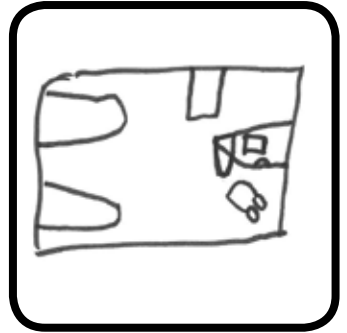
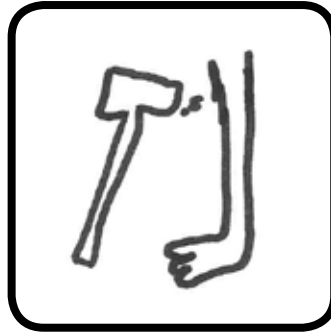
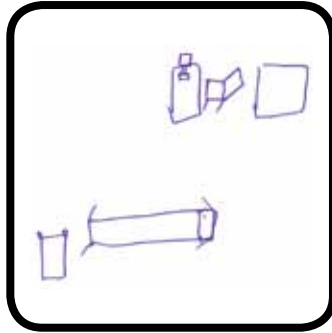
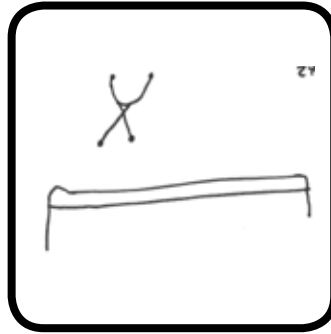
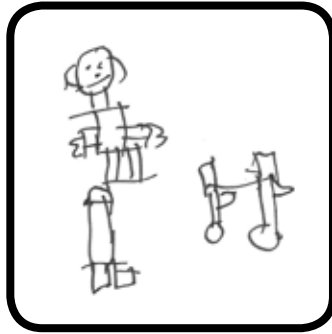
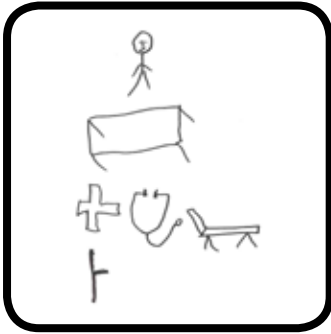

CONCLUSIONES:

CENTRO DE PROMOCIÓN DE AUTONOMÍA PERSONAL - BERGONDO

REFERENTE: VIVIENDA ADAPTADA	GRUPO: USUARIOS
------------------------------	-----------------

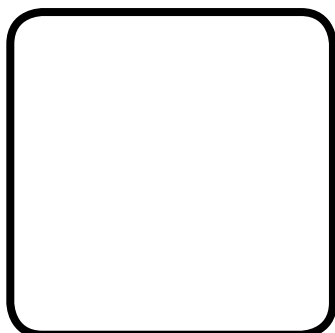
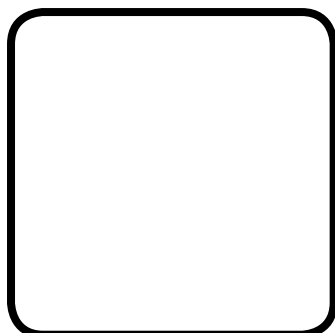
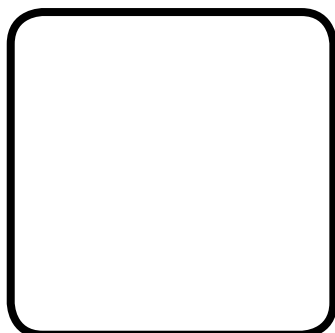
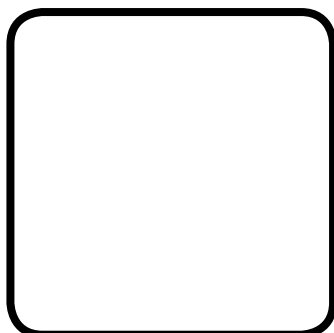
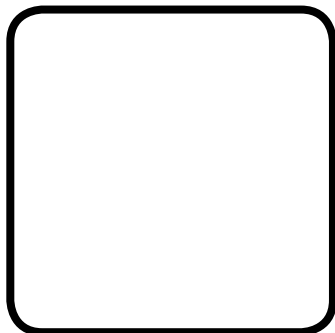
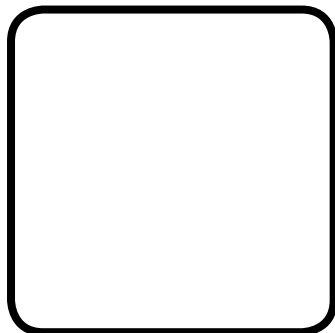
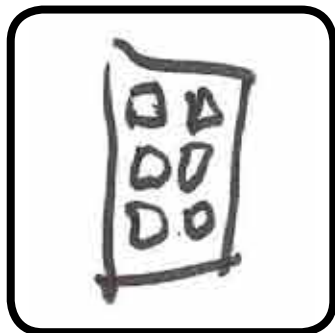
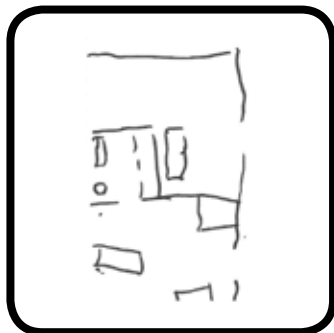
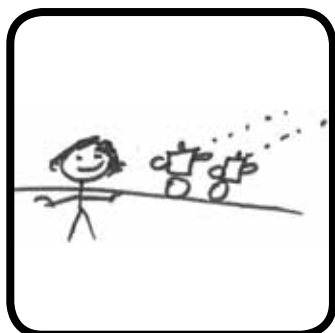
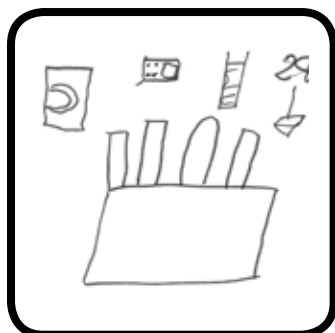
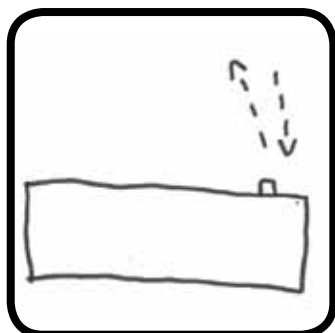
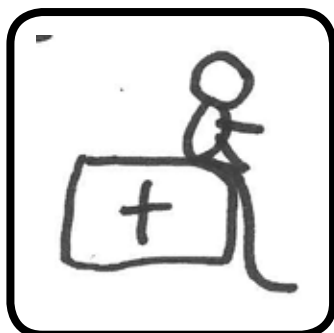
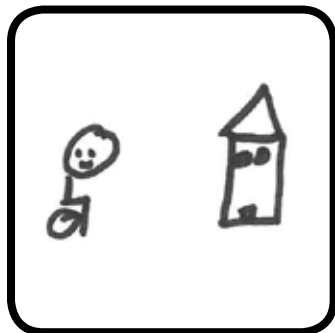
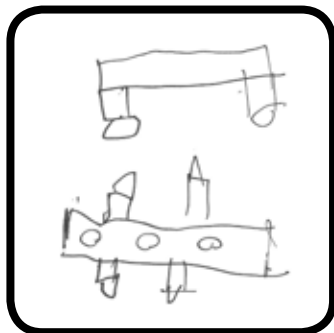

CONCLUSIONES:

CENTRO DE PROMOCIÓN DE AUTONOMÍA PERSONAL - BERGONDO

REFERENTE: TALLER ACTIVIDADES VIDA DIARIA

GRUPO: USUARIOS

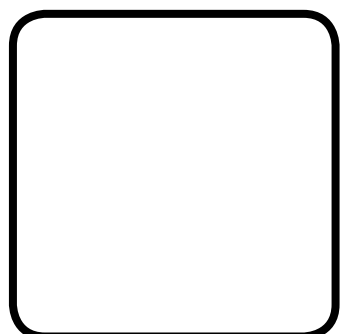
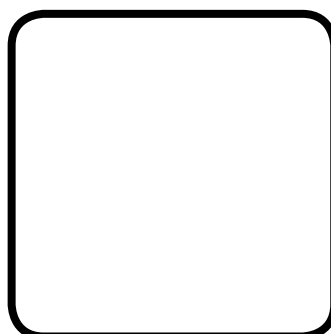
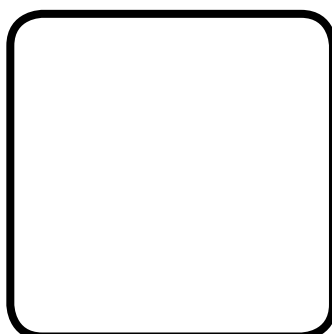
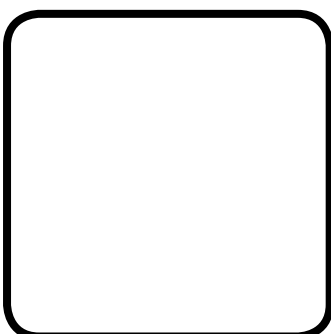
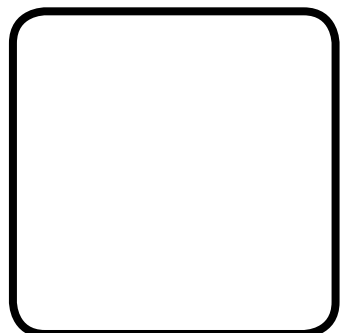
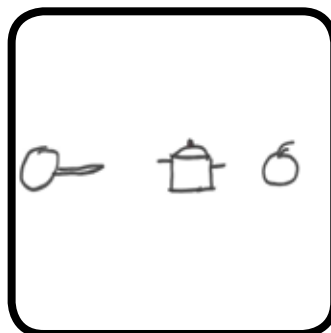
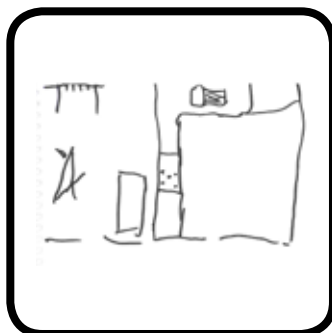
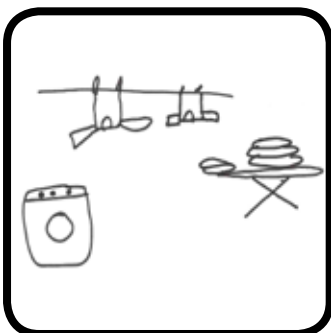
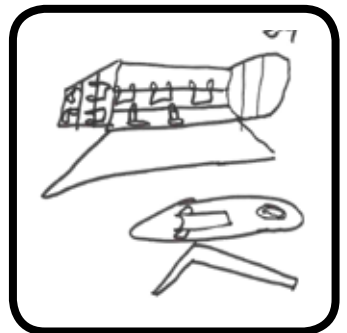
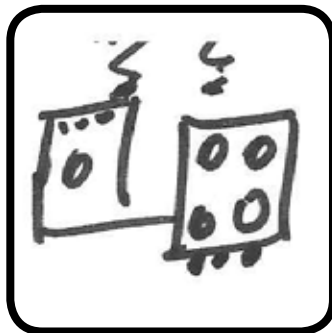
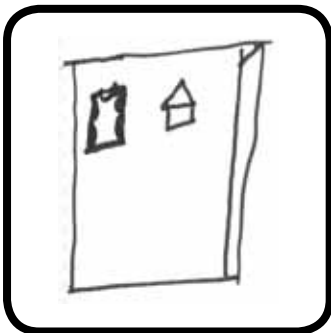
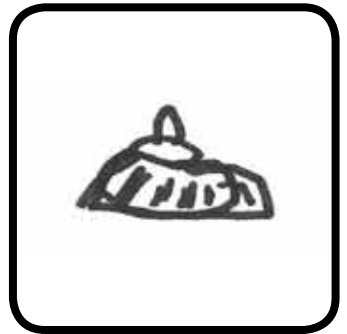
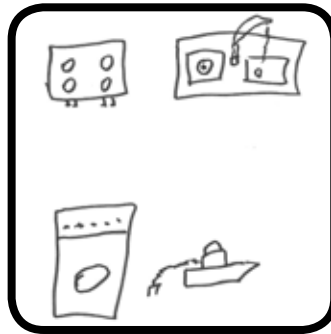
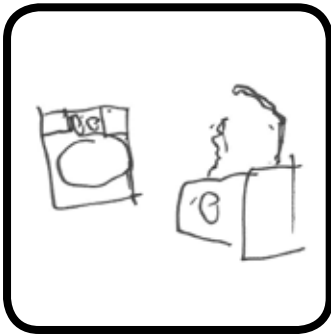

CONCLUSIONES:

CENTRO DE PROMOCIÓN DE AUTONOMÍA PERSONAL - BERGONDO

REFERENTE:
SALA DE EXPOSICIÓN DE PRODUCTOS DE APOYO

GRUPO: USUARIOS

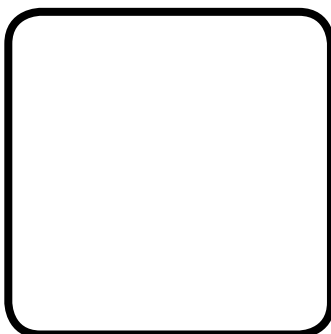
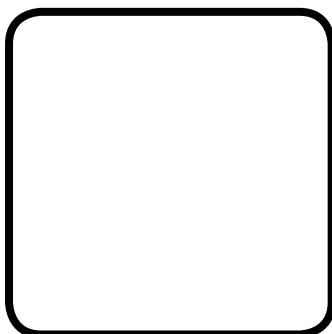
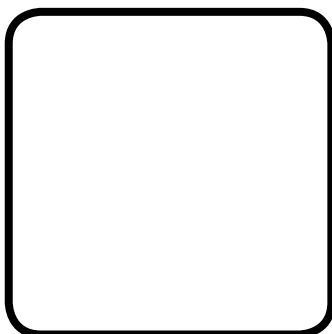
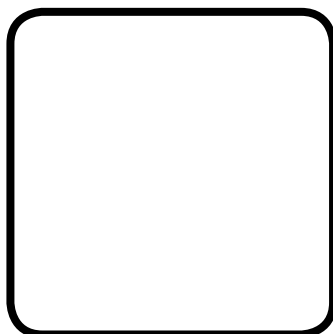
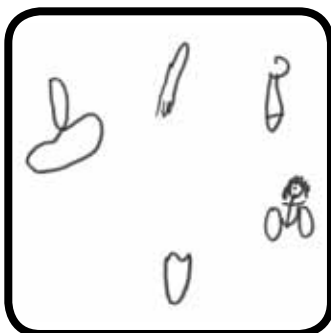
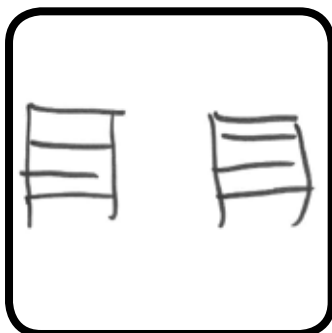
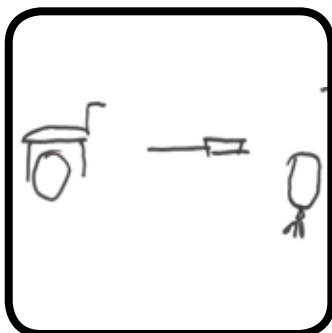
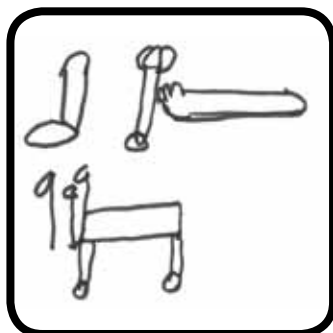
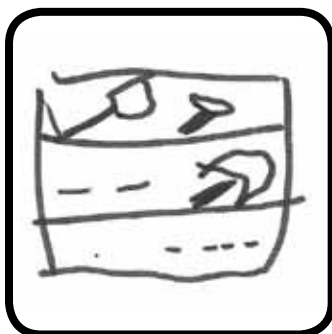
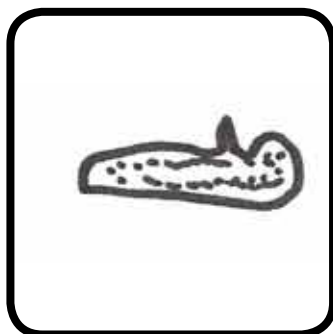
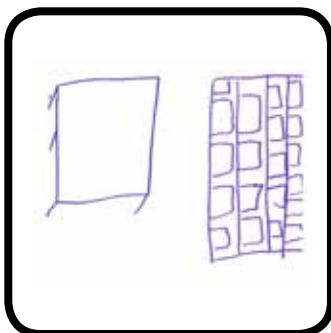
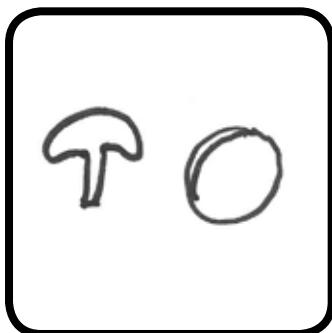
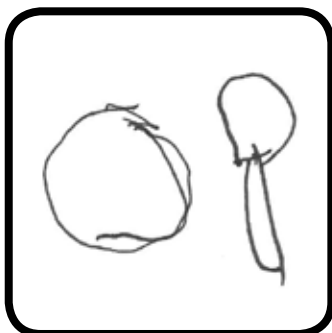
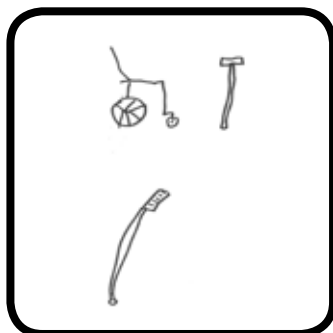

CONCLUSIONES:

CENTRO DE PROMOCIÓN DE AUTONOMÍA PERSONAL - BERGONDO

REFERENTE: ALMACÉN

GRUPO: USUARIOS

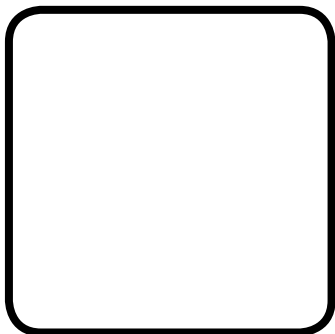
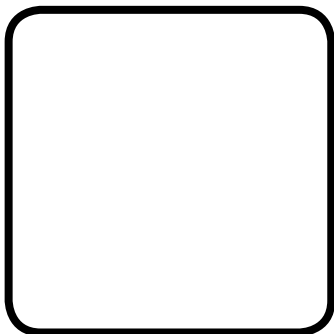
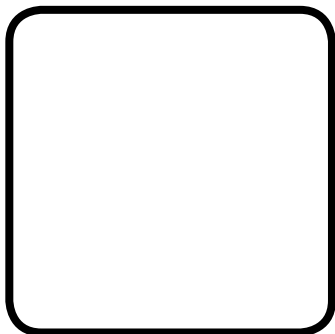
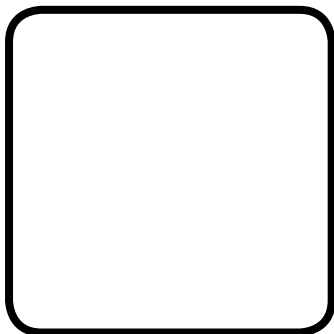
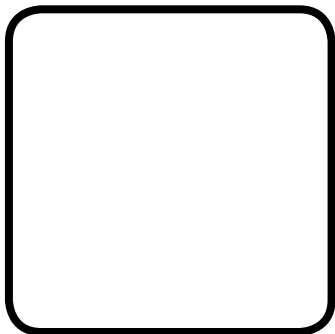
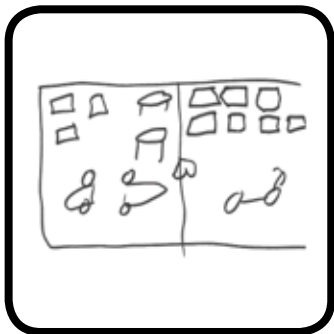
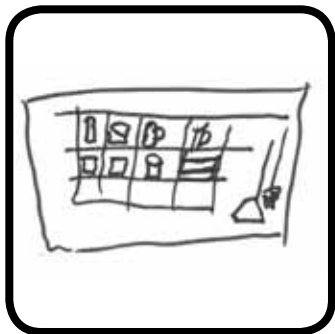
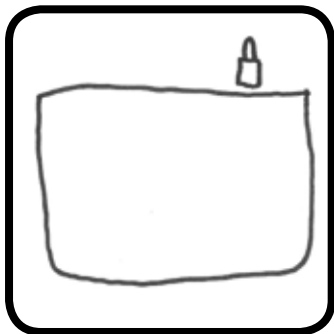
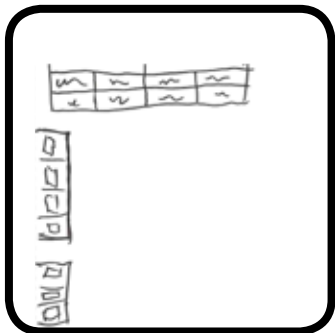
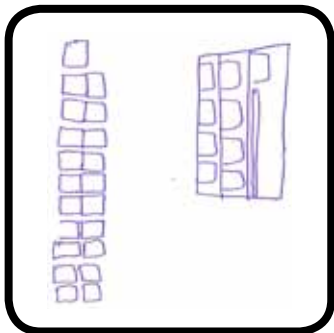
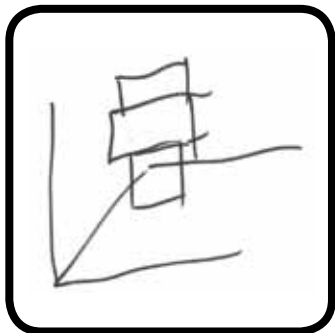
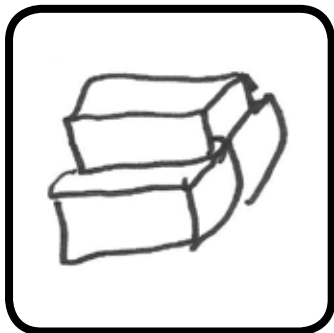
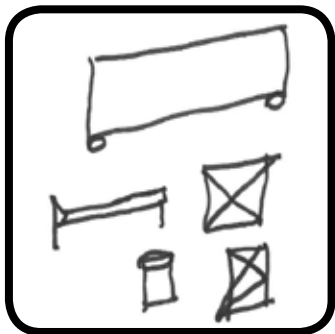
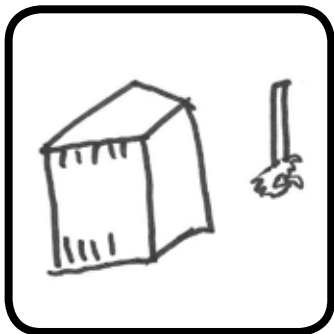
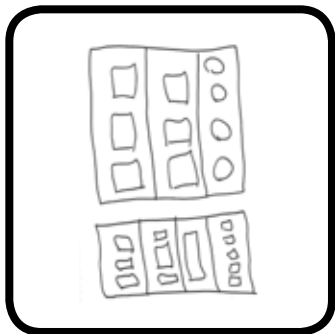

CONCLUSIONES:

CENTRO DE PROMOCIÓN DE AUTONOMÍA PERSONAL - BERGONDO

REFERENTE: COMEDOR EMPLEADOS

GRUPO: USUARIOS

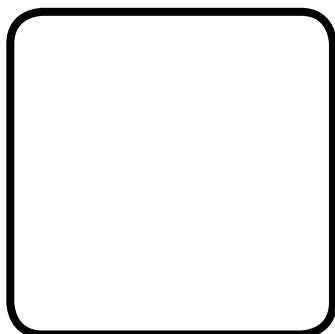
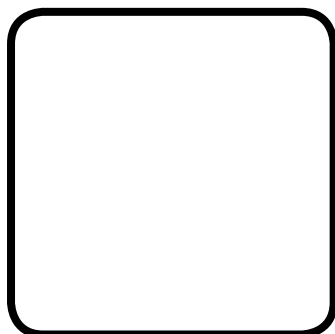
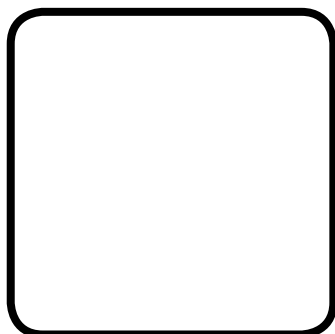
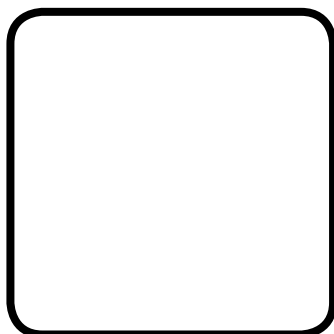
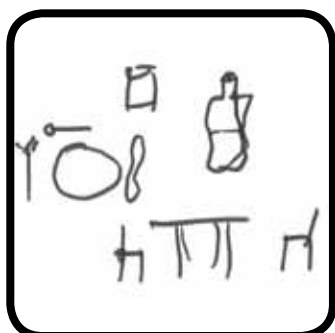
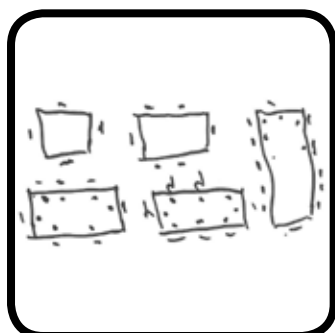
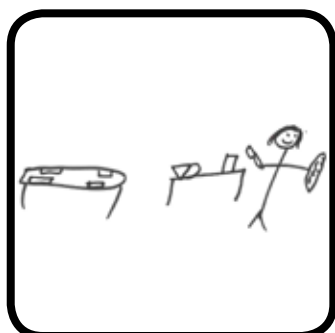
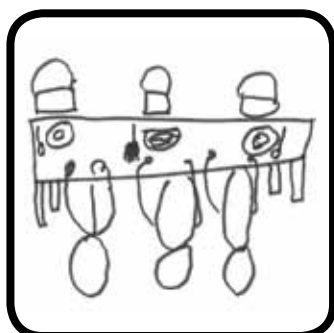
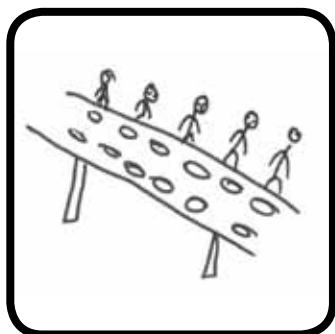
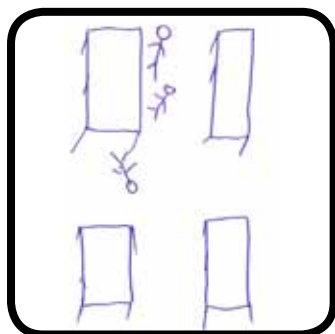
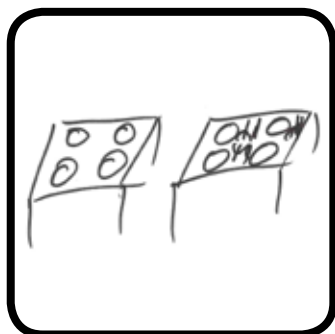
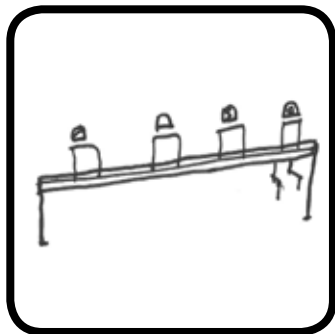
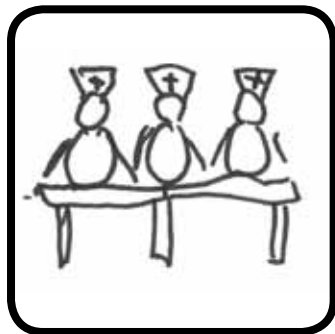
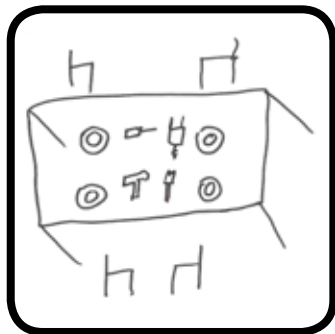
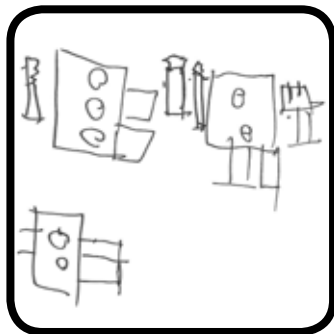

CONCLUSIONES:

CENTRO DE PROMOCIÓN DE AUTONOMÍA PERSONAL - BERGONDO

REFERENTE: DESPACHO DE ADMINISTRACIÓN

GRUPO: USUARIOS

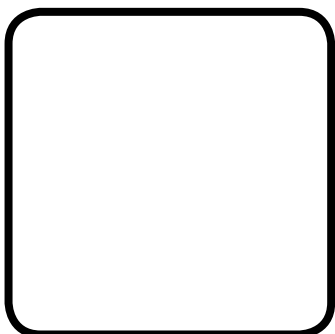
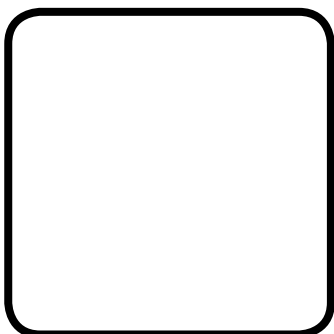
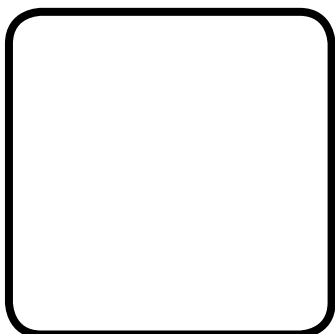
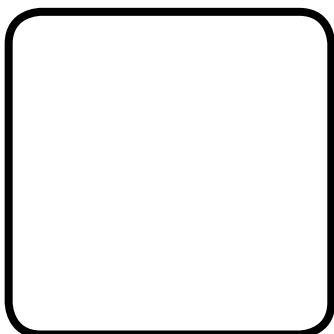
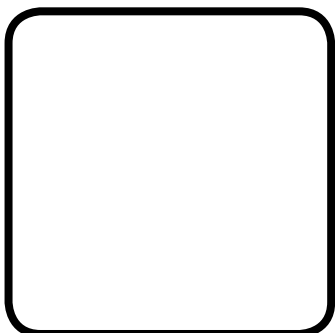
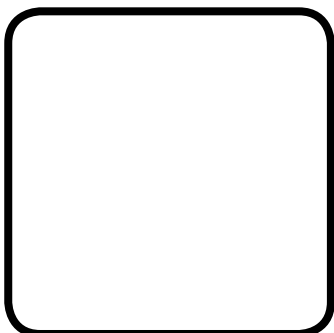
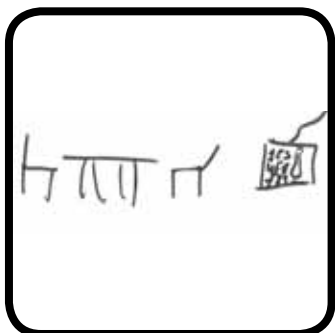
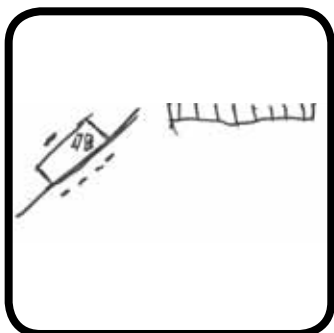
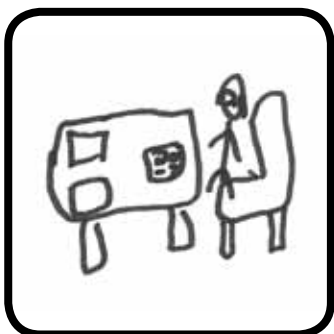
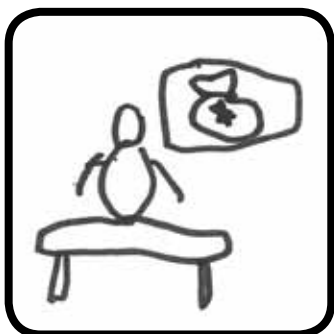
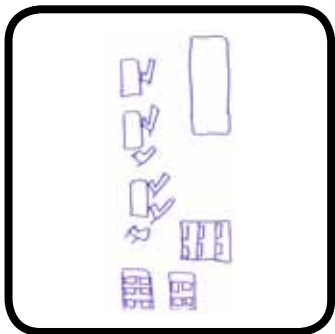
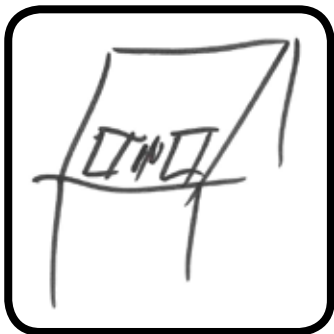
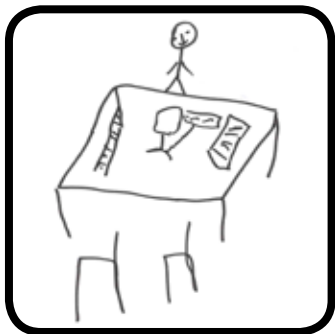
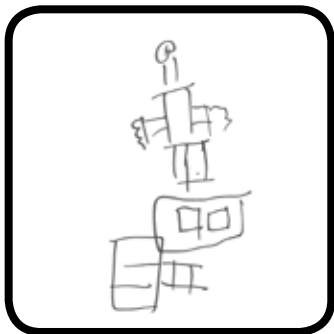

CONCLUSIONES:

CENTRO DE PROMOCIÓN DE AUTONOMÍA PERSONAL - BERGONDO

REFERENTE: **DESPACHO GOBERNANTA**

GRUPO: **USUARIOS**

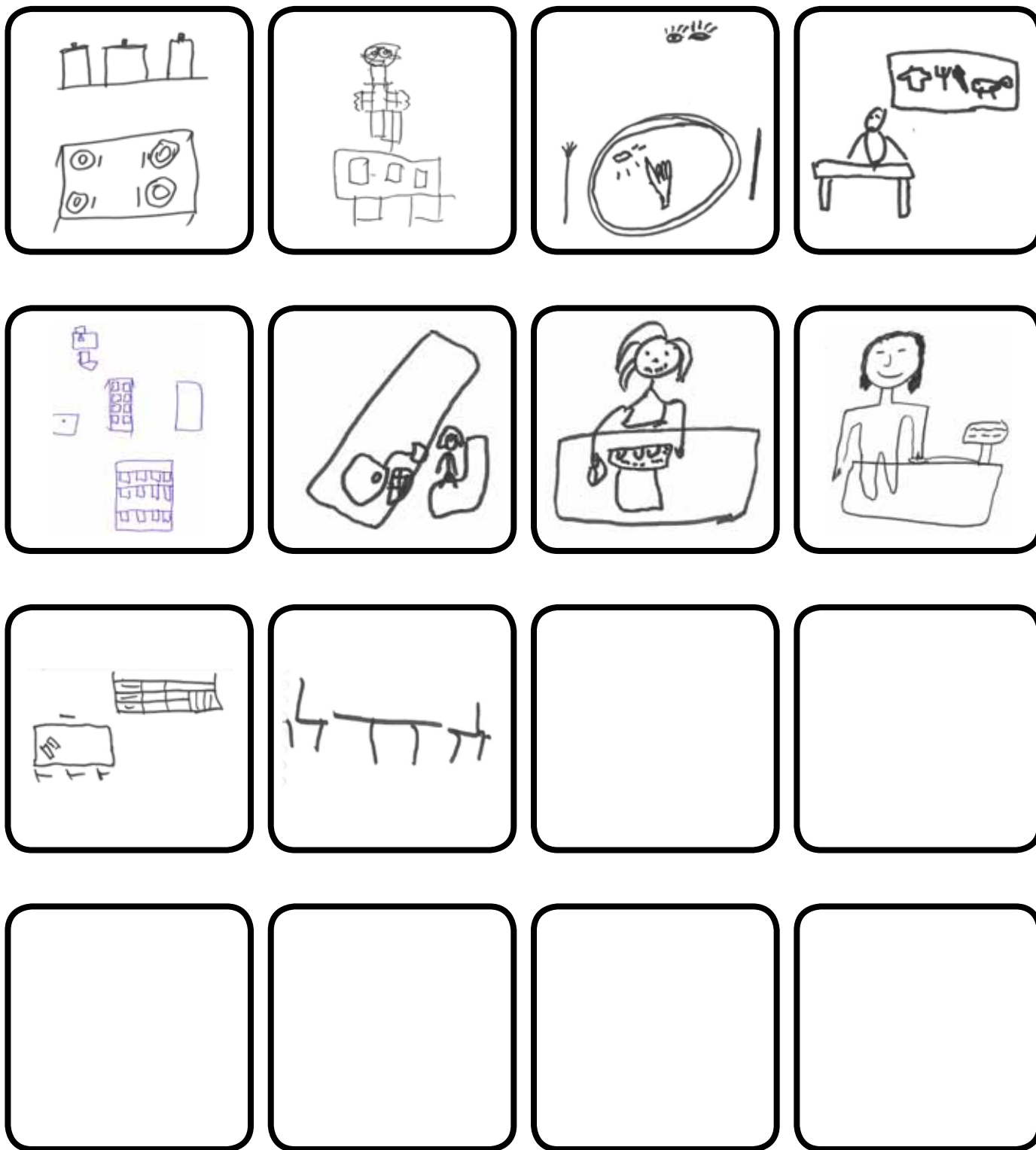

CONCLUSIONES:

CENTRO DE PROMOCIÓN DE AUTONOMÍA PERSONAL - BERGONDO

REFERENTE: DESPACHO JEFE DE ALMACÉN

GRUPO: USUARIOS

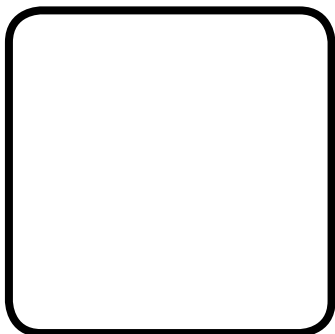
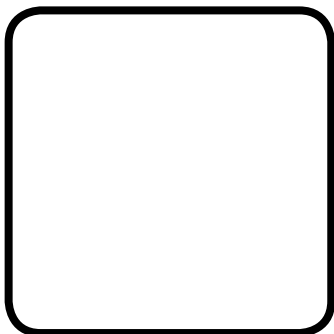
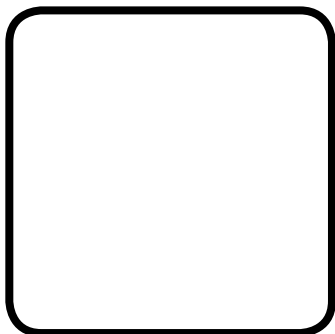
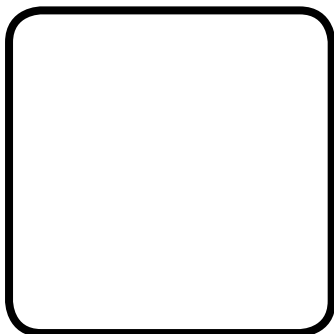
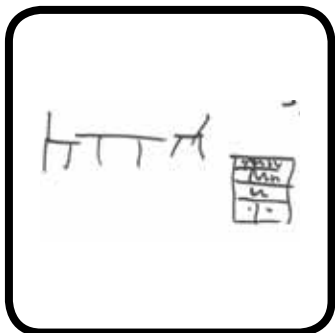
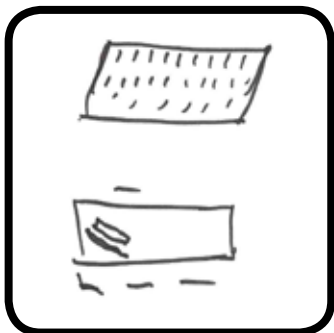
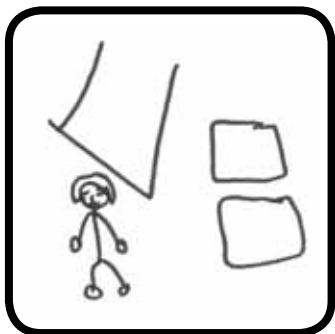
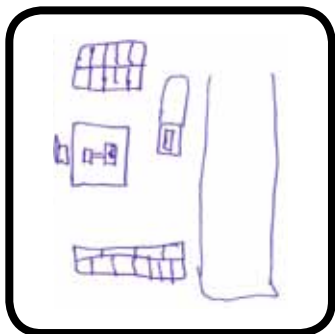
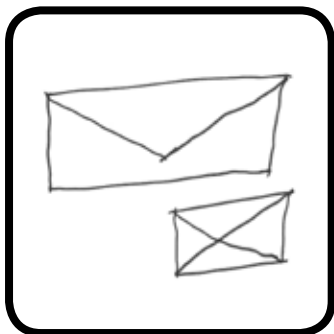
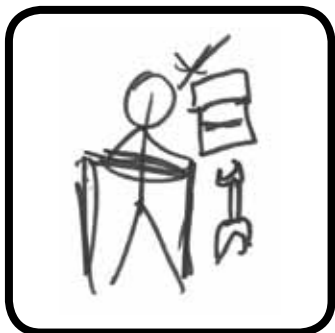
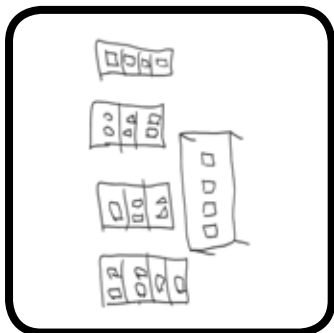

CONCLUSIONES:

CENTRO DE PROMOCIÓN DE AUTONOMÍA PERSONAL - BERGONDO

REFERENTE: LAVANDERÍA

GRUPO: USUARIOS

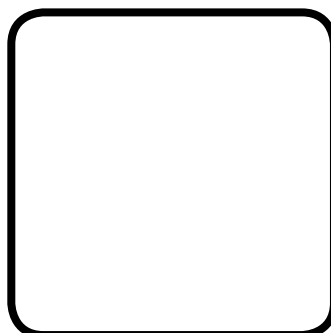
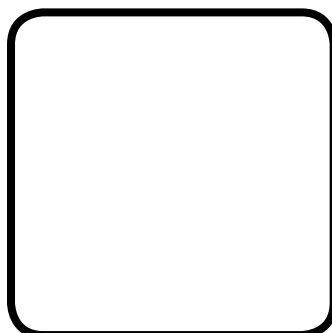
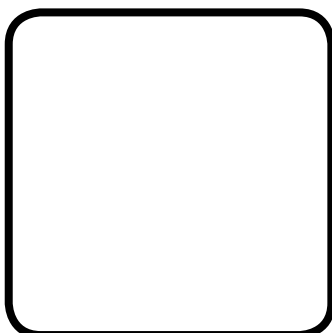
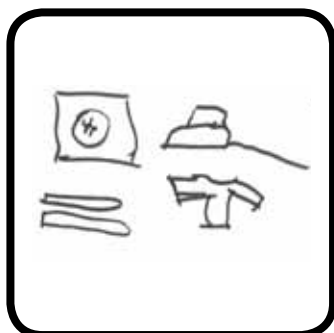
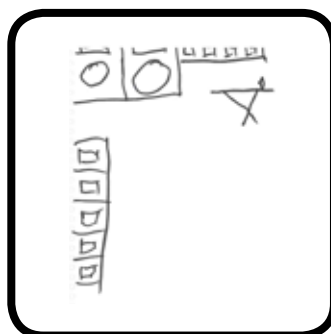
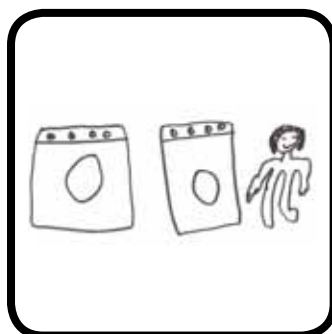
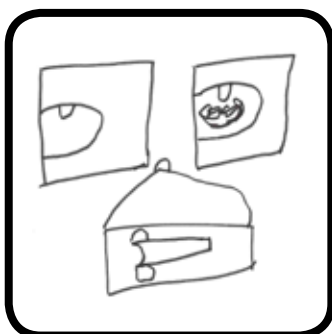
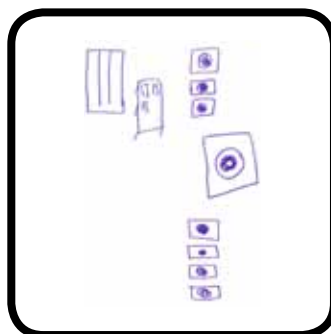
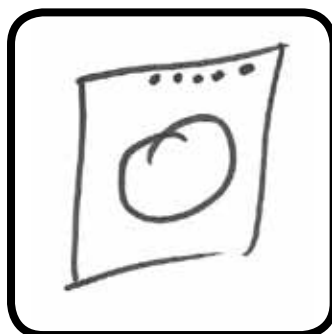
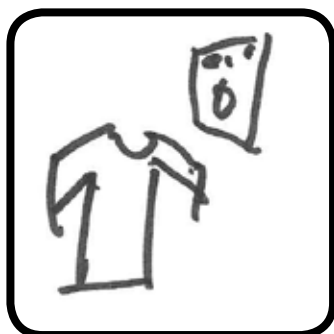
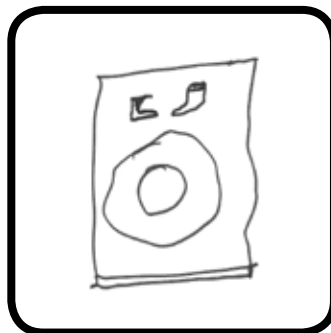
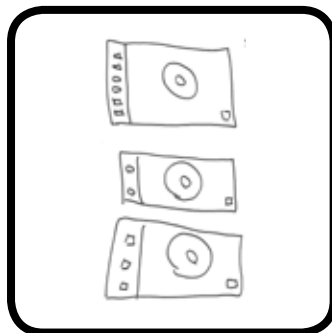
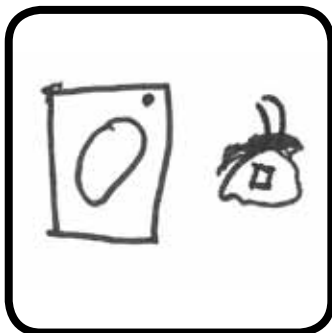
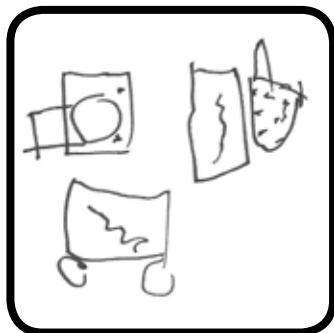

CONCLUSIONES:

CENTRO DE PROMOCIÓN DE AUTONOMÍA PERSONAL - BERGONDO

REFERENTE: MANTENIMIENTO

GRUPO: USUARIOS

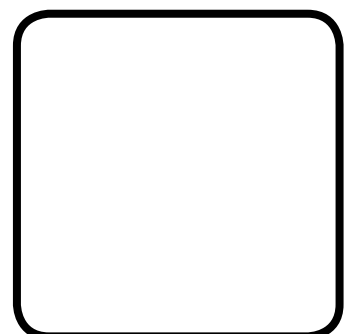
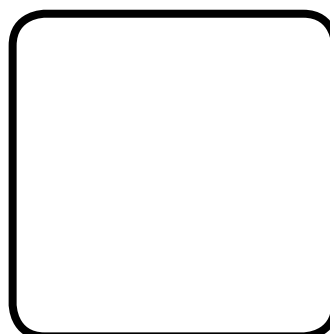
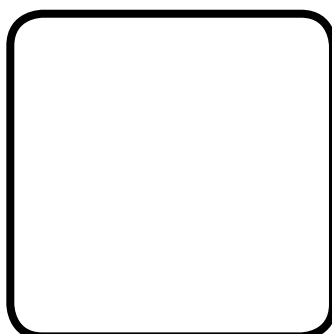
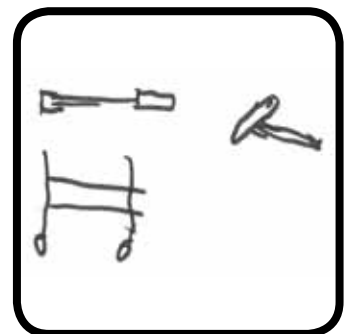
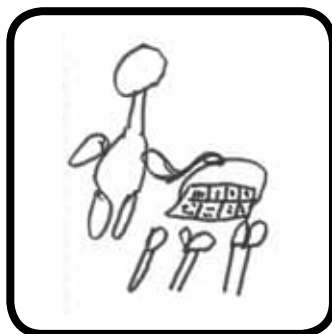
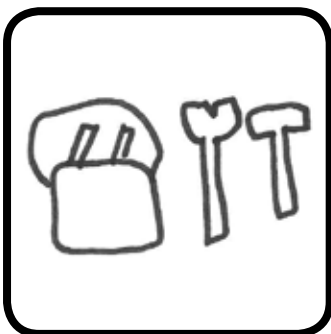
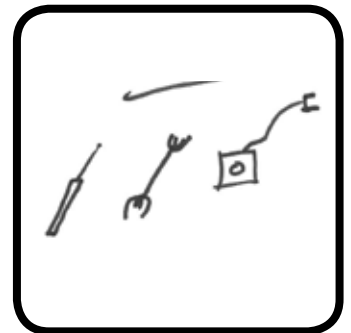
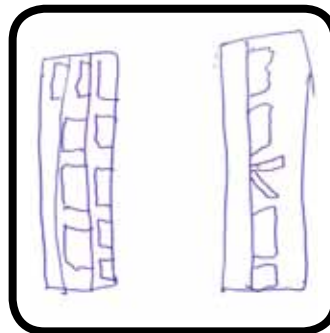
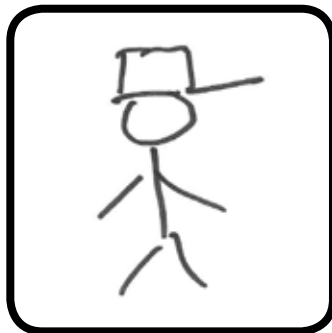
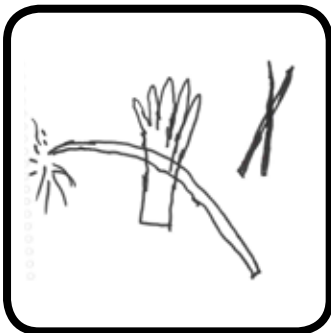
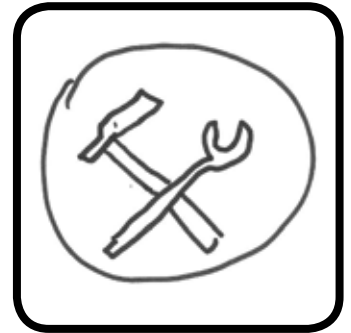
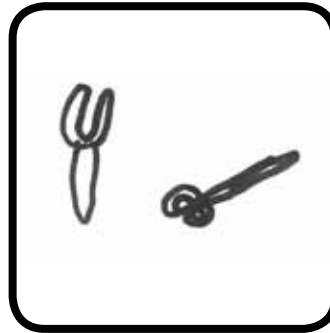
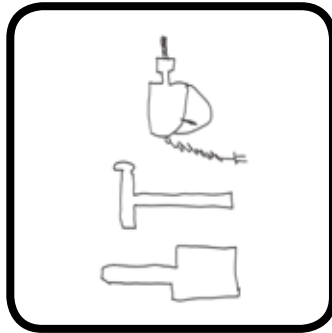
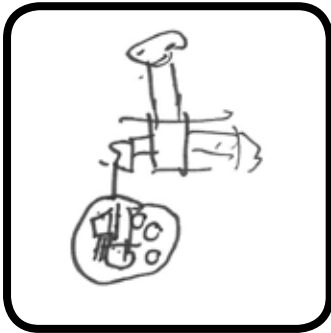

CONCLUSIONES:

CENTRO DE PROMOCIÓN DE AUTONOMÍA PERSONAL - BERGONDO

REFERENTE: **COCINA**

GRUPO: **USUARIOS**

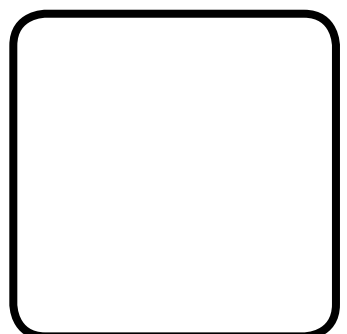
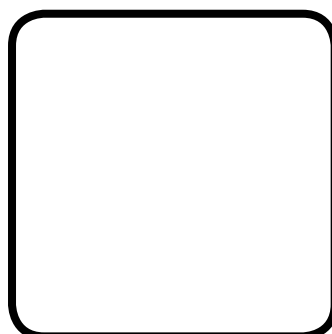
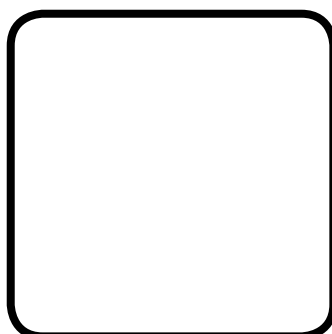
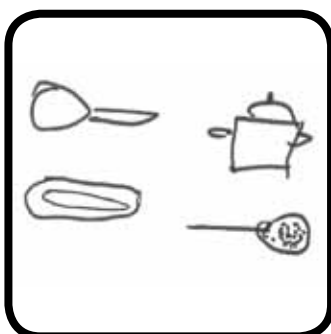
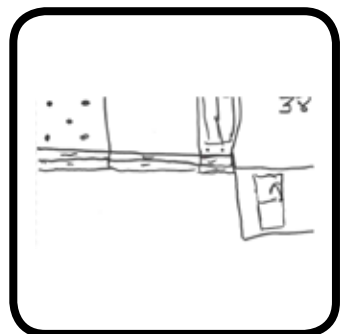
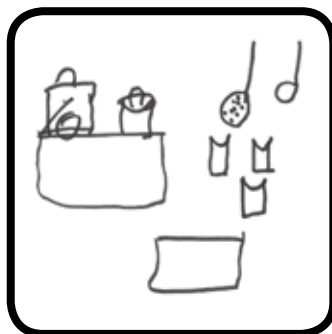
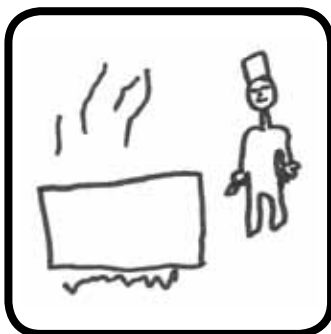
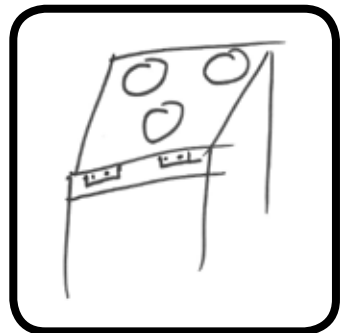
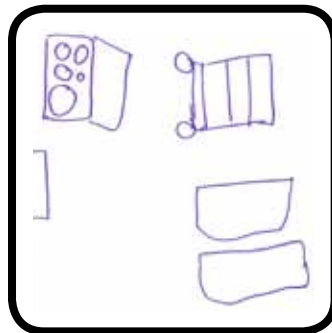
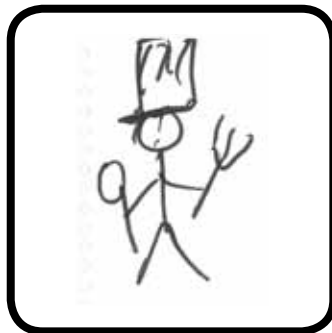
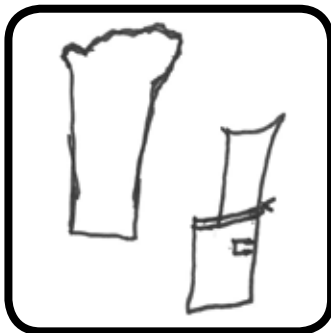
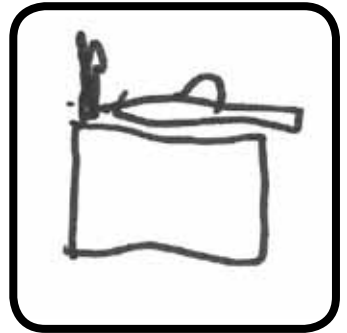
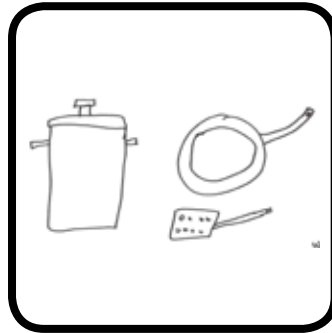
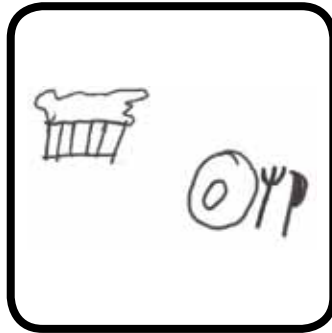
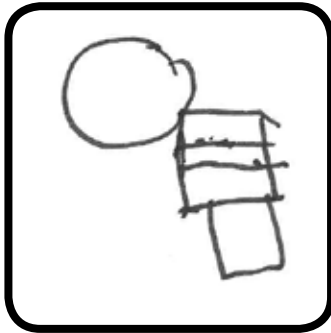

CONCLUSIONES:

CENTRO DE PROMOCIÓN DE AUTONOMÍA PERSONAL - BERGONDO

REFERENTE: VESTUARIO FEMENINO

GRUPO: USUARIOS

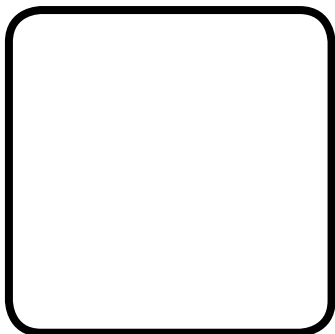
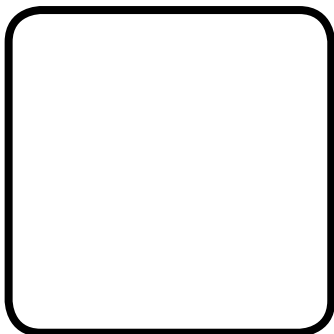
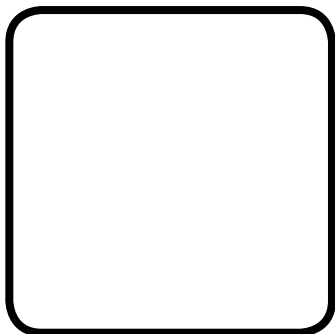
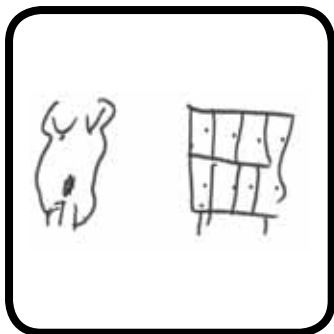
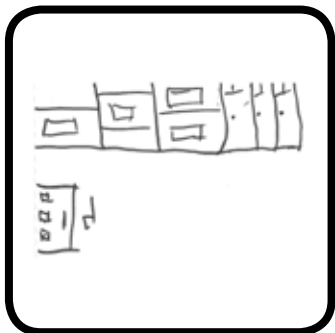
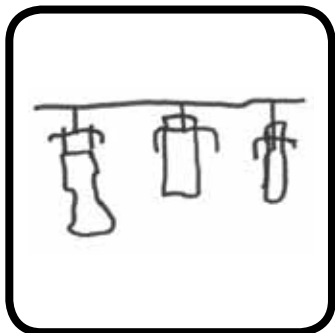
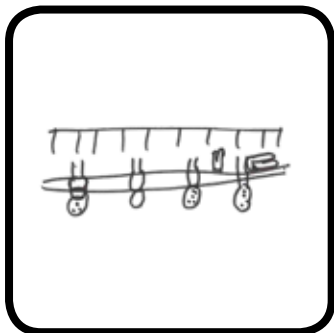
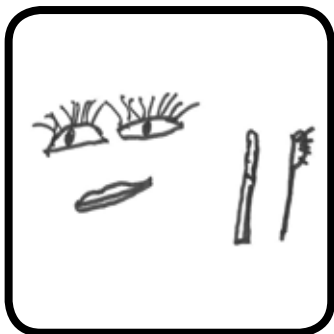
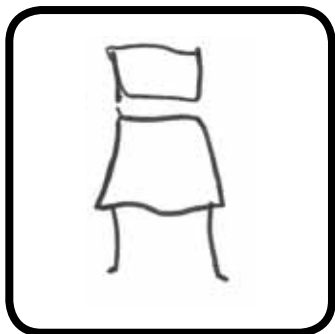
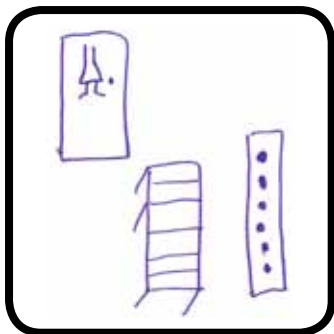
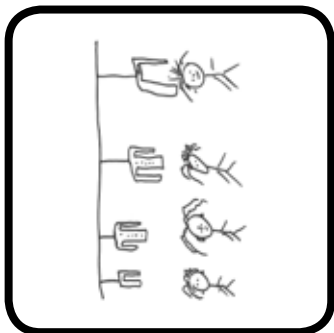
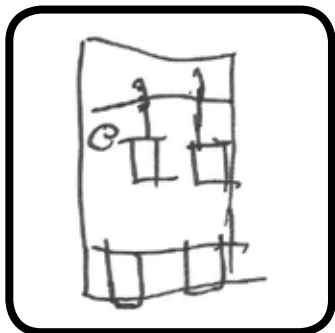
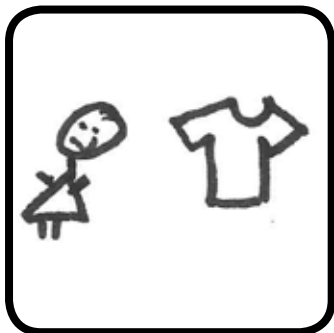

CONCLUSIONES:

CENTRO DE PROMOCIÓN DE AUTONOMÍA PERSONAL - BERGONDO

REFERENTE: VESTUARIO MASCULINO

GRUPO: USUARIOS

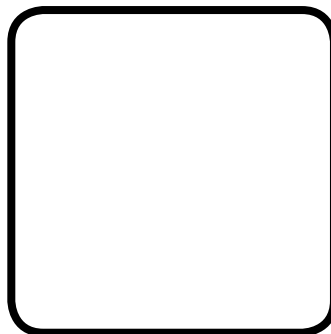
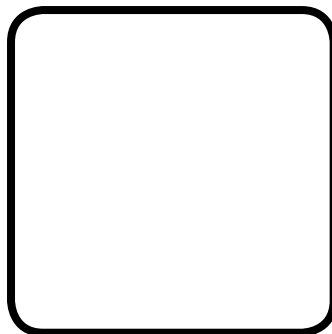
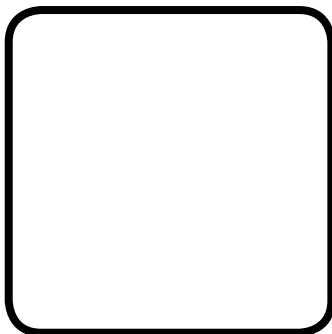
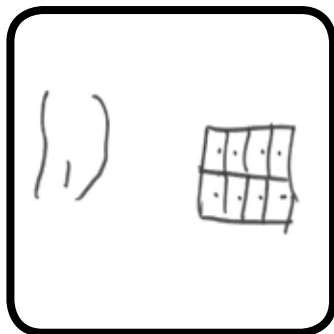
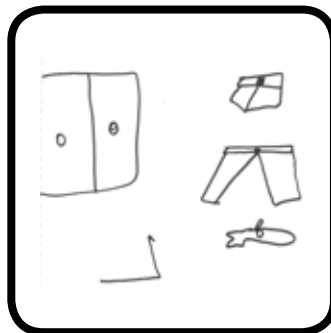
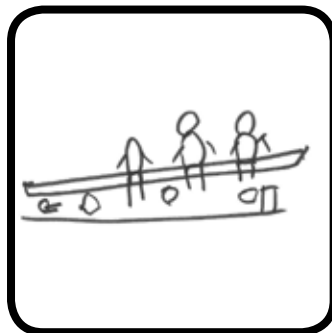
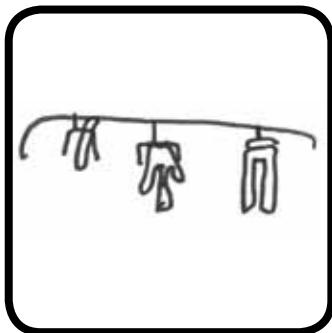
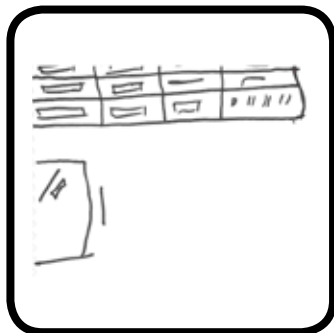
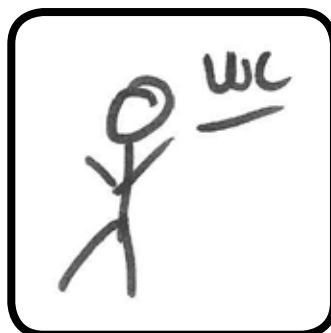
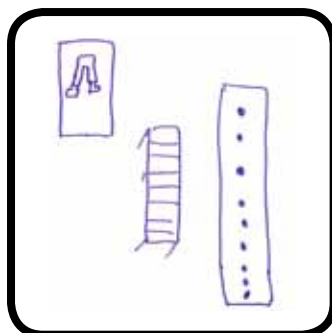
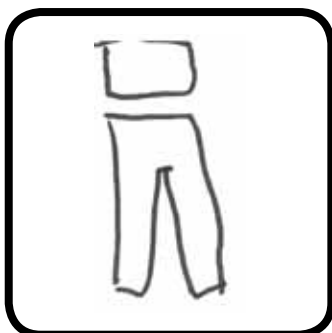
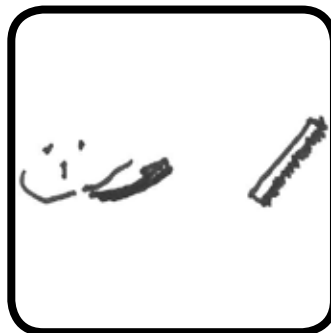
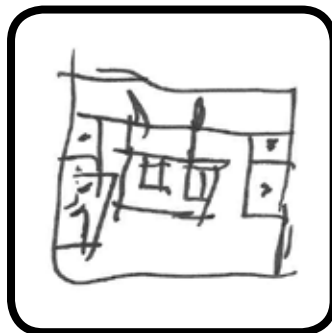
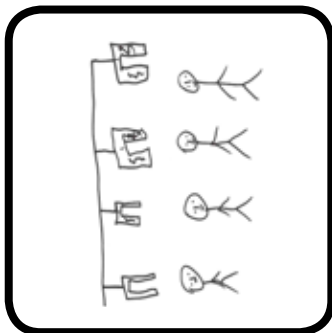
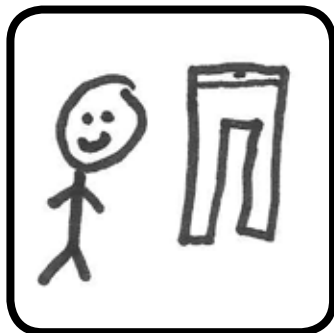

CONCLUSIONES:

CRE

LOCALIDAD: SAN ANDRÉS DEL RABANEDO

GRUPO: PROFESIONALES

CRE - SAN ANDRÉS DEL RABANEDO

REFERENTE: AULA DE DEPORTE

GRUPO: PROFESIONALES

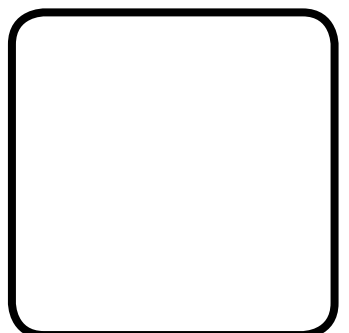
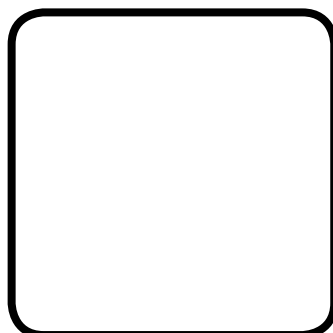
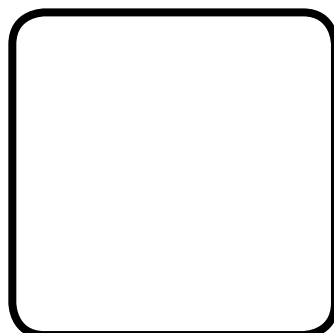
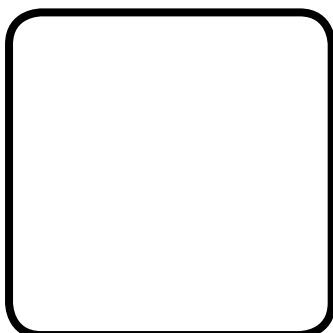
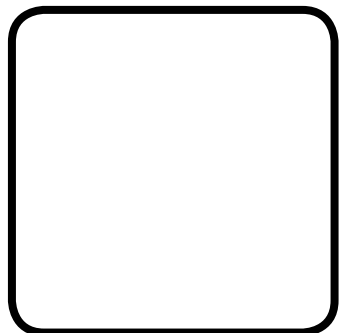
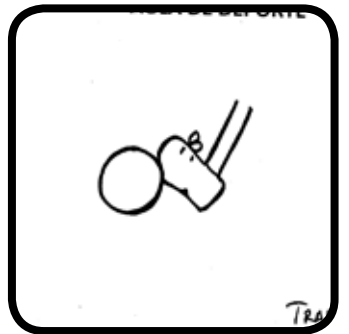
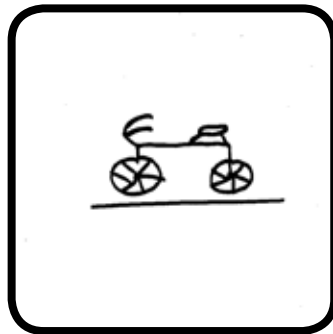
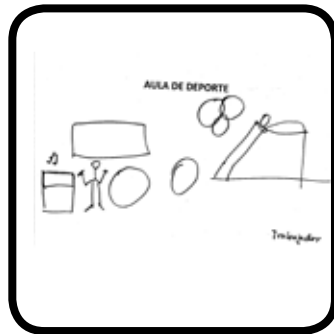
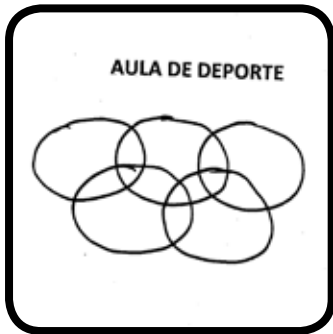
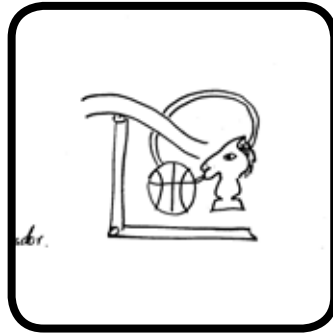

CONCLUSIONES:

CRE - SAN ANDRÉS DEL RABANEDO

REFERENTE: AULA DE EDUCACIÓN SOCIAL

GRUPO: PROFESIONALES

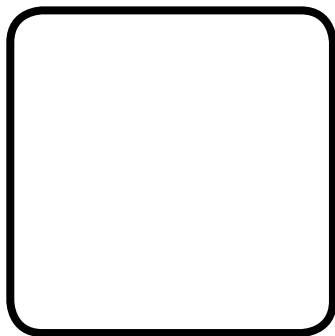
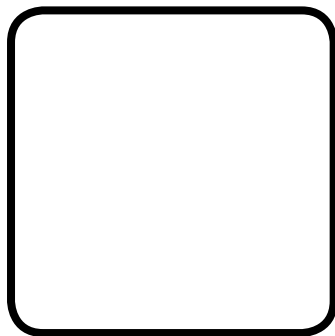
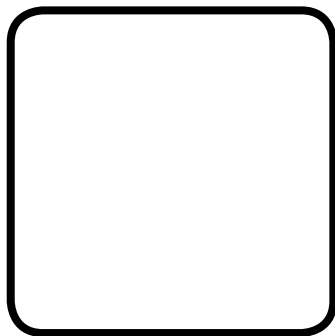
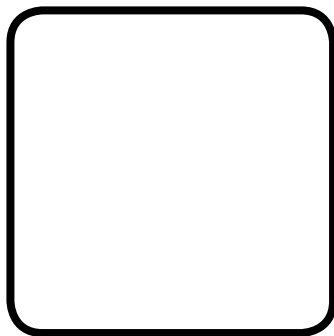
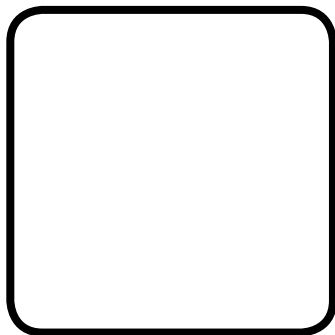
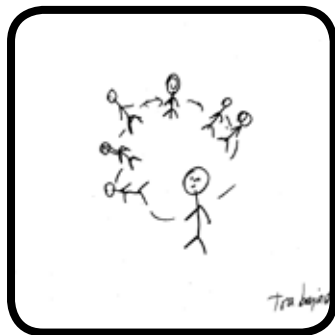
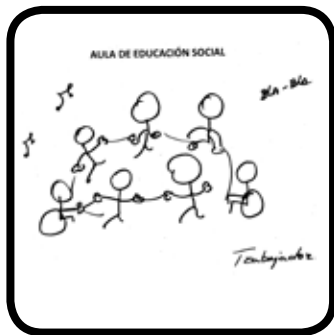
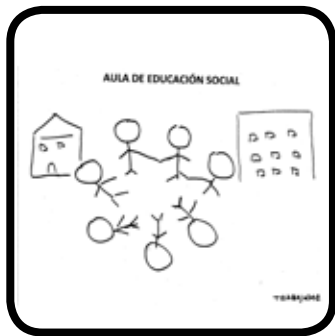
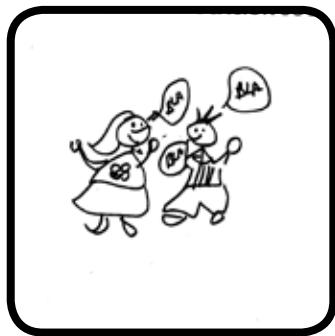
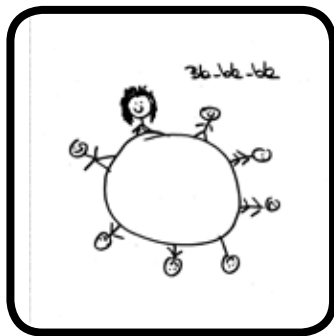

CONCLUSIONES:

CRE - SAN ANDRÉS DEL RABANEDO

REFERENTE: INFORMÁTICA

GRUPO: PROFESIONALES

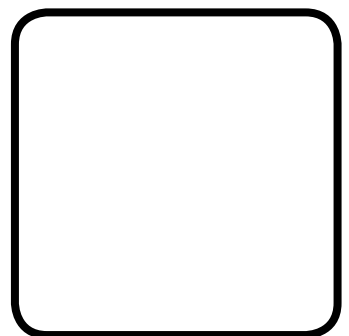
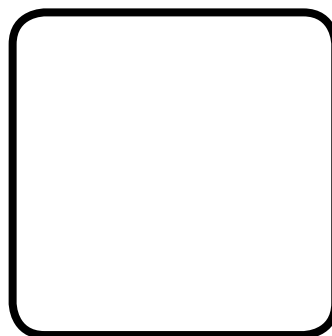
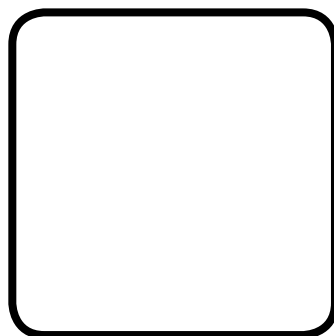
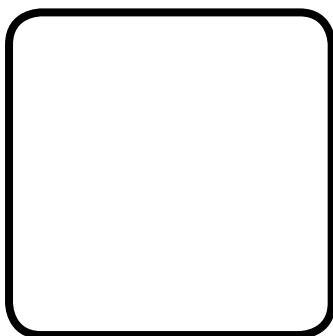
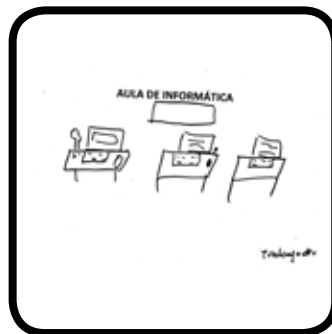

CONCLUSIONES:

CRE - SAN ANDRÉS DEL RABANEDO

REFERENTE: AULA DE LOGOPEDIA

GRUPO: PROFESIONALES

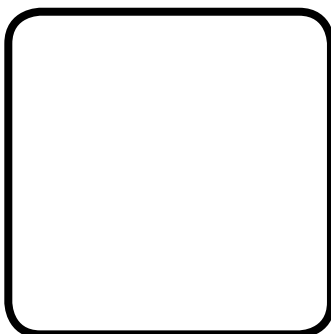
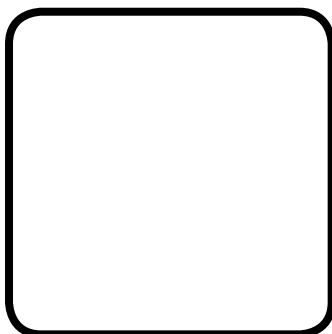
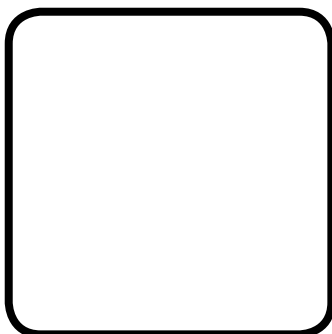
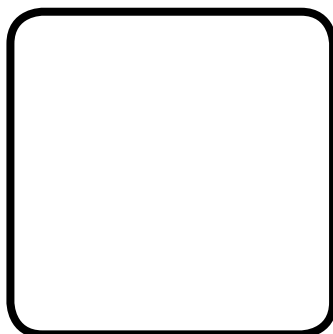
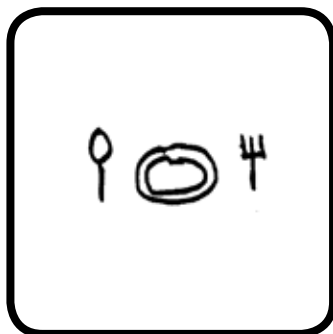
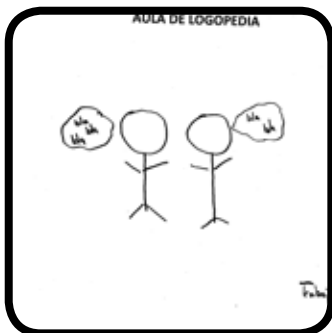









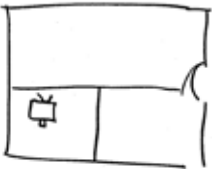

CONCLUSIONES:

CRE - SAN ANDRÉS DEL RABANEDO

REFERENTE: **LABORATORIO**

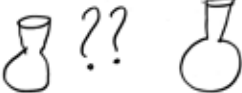
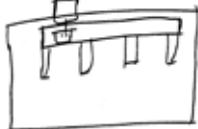
GRUPO: PROFESIONALES

<p>LABORATORIO</p> 	<p>LABORATORIO</p>  <p>TRABAJADOR</p>	<p>LABORATORIO</p>  <p><i>hoyada</i></p>	
<p>LABORATORIO</p> 	<p>LABORATORIO</p> 	<p>LABORATORIO</p> 	
<p>LABORATORIO</p> 	<p>LABORATORIO</p>  <p><i>Tarajá</i></p>	<p>LABORATORIO</p>  <p><i>Tarajá</i></p>	<p>LABORATORIO</p> 

CONCLUSIONES:

CRE - SAN ANDRÉS DEL RABANEDO

REFERENTE: **ESTANCIA DIURNA**

GRUPO: PROFESIONALES

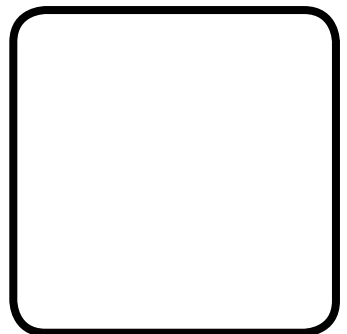
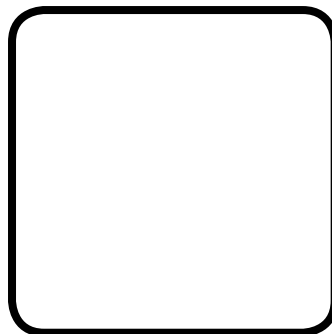
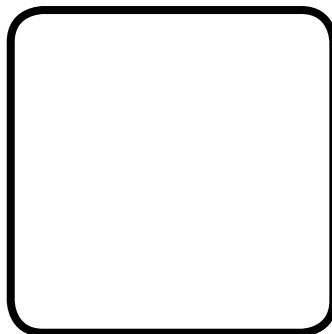
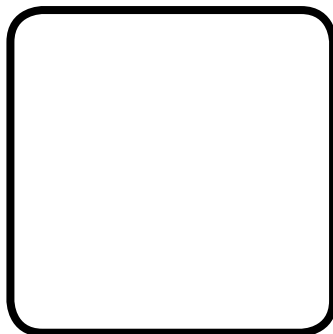
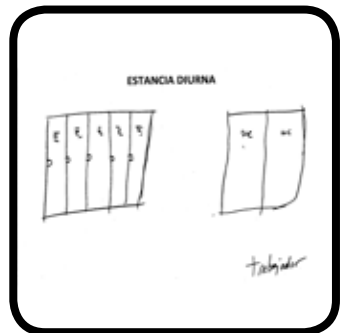
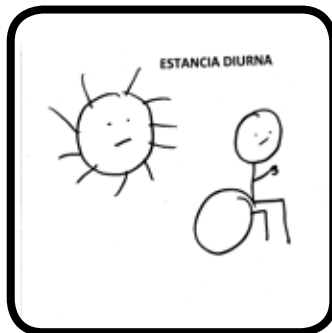
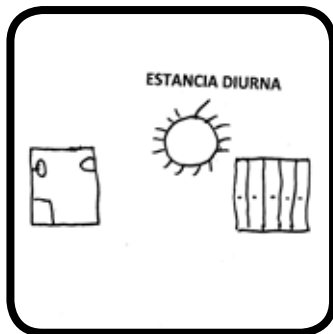
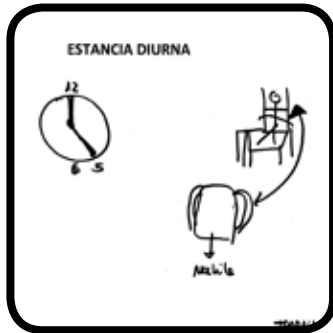

CONCLUSIONES:

CRE - SAN ANDRÉS DEL RABANEDO

REFERENTE: **SALA DE FISIOTERAPIA**

GRUPO: PROFESIONALES

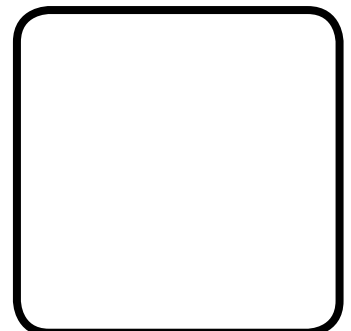
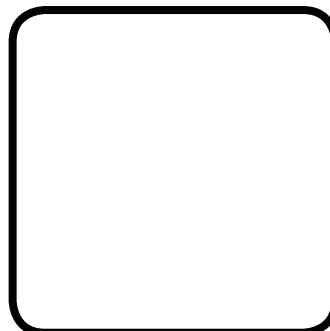
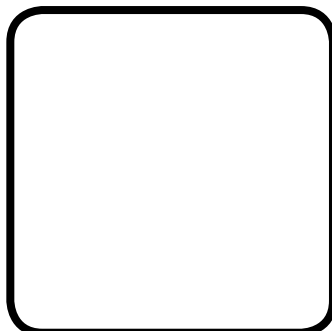
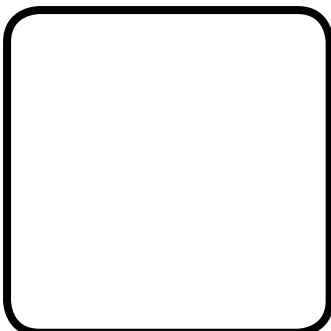
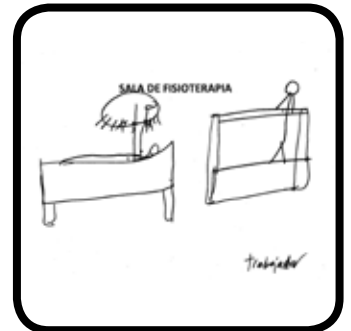
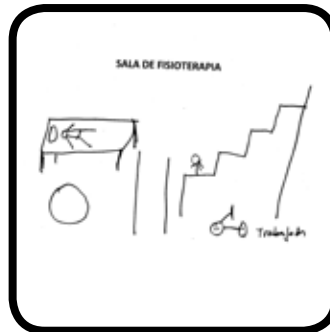
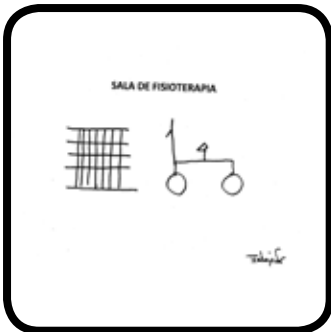

CONCLUSIONES:

CRE - SAN ANDRÉS DEL RABANEDO

REFERENTE: **SALA DE SNOEZELEN**

GRUPO: PROFESIONALES

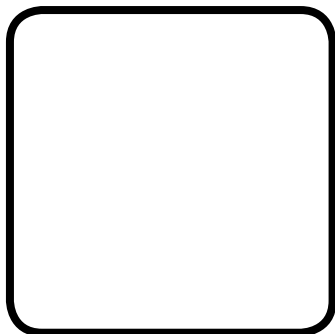
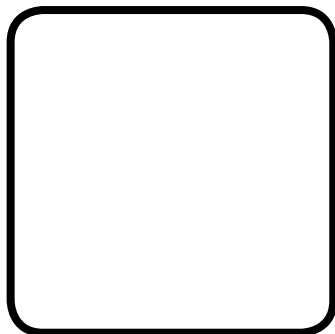
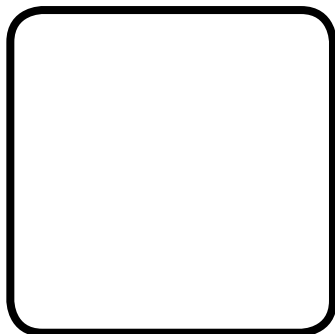
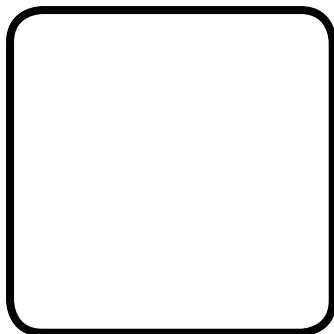
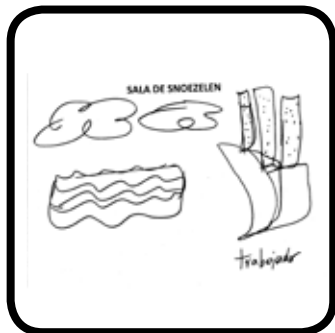
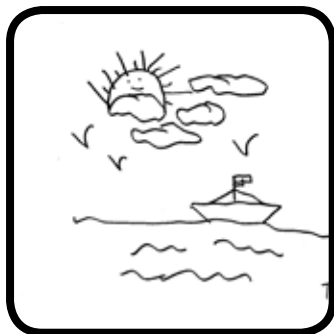
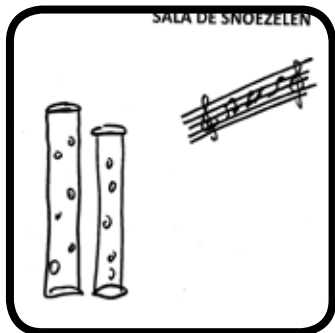

CONCLUSIONES:

CRE - SAN ANDRÉS DEL RABANEDO

REFERENTE: SALA TERAPIA OCUPACIONAL

GRUPO: PROFESIONALES

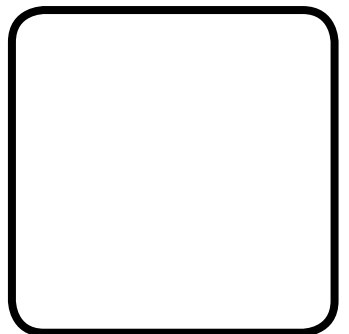
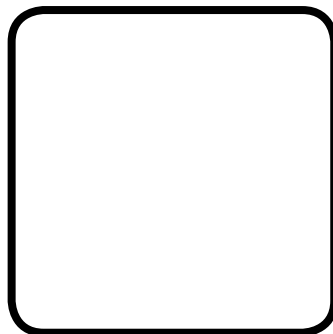
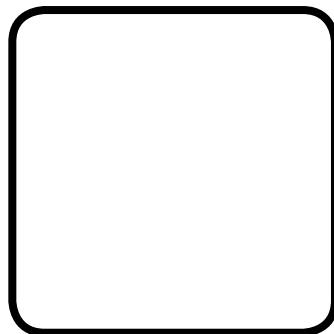
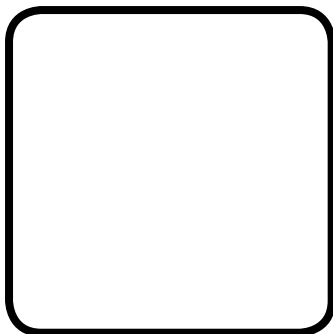
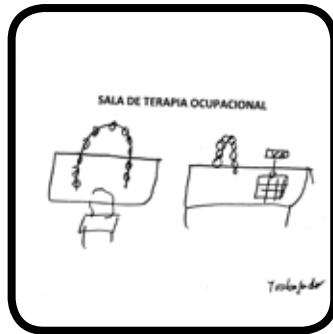

CONCLUSIONES:

CRE - SAN ANDRÉS DEL RABANEDO

REFERENTE: TALLER CREATIVO

GRUPO: PROFESIONALES

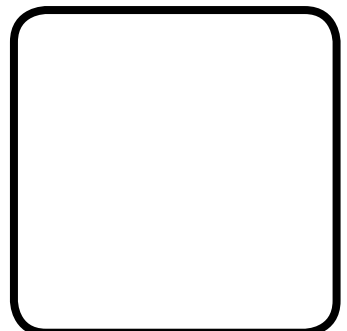
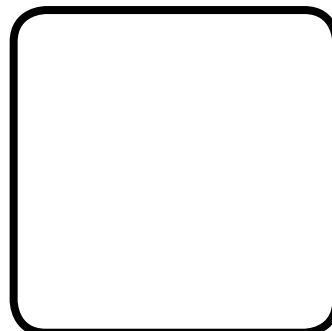
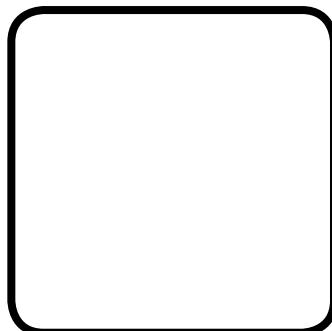
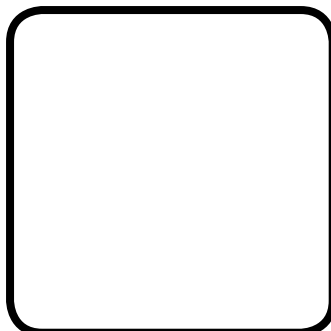
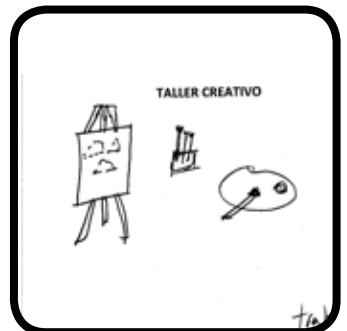
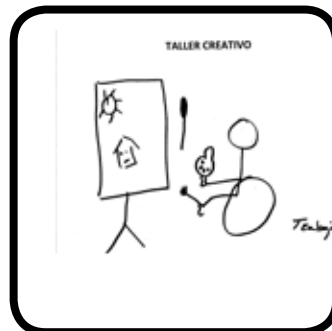
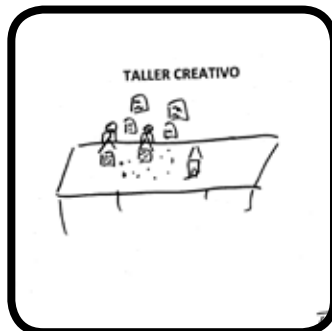
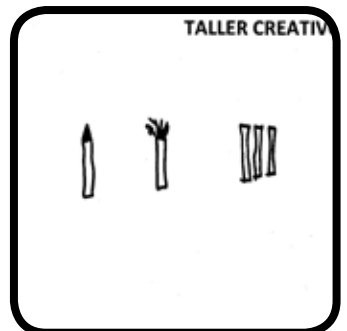
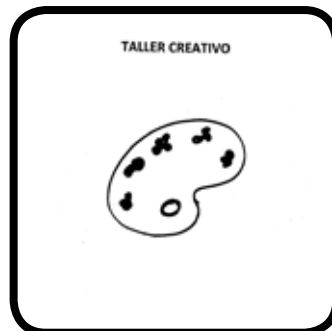
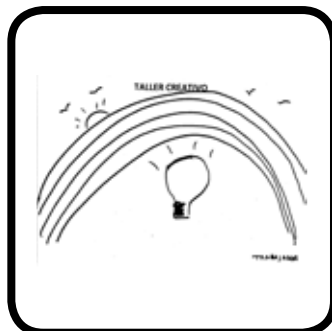
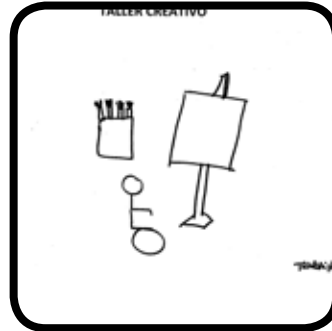

CONCLUSIONES:

CRE

LOCALIDAD: SAN ANDRÉS DEL RABANEDO

GRUPO: USUARIOS

CRE - SAN ANDRÉS DEL RABANEDO

REFERENTE: AULA DE DEPORTE

GRUPO: USUARIOS

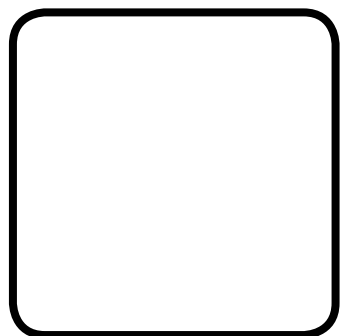
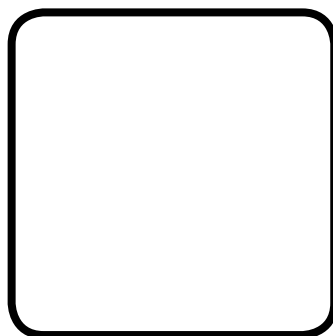
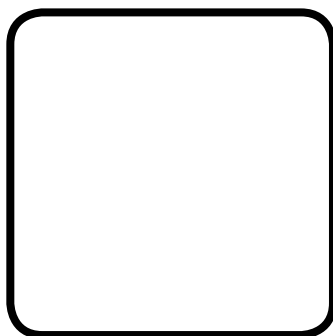
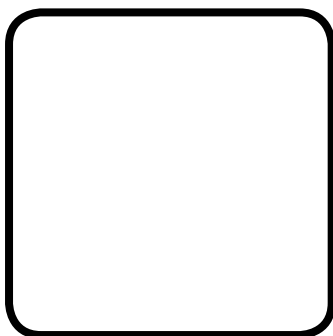
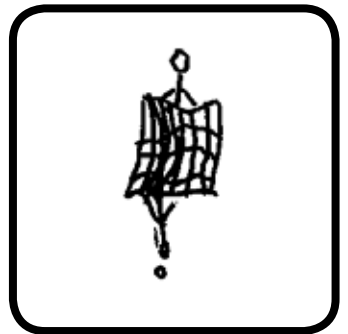
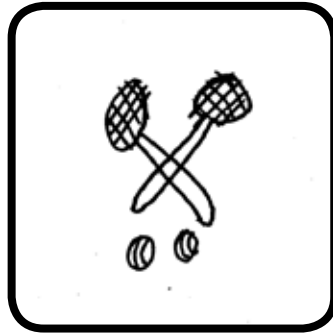

CONCLUSIONES:

CRE - SAN ANDRÉS DEL RABANEDO

REFERENTE: AULA DE EDUCACIÓN SOCIAL

GRUPO: USUARIOS

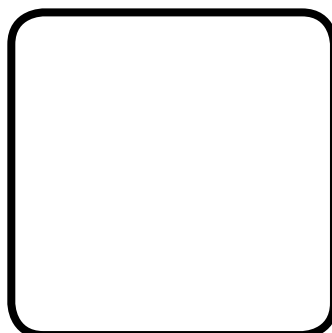
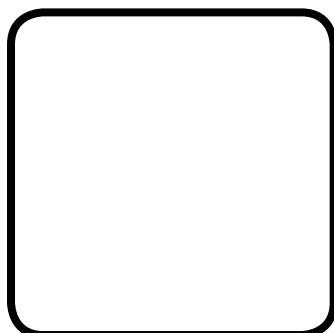
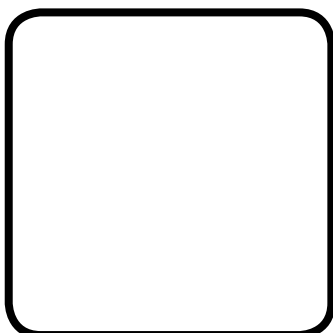
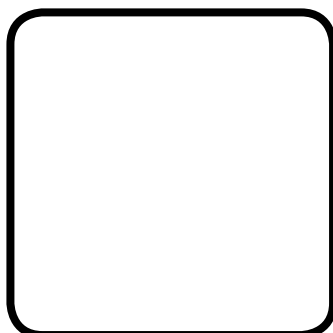
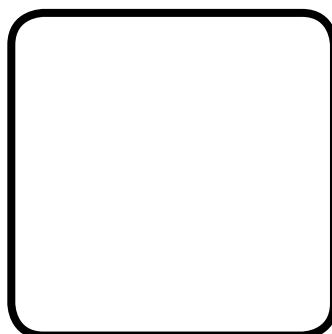
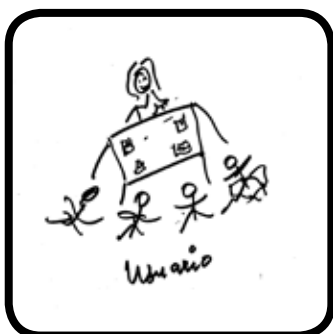
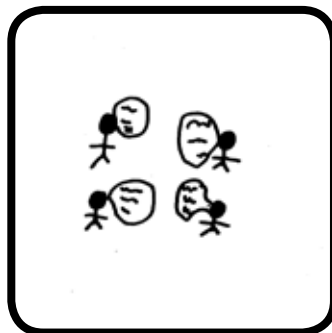

CONCLUSIONES:

CRE - SAN ANDRÉS DEL RABANEDO

REFERENTE: INFORMÁTICA

GRUPO: USUARIOS

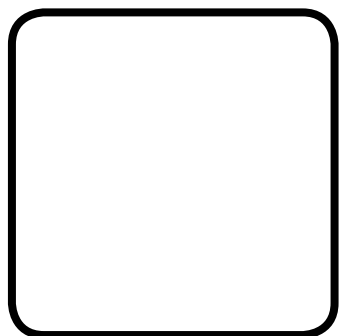
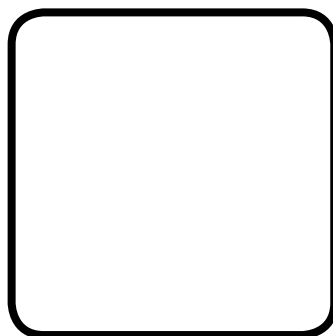
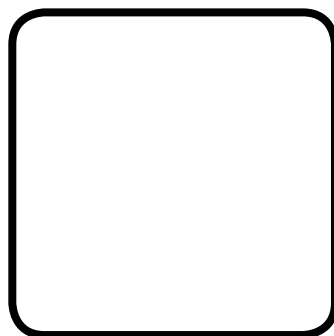
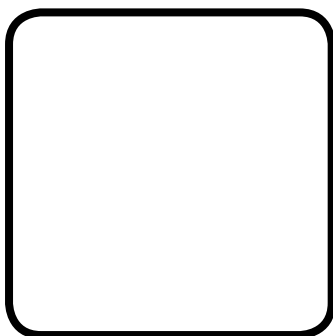
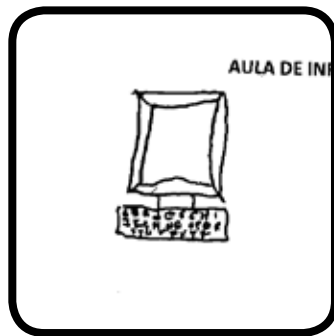
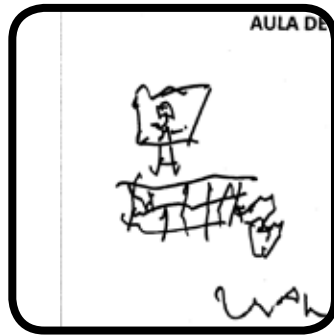

CONCLUSIONES:

CRE - SAN ANDRÉS DEL RABANEDO

REFERENTE: AULA DE LOGOPEDIA	GRUPO: USUARIOS
------------------------------	-----------------

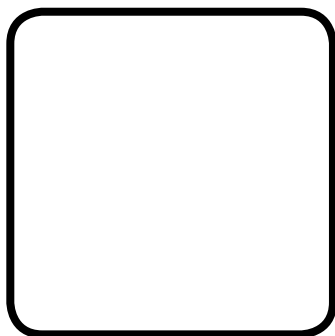
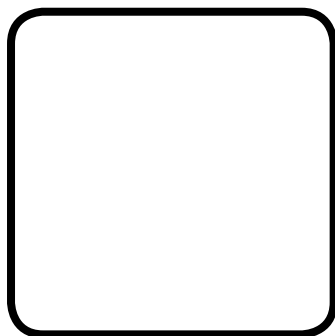
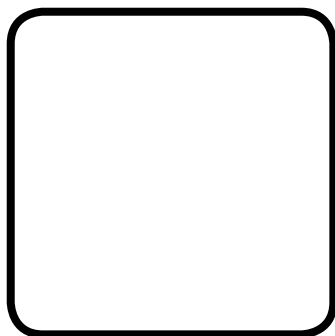
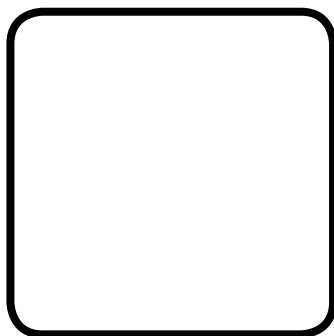
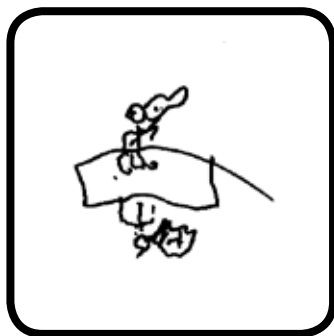
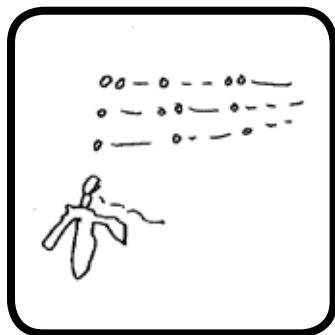
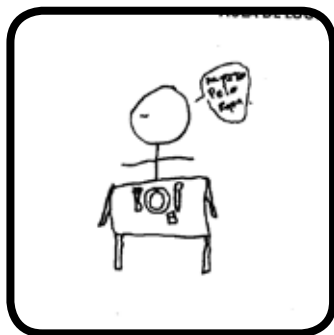
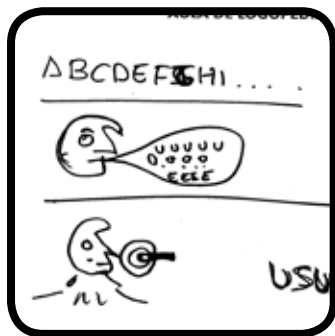

CONCLUSIONES:

CRE - SAN ANDRÉS DEL RABANEDO

REFERENTE: **LABORATORIO**

GRUPO: **USUARIOS**

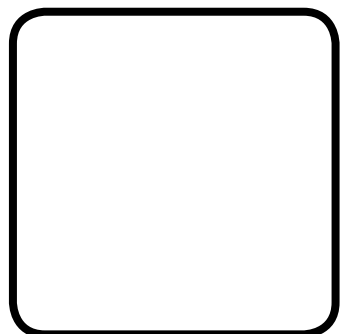
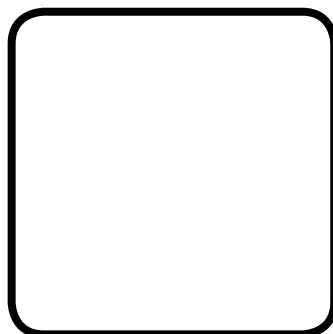
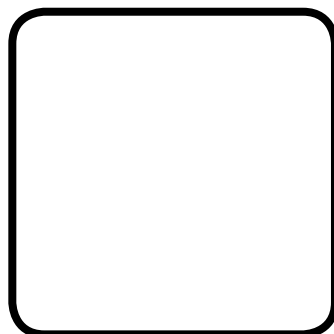
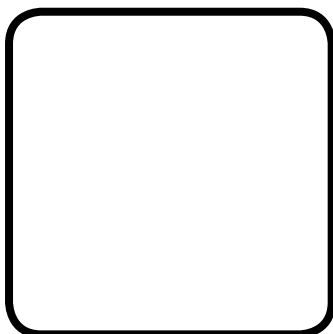
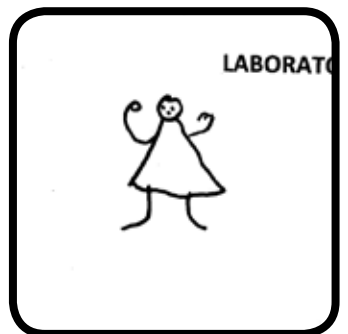
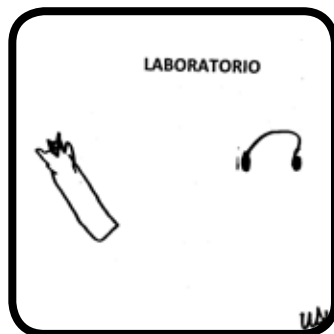
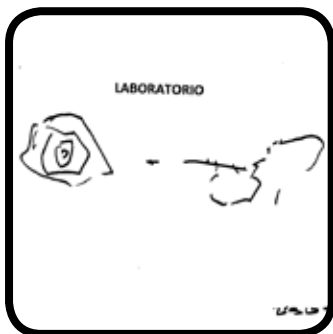
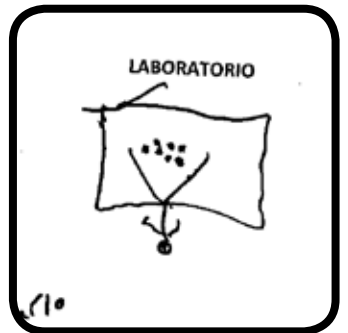
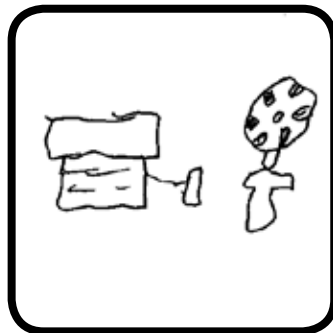
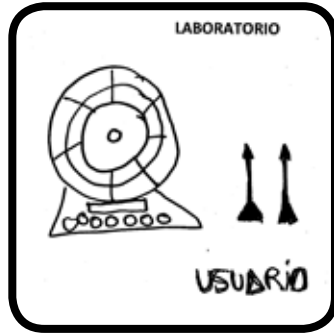
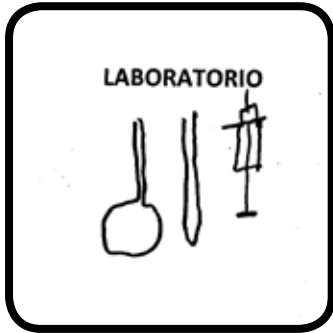

CONCLUSIONES:

CRE - SAN ANDRÉS DEL RABANEDO

REFERENTE: **ESTANCIA DIURNA**

GRUPO: **USUARIOS**

<p>ESTANCIA DIURNA</p>	<p>ESTANCIA DIURNA</p>	<p>ESTANCIA DIURNA</p>	<p>ESTANCIA DIURNA</p> <table border="1" style="float: right; margin-top: 10px;"> <tr><td>0.5</td><td>0.4</td></tr> <tr><td>0.6</td><td>0.3</td></tr> <tr><td>0.7</td><td>0.2</td></tr> <tr><td>0.8</td><td>0.1</td></tr> </table>	0.5	0.4	0.6	0.3	0.7	0.2	0.8	0.1
0.5	0.4										
0.6	0.3										
0.7	0.2										
0.8	0.1										
	<p>ESTANCIA DIURNA</p>	<p>ESTANCIA DIURNA</p>	<p>ESTANCIA DIURNA</p> <p>USUARIO</p>								
	<p>ESTANCIA DIURNA</p>	<p>ESTANCIA DIURNA</p>	<p>ESTANCIA DIURNA</p>								

CONCLUSIONES:

CRE - SAN ANDRÉS DEL RABANEDO

REFERENTE: **SALA DE FISIOTERAPIA**

GRUPO: **USUARIOS**

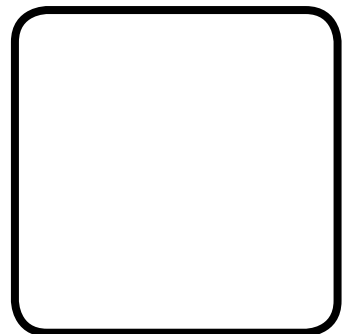
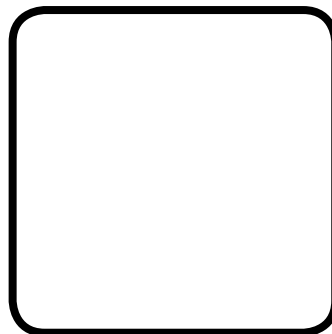
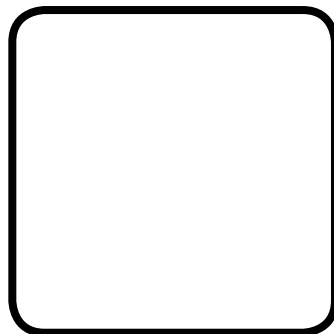
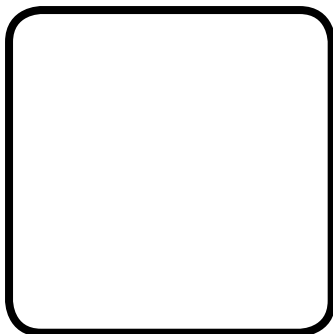
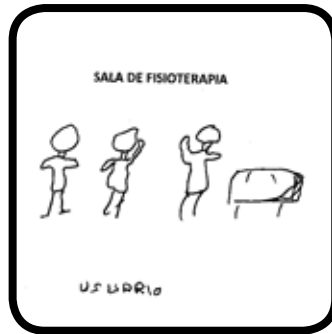

CONCLUSIONES:

CRE - SAN ANDRÉS DEL RABANEDO

REFERENTE: **SALA DE SNOEZELEN**

GRUPO: **USUARIOS**

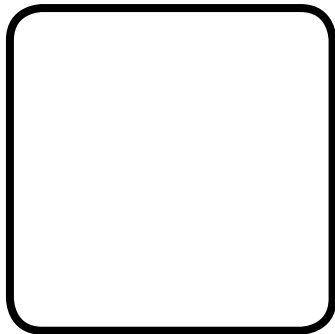
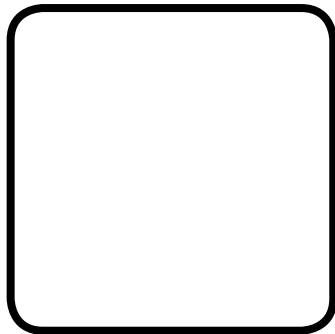
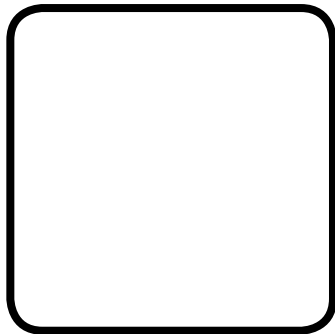
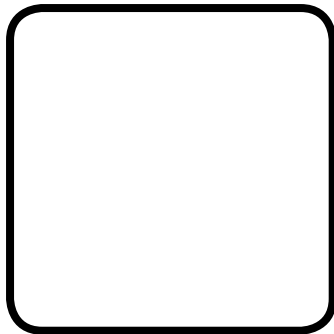
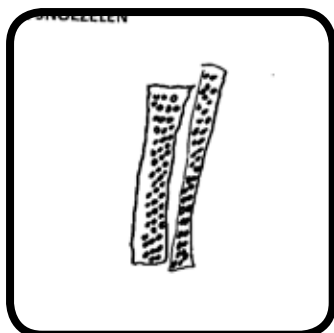

CONCLUSIONES:

CRE - SAN ANDRÉS DEL RABANEDO

REFERENTE: TALLER CREATIVO	GRUPO: USUARIOS
----------------------------	-----------------

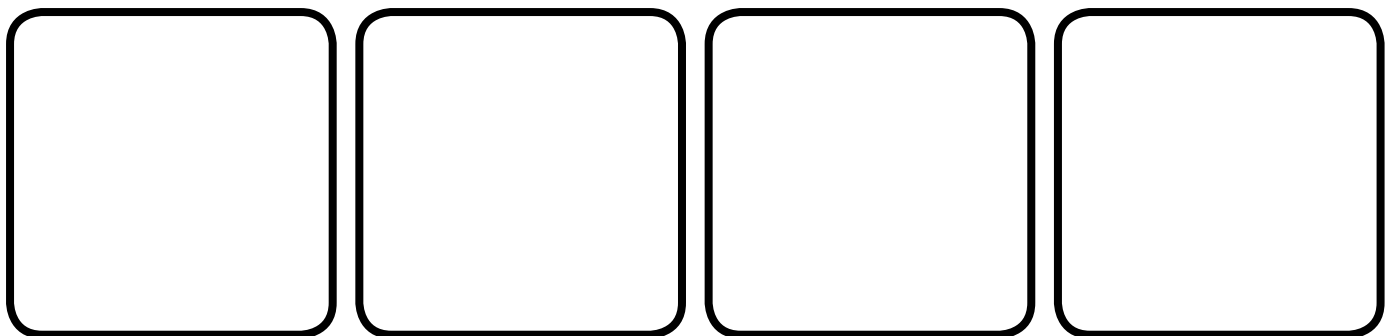
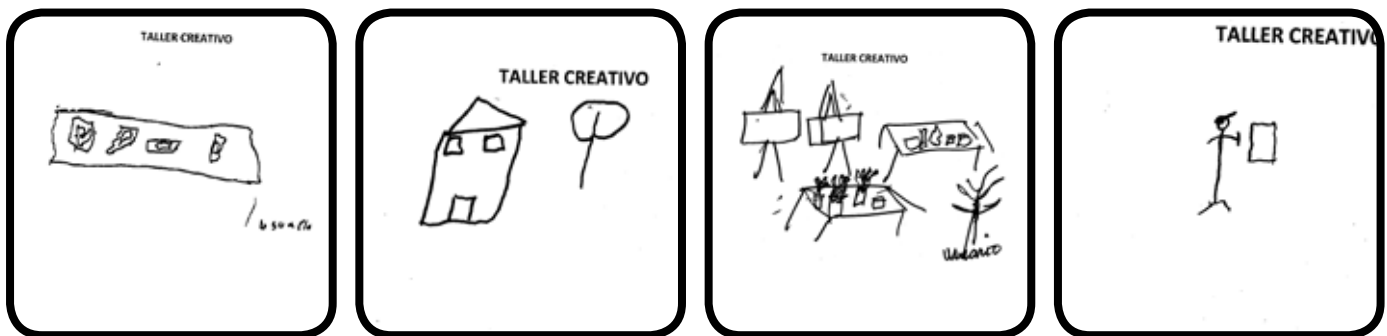
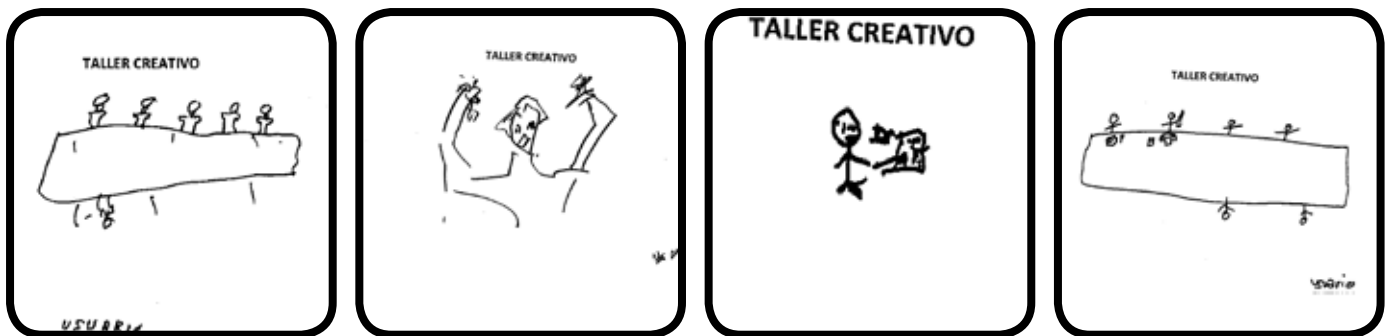
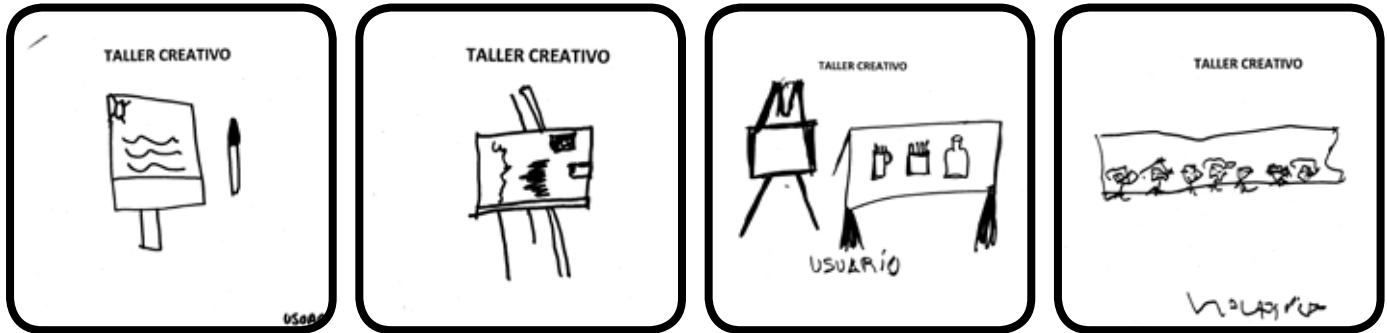

CONCLUSIONES:

ANEXO 2

Pictogramas de señalización validados para centros de personas con discapacidad del IMSERSO y centro de atención al peregrino de Santiago de Compostela.

**Pictogramas
validados finales
para Centros
del IMSERSO**

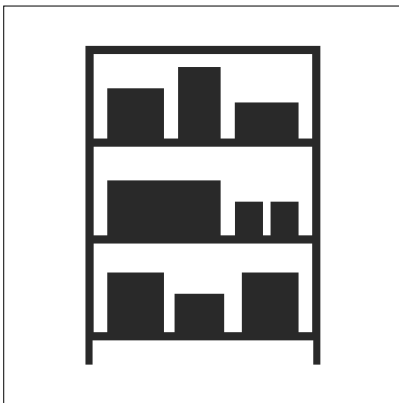

Almacén

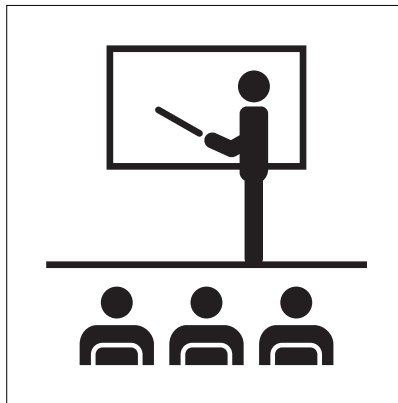

Aula de formación

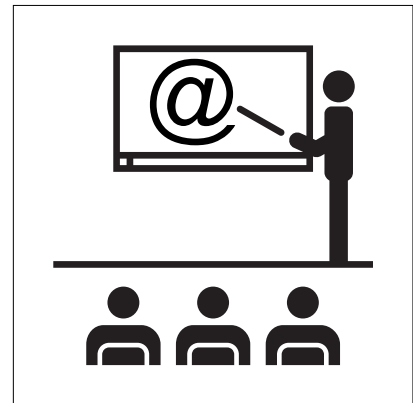

Aula de informática

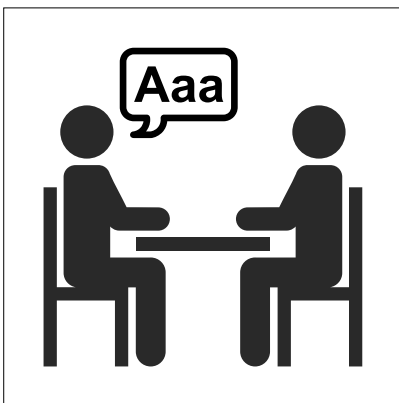

**Aula de logopedia/
audición y lenguaje**

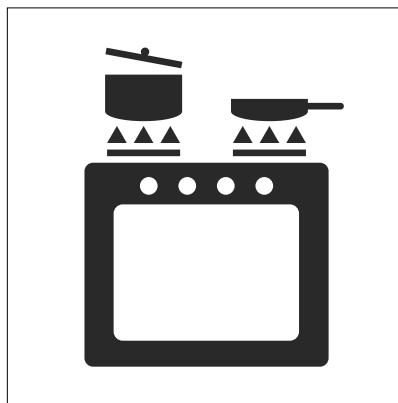

Cocina

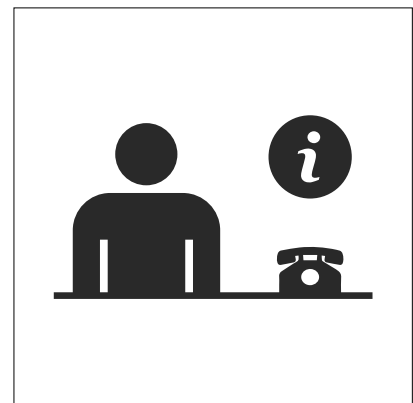

Conserjería

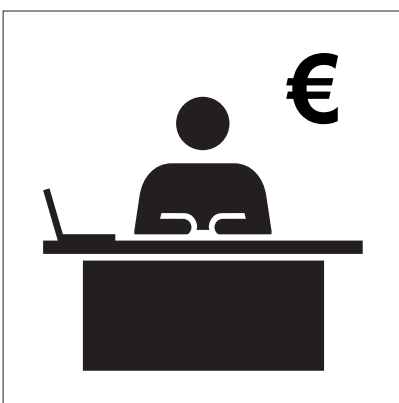

Despacho administrador

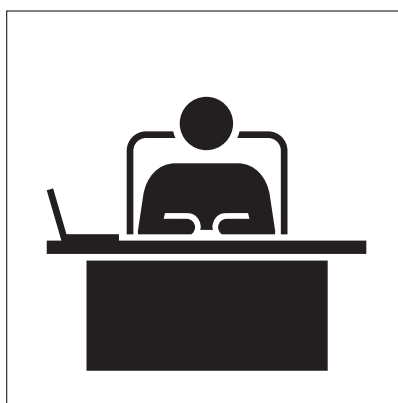

Despacho director



Gobernanta



Jefe de estudios

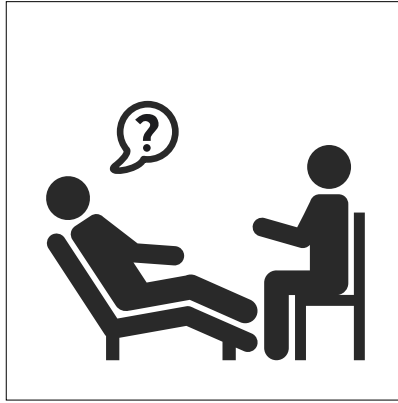

Despacho psicólogo

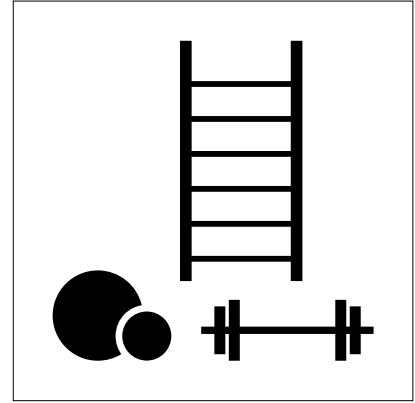

Gimnasio



Lavandería

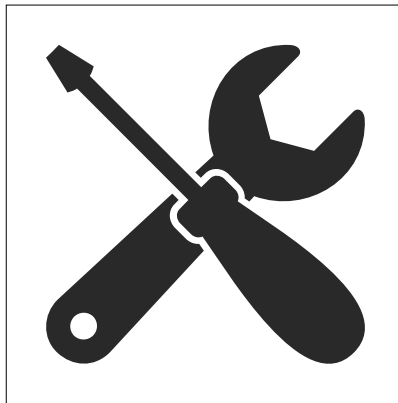

Mantenimiento



Sala polivalente/
Pabellón multiusos

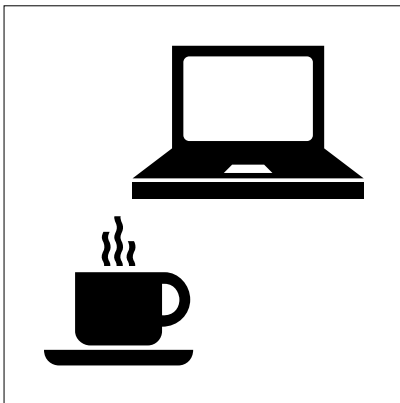

Sala de cuidadores

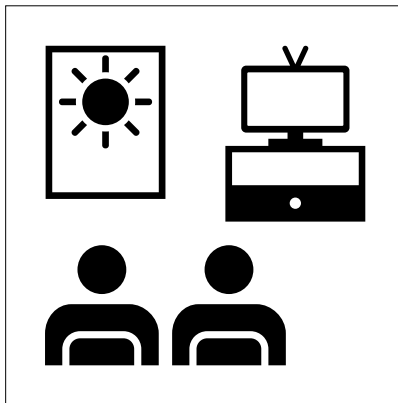

Sala estancia diurna/
Sala de estar

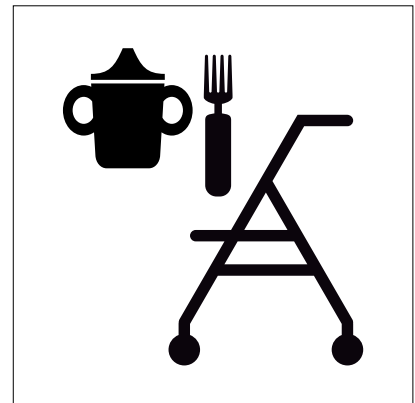

Sala de exposición de
productos de apoyo



Sala Snoeselen

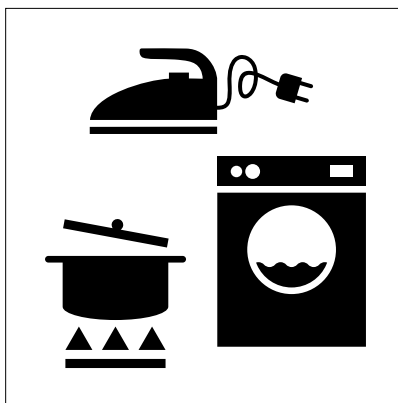

Actividades diarias



Sala terapia ocupacional



Taller creativo

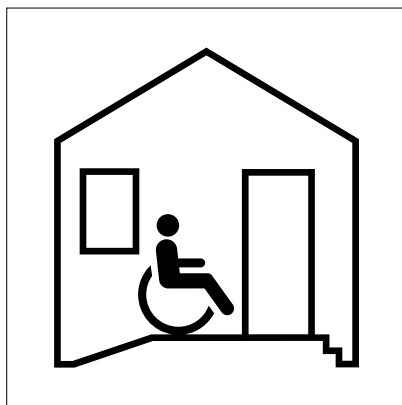

Vivienda adaptada

Pictogramas validados finales para Oficina de Atención al Peregrino de Santiago de Compostela



Oficina de grupos



Oficina de viajes



Atención al peregrino

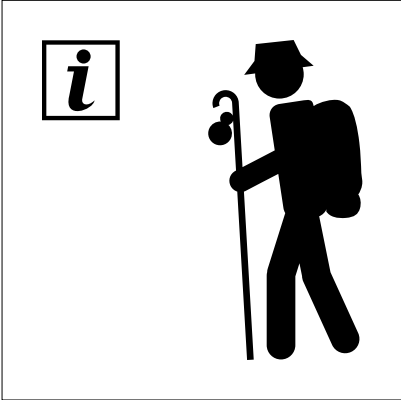

Oficina de turismo

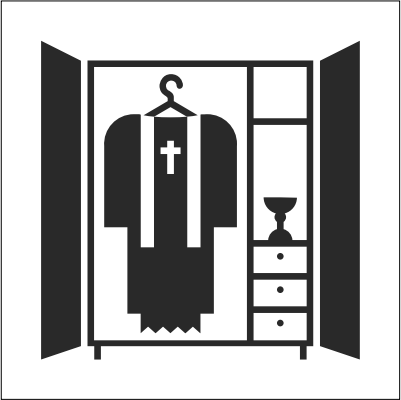

Sacristía



Información

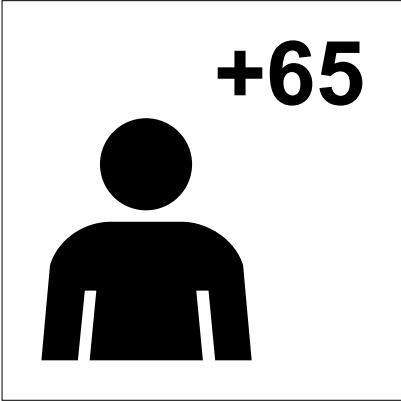

Mayores

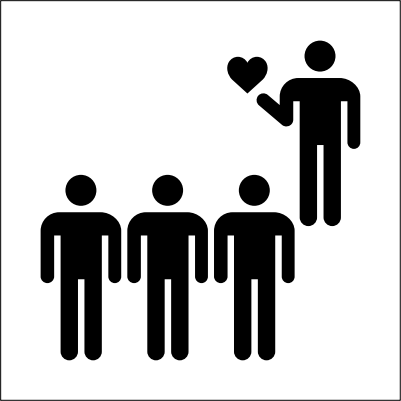

Voluntariado

**Pictogramas
modificados a
partir de modelos
preexistentes**



Cafetería

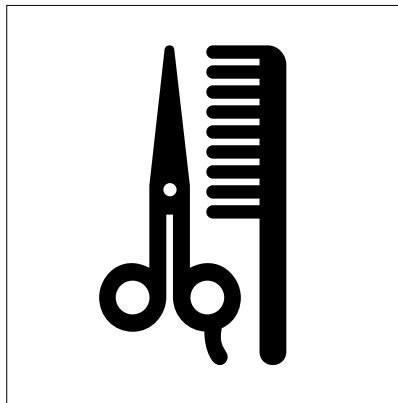

Peluquería



Peluquería hombres



Peluquería mujeres

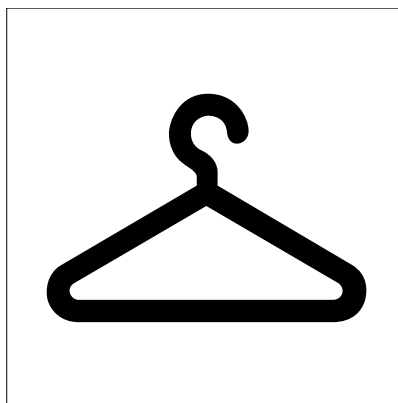

Guardarropa



Vestuario hombres



Vestuario mujeres

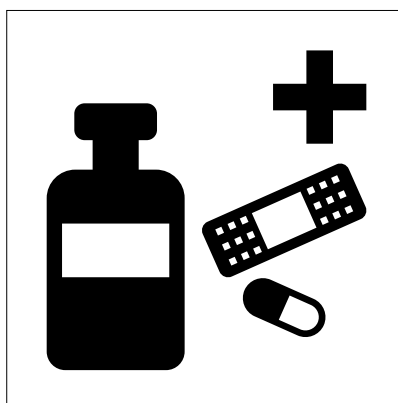

Sala de enfermería



Biblioteca

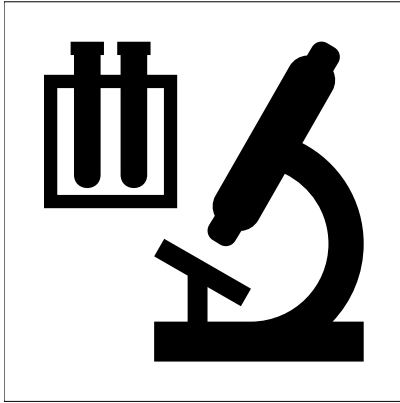

Laboratorio

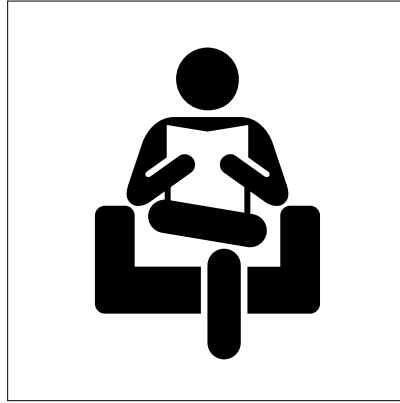

Sala de espera

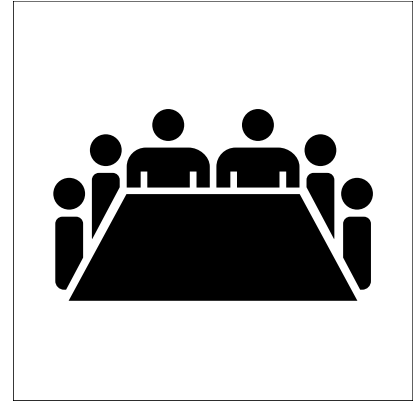

Sala de reuniones

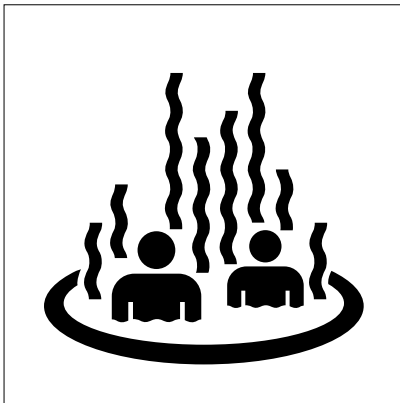

Termalismo



Registro



Dormitorio

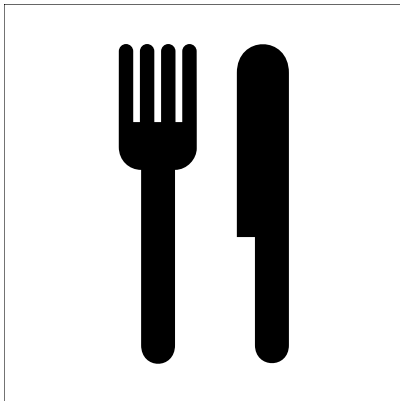

Comedor/ Cafetería



Despacho médico

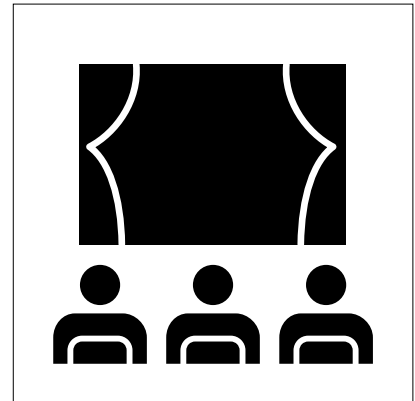

Salón de actos



Aula de deporte



Conserjería

